

"JOIN THE CLUB" AND BE SOMEONE VERY SPECIAL!

As the proud owner of a Winnebago or Itasca brand motor home, you are eligible to belong to the Winnebago-Itasca Travelers Club (WIT). WIT offers the opportunity to share friendship and fun with people like yourself—special people—for whom travel and adventure have become a way of life...people who are drawn to the open road and the chance to explore the world around them.

Come along to share the camaraderie and companionship

For many, the best thing about WIT is the goodwill and fellowship that develops among members of this exclusive club. There's something for everybody. Special groups exist within WIT for people with travel-related interests: Amateur Radio Club, the 365 Club (for members who spend 6 months of each year in their unit), Handicapped Club, Traveling Squares (for those who enjoy square dancing), WIT-LEO (for all present and former law enforcement officers) and Singles Club. Those who seek activity can play bingo, hike, pitch horseshoes and more. Those who wish to relax may just want to sit around the campfire swapping tales.

No matter how frequently you travel, WIT can be of service

Whether you travel one weekend a month or every day of the year, you'll benefit from the many conveniences and services WIT offers: membership directory, monthly club magazine, KOA discount card, trip routing, 10% discount at Winnebago Customer Service on parts and catalog sales, opportunities to purchase personal RV insurance, long term convalescence care insurance, and merchandise, access to TTS (WIT's emergency road service), mail forwarding and more to come!

We'll make all the plans for trips to near and far

As a WIT member, you'll be invited to attend local outings and state rallies. The Grand National Rally is held each year at Forest City, Iowa. For those on the move WIT sponsors a number of caravans and tours each year to exciting places. WIT members travel together in the comfort and convenience of their own motor homes, headed by profes-

sional tour directors who handle all the arrangements.

WIT offers the first of its kind Emergency Road Service

WIT has joined with TTS, long known as the "AAA" of the trucking industry, to bring to the No. 1 Owners' Club the success and experience of the leader in the emergency road service. Fast service is provided from more than 7,000 locations nationwide including Canada and Alaska through a toll-free "800" phone service.

Send in your application now and become a member of our exclusive club

Add to the enjoyment of your motor home and your leisure time by joining this friendly, active group. Simply fill out the application form and send it to us with your check or money order, or charge it to your VISA or MasterCard. Your name will be added to our list of very special people and you'll begin immediately to reap the benefits of membership in the Winnebago-Itasca Travelers Club.

APPLICATION FOR MEMBERSHIP WINNEBAGO-ITASCA TRAVELERS

P.O. Box 268 Forest City, Iowa 50436 Phone (515) 582-6874

(PLEASE PRINT)

Name _____ Companion's or Spouse's name _____

Address _____

City _____ State _____ Zip _____

Telephone: (____) _____

METHOD OF PAYMENT

Personal check or money order VISA MasterCard

Card No.: _____ - _____ - _____ Expiration date: _____

Signature _____ Date _____

TYPE OF UNIT:

WIT must have coach serial number (begins with 10 or 70 and has 11 or 12 digits)

Serial No.: _____ Year _____ Model _____

NEW MEMBERSHIP

Dues of \$30 for 1 year Dues of \$50 for 2 years Dues of \$65 for 3 years

REINSTATEMENT OF WIT No. _____

Dues of \$25 for 1 year Dues of \$45 for 2 years Dues of \$60 for 3 years

MEMBERSHIP SPONSORED BY:

Name _____ WIT No. _____

TO THE OWNER

Congratulations! We welcome you to the exciting world of motor home travel and camping. You will find it convenient and enjoyable to have all the comforts of home and still enjoy the great outdoors, wherever you choose to go.

Your motor home has been carefully designed, engineered and manufactured to provide dependability as well as safety. Before sliding into the driver's seat, take a few minutes to become familiar with operations and features. This manual was prepared to aid you in the proper care and operation of the vehicle and equipment. We urge you to read it completely. In addition, spend some time with the dealer when you take delivery, you will want to learn all you can about your new motor home.

Your Itasca motor home is covered by a factory warranty against defects in material and workmanship. This warranty should be validated at once and returned to the factory by your dealer.

Throughout this manual, reference is made to the following terms: Important, Caution and Warnings. These terms indicate important information which must be understood and followed. The definitions of these terms are:

IMPORTANT

Indicates a special point of information.

CAUTION
Indicates a failure to observe can cause damage to equipment.

WARNING
Indicates that failure to observe can cause personal injury or death and possible damage to equipment.

OWNER'S NAME

STREET ADDRESS

CITY AND STATE (OR PROVINCE IN CANADA)

MOTOR HOME SERIAL NUMBER

VEHICLE CHASSIS IDENTIFICATION NO. (VIN)

DATE OF DELIVERY TO FIRST RETAIL PURCHASER

VEHICLE MILEAGE AT TIME OF SUCH DELIVERY

SELLING DEALER NAME AND ADDRESS

TABLE OF CONTENTS

INTRODUCTION

Chassis Operating Operating Guide.....	i
Motor Home Operations Manual (Binder).....	i
Before Driving	i
Service Assistance	i
Drinking and Driving	ii
Reporting Safety Defects	ii
Vehicle Certification Label.....	iii
Exterior Feature Identification	iv

SECTION 1: SAFETY PRECAUTIONS

General Warnings.....	1-1
Driving.....	1-1
Fuel & LP Gas.....	1-1
LP Gas Leaks.....	1-2
LP Leak Gauge	1-2
Electrical	1-3
Loading	1-3
Maintenance	1-3
Formaldehyde Warning.....	1-4
Carbon Monoxide Warning	1-4
Emergency Exit Window.....	1-4
Safety Devices	
Fire Extinguisher	1-5
Smoke Alarm.....	1-5

SECTION 2: DRIVING YOUR MOTOR HOME

Before Entering	2-1
Before Driving	2-1
Keys.....	2-1
Fuel Selection	2-1
Gasoline Fuel Fill.....	2-2
Fuel Tank Capacity.....	2-2
Starting and Stopping Engine.....	2-2
Parking the Vehicle.....	2-2
Parking on a Hill	2-2
Parking Brake	2-2
Hazard Warning Lights.....	2-2
Fuel Pump Shut-Off Switch.....	2-2
Door Locks and Handles.....	2-3
Entrance Step.....	2-4
Seats	2-4
Seat Belts	2-5
Child Restraints.....	2-6
Mirrors.....	2-6
Rear Vision Camera/Monitor System.....	2-6
Instrument Panel	2-7
Windshield Wiper/Washer Switch	2-9,2-10
Speed Control (Cruise)	2-9
Comfort Controls	2-10, 2-11
Heating	2-11
Defrosting.....	2-11
Ventilation.....	2-11
Air Conditioning	2-11
Rear Auto Heater	2-11
Radio/Cassette Player.....	2-11
Radio Switch.....	2-11

Vacuum/Fuel Economy Gauge.....	2-11
Battery Mode Switch	2-12
Map Light.....	2-12
Auxiliary Fan Switch.....	2-12
Air Horns	2-12
Coach Leveling System	2-12
Jet Air Ride Suspension.....	2-13
Manual Coach Stabilizers	2-14

SECTION 3: IN CASE OF DRIVING EMERGENCY

Hazard Flashers	3-1
Spare Tire	3-1
Tire Changing	
Safety Precautions	3-1
Front Wheel	3-1
Dual Rear Wheels.....	3-2
Wheel Nuts	3-2
Recovery Towing !.....	3-2
Jump Starting.....	3-3
Connecting a Battery Charger	3-4
Engine Overheat	3-4

SECTION 4: TRAVELING WITH YOUR MOTOR HOME

Loading the Vehicle.....	4-1
Roof Loading.....	4-1
Trailer Towing.....	4-1
Pre-Travel Checklist.....	4-2
Equipping For Travel	
Emergency Equipment Checklist.....	4-2
Quick Loading Checklist.....	4-2
Travel Tips	4-3
Humidity and Condensation.....	4-4
Severe Weather Information.....	4-4
Nighttime Driving	4-5
Mountain Driving.....	4-5
Campsite Selection	4-5
Leveling.....	4-5
Blocking	4-5

SECTION 5: LP GAS SYSTEM

LP Gas Supply.....	5-1
Safe Use of LP Gas System	5-1
How LP Gas Works.....	5-1
Selecting Fuel Types	5-1
LP Gas Output.....	5-1
LP Tank System	5-2
Refilling Tank	5-2
Air in the LP Gas Tank.....	5-2
Traveling with LP Gas	5-2
Regulator	5-3
LP Gas Leaks	5-3
LP Leak Gauge	5-4
Winter Use of LP Gas.....	5-5

SECTION 6: ELECTRICAL SYSTEMS

110-Volt AC System	6-1
External Power Cord (Shoreline)	6-1
Power Converter	6-1

Charging Section..... 6-2
 Thermal Breaker..... 6-2
 110-Volt Circuit Breakers..... 6-3
 110-Volt Receptacles (Outlets)..... 6-3
 Ground Fault Circuit Interrupter (GFCI)..... 6-3
 Auxiliary 110-Volt Generator
 Operating Instructions..... 6-3, 6-4
 12-Volt DC System..... 6-5
 12-Volt Fuses and Circuit Breakers..... 6-5
 Auxiliary (Coach) Battery..... 6-5
 Battery Maintenance..... 6-6
 Auxiliary Battery Disconnect Switch..... 6-7

SECTION 7: PLUMBING SYSTEMS

Fresh Water System..... 7-1
 Filling Water Tank..... 7-1
 Fresh Water Tank Capacity..... 7-1
 Water Pump..... 7-2
 Water Pump Switch..... 7-2
 Disinfection of Water Tank..... 7-2
 External (City Water) Connector..... 7-3
 Flushing External Water Hook-Up..... 7-3
 Shower Hose Vacuum Breaker..... 7-3
 Drainage System (Waste)..... 7-4
 Dumping Holding Tanks..... 7-4
 Using On-Site Sewer Hook-Ups..... 7-5
 Holding Tank Level Indicators..... 7-5
 Holding Tank Capacities..... 7-5
 Water Drain Valves..... 7-5
 Water System Drain Valve Locations..... 7-5

SECTION 8: APPLIANCES

Refrigerator..... 8-1
 Ice Maker..... 8-2
 Range and Oven..... 8-5
 Lighting Range Top Pilot..... 8-6
 Lighting Oven Pilot..... 8-6
 Microwave Oven..... 8-7
 Monitor Panel..... 8-7
 Water Heater..... 8-8
 Water Heater Capacity..... 8-9
 Water Heater By-Pass Valve..... 8-9
 Motor Aid Water Heater..... 8-9
 LP Gas Furnace..... 8-10
 Roof Air Conditioner..... 8-10
 Air Conditioner Selector Switch..... 8-10
 TV Antenna..... 8-10
 TV Signal Amplifier..... 8-11
 Cable TV Hook-Up..... 8-11

SECTION 9: INTERIOR FEATURES AND FURNISHINGS

Sleeping Facilities
 Front Pull-Down Bunk..... 9-1
 Couch/Bed Conversions..... 9-1
 Dinette/Bed Conversion..... 9-1
 Fresh Water Toilet..... 9-1, 9-2
 Power Roof Vent..... 9-3
 Crank-Out Windows..... 9-3

SECTION 10: CARE AND MAINTENANCE

Roof..... 10-1
 Underbody..... 10-1
 Exterior..... 10-1
 Compartment Doors..... 10-1
 Interior Maintenance
 Upholstery, Carpeting and Draperies..... 10-1
 Cabinets..... 10-2
 Tables and Countertops..... 10-2
 Stainless Steel Sink..... 10-2
 Range and Refrigerator..... 10-2
 Bathroom..... 10-2
 Washerless Faucet O-Rings..... 10-3
 Doors and Windows..... 10-3
 Roll-Up Window Shade Adjustment..... 10-3
 Pleated Window Shade Adjustment..... 10-3
 Vehicle Maintenance
 Chassis Service and Maintenance..... 10-3
 Engine Access..... 10-3
 Engine Cooling System..... 10-4
 Tires..... 10-4
 Suspension Alignment and Tire Balance..... 10-4
 4-Way Front Stabilizer Shocks..... 10-4
 Rear Air Springs..... 10-4
 Lights..... 10-5
 Care of Optional Aluminum Wheels..... 10-5
 Rear Tag Axle Information..... 10-5
 Automotive Circuit Breakers..... 10-6

SECTION 11: STORING AND WINTERIZING

Preparing Vehicle For Storage..... 11-1
 Cold Weather Storage (Winterizing)..... 11-1
 Removal From Storage..... 11-3

INTRODUCTION

Congratulations on the purchase of your new Itasca motor home, which has been carefully designed, engineered and quality built by Winnebago Industries, Inc.

Operator's Manual

Please read this operator's manual thoroughly. It was prepared in order to provide you with information necessary to properly and safely operate your new motor home.

This manual describes those instruments, controls and instructions which are unique to Itasca motor homes. For information regarding all other equipment, controls and instructions not described herein, we urge you to read the "Chassis Operating Guide" and the equipment manufacturer's information provided in your "Motor Home Operation Manual".

This manual should be kept in the vehicle at all times for personal reference. The operator's manual, motor home operation manual and chassis operating guide are to be considered permanent components of this vehicle. They should remain in the vehicle when sold to provide the next owner with important safety, operating and maintenance information.

NOTE:

The descriptions, illustrations, and specifications in this manual were correct at the time of printing. We reserve the right to change specifications or design without notice, and without incurring obligation to install the same on products previously manufactured.

Chassis Operating Guide

Throughout this manual, frequent reference is made to the vehicle chassis operating guide. The chassis guide is the operator's manual provided by the manufacturer of the chassis on which this motor home is built (i.e., Chevrolet, Ford, etc.). Consult the chassis guide for operating safety and maintenance instructions pertaining to the chassis section of the motor home.

Motor Home Operation Manual (Binder)

Your Motor Home Operation Manual contains information supplied by manufacturers of individual appliances and equipment installed in your motor home.

Consult this information regarding the operation and care of appliances, accessories and special equipment.

Options and Equipment

Since Itasca motor homes are available in many models and sizes, accessories and components may differ between models. Therefore, some equipment described in this manual may not apply to your vehicle.

Before Driving

Before entering the driver's seat, always check around your vehicle in all directions to assure that you have proper clearance in order to avoid minor accidents. When backing up, be positive there is nothing behind your vehicle. As an extra precaution, have a passenger check the area around your vehicle as you maneuver out of a difficult parking space.

Even though your motor home has been equipped with automotive features such as power steering and power brakes, driving a motor home requires a somewhat different handling technique than driving an automobile. When driving your motor home, always remember that the weight, length, width and height are greater than that of an automobile. A motor home requires greater stopping distance, more parking space, more maneuvering space and more acceleration time when passing other vehicles than does an automobile.

Always be aware of the dimensions of your motor home. Tunnels, low hanging canopies and signs in service stations and restaurants can cause clearance problems. Keep in mind the added height of any options on the roof such as air conditioner units, TV antennas or luggage boxes. Also, remember that certain bridges, old ones in particular, may not accept the weight of your motor home. Always observe any posted weight limits.

When planning a trip to another state, write to the Chamber of Commerce of the state capital for information on state laws pertaining to RV's.

Remember: Always use your seat belt and instruct your passenger's to do so as well. Frequent rest stops while traveling are advised to relieve stress on the driver, passengers and the vehicle.

Service and Assistance

Your dealer will be glad to provide any additional information you need, as well as answer any questions you might have about operating the equipment in your motor home. When it comes to service, remember that your

dealer knows your vehicle best and is interested in your satisfaction. Your dealer will provide quality maintenance and any other assistance that you may require during your ownership of this vehicle.

If you need warranty repairs while traveling, however you may take your motor home to any Winnebago or Itasca dealership and they will assist you.

Warranty

Your new vehicle is covered by a factory warranty against defects in material and workmanship. This warranty should be validated immediately and returned to the factory by your dealer. For additional information, see your "New Vehicle Limited Warranty" included with this vehicle.

DRINKING AND DRIVING

Winnebago Industries supports the recommendations of the Presidential Commission on Drunk Driving.

- Exercise your good judgement and encourage others to do the same.
- Know the legal limits and do not exceed them.
- Also know your personal limits, which may be lower than the legal limits.
- Should you ever exceed your limits, find alternative transportation; call a cab, ask a friend to drive you home or call a family member to come and get you.

The presence of alcohol in significant levels in the blood increases the probability that the driver will be involved in an accident.

Reporting Safety Defects

If you believe that your vehicle has a defect which could cause a crash or could cause injury or death, you should immediately inform the National Highway Traffic Safety Administration (NHTSA) in addition to notifying Winnebago Industries, Inc.

If NHTSA receives similar complaints, it may open an investigation, and if it finds that a safety defect exists in a group of vehicles, it may order a recall and remedy campaign. However, NHTSA cannot become involved in individual problems between you, your dealer, or Winnebago Industries.

To contact NHTSA, you may either call the Auto Safety Hotline toll-free at 1-800-424-9393 (or 366-0123 in Washington, D.C. area) or write to: NHTSA, U.S. Department of Transportation, Washington, D.C. 20590. You can also obtain other information about motor vehicle safety from the Hotline.

VEHICLE CERTIFICATION LABEL

This label contains vehicle identification and other important reference information. The vehicle certification label is located on the driver's door. Never remove or destroy this label.

		INCOMPLETE VEHICLE MANUFACTURED	
		BY 1 MOTORS CORP.	
3	MONTH AND YEAR OF MANUFACTURE: 2		
GAWR:		GVWR 4 LB. _____ KG	
SUITABLE TIRE AND RIM CHOICE		COLD INFLATION PRESSURE	
TIRE		RIM	
FRT. _____ LB _____ KG	_____ TIRE _____ RIM		_____ PSI _____ K Pa SING
INT. 5 LB _____ KG	6	7	8 PSI _____ K Pa 9
RR _____ LB _____ KG	_____ TIRE _____ RIM		_____ PSI _____ K Pa
THIS VEHICLE CONFORMS TO ALL APPLICABLE FEDERAL MOTOR VEHICLE SAFETY STANDARDS IN EFFECT ON THE DATE OF MANUFACTURE SHOWN ABOVE.			
SERIAL NO. _____ 10		VIN _____ 11	
TYPE _____ 12	MODEL _____ 13	COLOR _____ 14	

Explanation of Data

- Chassis manufacturer.
- Chassis manufacture date.
- Month and year of manufacture at Winnebago Industries.
- Gross Vehicle Weight Rating: Total permissible weight of the vehicle, including driver, passengers, total cargo carried (including all liquids) and equipped with all options.
- Gross Axle Weight Rating: Total permissible weight allowed for the front, intermediate* and rear axles (listed in pounds and kilograms).
- Suitable Tire Choice: Tires recommended to meet handling and safety requirements. When replacing any of the tires on your vehicle, always replace with a tire that meets these specifications.
- Suitable Rim Choice: Wheel rims recommended to meet handling and safety requirements. When replacing any of the tires on your vehicle, always replace with a tire that meets these specifications.
- Cold Inflation Pressure: Inflation pressures recommended (while cold) for the tires originally equipped on your vehicle. These pressure levels must be maintained to assure proper handling, safety and fuel economy.
- Intermediate* and Rear Axle Wheel Configuration: Single or Dual.
- Serial Number: This is the serial number assigned to the completed vehicle by Winnebago Industries.
- Vehicle Identification Number (VIN): This number identifies the chassis on which the motor home is built.
- Type: States the NHTSA designated usage classification for your motor home. MPV signifies a Multipurpose Passenger Vehicle.
- Model: Lists the Winnebago Industries product model number of your vehicle.
- Color: Signifies the color code number of the decor used throughout the vehicle. This number is necessary for ordering replacement cushions, curtains, carpet, etc.

*Intermediate (INT) data applies only to Class-A models equipped with tag axle.

EXTERIOR FEATURE IDENTIFICATION

Vehicle shown for illustration purposes only.

Actual locations of features depends on model and option combinations.

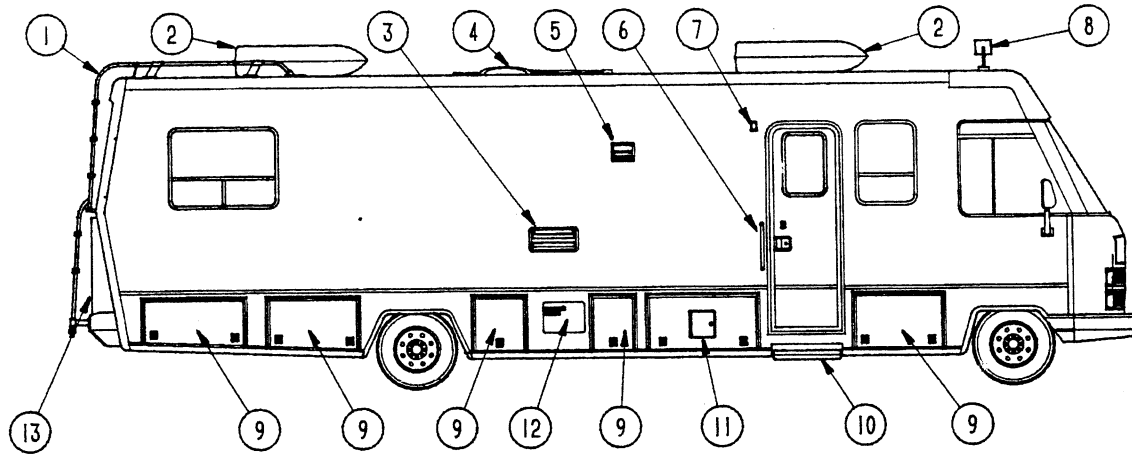

- 1. Luggage Rack and Ladder
- 2. Roof Air Conditioner*
- 3. Refrigerator Access
- 4. TV Antenna*
- 5. Range Hood Vent
- 6. Assist Handle
- 7. Porch Light
- 8. Remote Spot/Flood Light*
- 9. Storage Compartment

- 10. Entrance Step
- 11. LP Gas Tank Compartment
- 12. Water Heater Access
- 13. Spare Tire Compartment
- 14. Air Horns*
- 15. Water System Compartment*
- 16. Fuel Fill
- 17. Sewage Drain/Shoreline Compartment***
- 18. Auxiliary Generator Compartment*

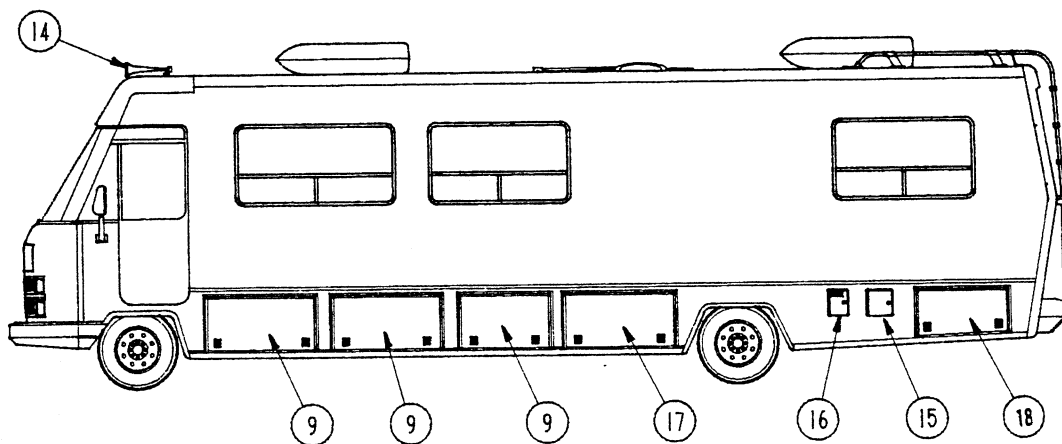

*Optional equipment
 ** Also contains cable TV hook-up

SECTION 1

SAFETY PRECAUTIONS

Read and understand all instructions and precautions in this manual before operating your new motor home. The symbol **WARNING** is used throughout the manual to alert you to precautions that involve your personal safety. Read and follow them carefully. Listed are some safety precautions that must be adhered to. These precautions as well as others that involve damage to equipment are also listed in the appropriate areas in this manual.

General Warnings

- Only seats equipped with seat belts are to be occupied while the vehicle is in motion.
- Make sure all passengers have seat belts fastened in a low and snug position so the force exerted by the belt in a collision will be spread across the strong hip area.
- Never allow passengers to stand or kneel on seats while the vehicle is in motion.
- Sleeping facilities are not to be utilized while vehicle is in motion.
- Examine the escape window and be familiar with its operation, but do not use except in an emergency.
- The fire extinguisher should be inspected monthly for proper charge and operating condition. This should also be done before beginning a vacation or any extended trip.

Driving

- Do not attempt to adjust the driver's seat while the vehicle is in motion.
- Do not adjust tilt steering in a moving vehicle.
- Do not operate the cruise control on icy or extremely wet roads, winding roads, in heavy traffic or in any other traffic situation where a constant speed cannot be maintained.
- Use care when accelerating or downshifting on a slippery surface. Abrupt speed changes can cause skidding and loss of control.
- Driving through water deep enough to wet the brakes may affect stopping distance or cause the vehicle to pull to one side. Check brake operation in a safe area to be sure they have

not been affected. Never operate any vehicle if a difference in braking efficiency is noticeable.

- Adverse weather conditions and extremes in terrain may affect handling and/or performance of your vehicle. Refer to your chassis manual for related information.

Fuel & LP Gas

- All pilot lights must be extinguished and appliances turned off while refilling the fuel tank or LP tank.
- Never smoke while refilling vehicle fuel tank or LP gas tank.
- Avoid inhaling exhaust gases produced by burned gasoline, diesel fuel or LP gas in items such as the range, chassis engine, generator engine, refrigerator, furnace and water heater. They contain carbon monoxide, which by itself is an odorless, colorless and poisonous gas.
- Do not bring or store LP gas containers, gasoline or other flammable liquids inside the vehicle because a fire or explosion may result. LP gas containers are equipped with safety valves which relieve excessive pressure by discharging gas to the atmosphere.
- Do not alter the LP gas system at any time or in any way.
- Do not fill LP gas container(s) above 80 percent of capacity. Overfilling the LP gas container can result in uncontrolled gas flow which can cause fire or explosion. A properly filled container will contain approximately 80 percent of its volume as liquid LP gas.
- Never use an open flame to test for LP gas leaks. Replace all protective covers and caps on LP system after filling. Make sure valve is closed and door latched securely.
- Never connect natural gas to the LP gas system.
- When lighting range burners do not turn burner controls to "On" and allow gas to escape before lighting match.
- Portable fuel-burning equipment, including wood and charcoal grills and stoves, shall not be used inside the recreational vehicle. The use

of this equipment inside the recreational vehicle may cause fires or asphyxiation.

- LP gas regulators must always be installed with the diaphragm vent facing downward. Regulators are equipped with a protective cover. Make sure that the regulator vent faces downward and that the cover is kept in place to minimize vent blockage which could result in excessive gas pressure causing fire or explosion.
- The following warning label has been located in the cooking area to remind you to provide an adequate supply of fresh air for combustion.

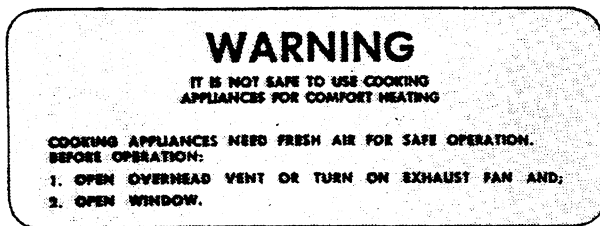

Unlike homes, the oxygen supply inside a recreational vehicle is limited due to its size. To avoid danger of asphyxiation, provide proper ventilation when using the gas rangetop or gas oven. It is especially important that the gas oven and range top not be used for comfort heating. Danger of asphyxiation is greater when these appliances are used for long periods of time.

LP GAS LEAKS

The following label has been placed in the vehicle near the range area. If you smell gas within the vehicle, quickly and carefully perform the procedures listed.

IF YOU SMELL GAS	
1.	Extinguish any open flames, pilot lights and all smoking materials.
2.	Do not touch electrical switches.
3.	Shut off the gas supply at the tank valve(s) or gas supply connection.
4.	Open doors and other ventilating openings.
5.	Leave the area until odor clears.
6.	Have the gas system checked and leakage source corrected before using again.

LP Leak Gauge

Your coach is equipped with a pressure-drop indicator gauge (manometer) to test for LP gas line leaks. This gauge is located in the refrigerator access compartment on the exterior of the coach. It is easily accessible when required.

A leak test should be performed before using the LP system in the following situations:

- after storage periods.
- each time after opening the main supply valve.
- after each LP tank fill.
- daily during periods of extended use.

Read the following operating instructions and additional information in your Motor Home Operation Manual binder before conducting the LP gas leak test.

IMPORTANT

This device does not prevent leaks. It detects and indicates leakage only while operated and observed.

If the gauge indicates a leak, recheck to be sure all appliance gas valves have been shut off.

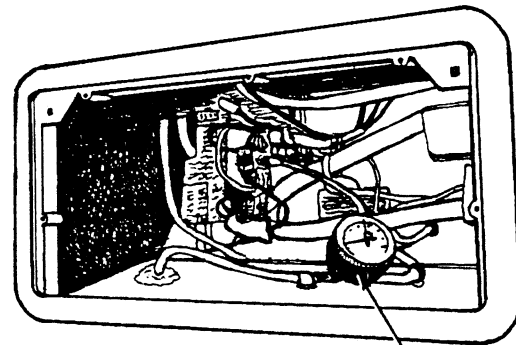

Leak Gauge

(Located in Refrigerator Compartment)

WARNING

Do not smoke or expose the unit to open flame or extreme heat when conducting an LP gas leak test. Never use an open flame to test for gas leaks.

Instructions:

1. Close LP gas tank or cylinder valve(s).
2. Ventilate vehicle. Open doors and windows.
3. Shut off LP gas appliances, including pilots.
4. Now, slowly open LP gas tank or cylinder valve(s).
5. Move the adjustable red needle (B) on the leak gauge to the same position as the black needle (A). The black needle indicates the

line pressure. The red needle is simply a marker.

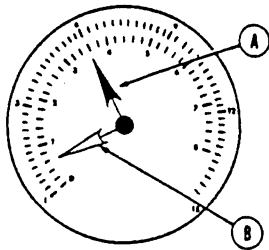

6. Close tank supply valve and monitor the position of the black needle for 5 minutes. If the black needle:
 - A. Stays aligned with the red needle, the system is leak-free at this time. Skip #7 & #8 -- test is complete.
 - B. Drops to a lower position than the red needle, the system has a leak. Go on to step 7.
7. Brush a soapy water solution onto all joints and watch for leaks indicated by bubbles. Tighten joints if necessary and retest.

WARNING

Never use an open flame to test for gas leaks.

Check for leaks with the leak gauge each time the gas valve at the tank is opened, and each day during periods of prolonged use. When testing for gas line leaks with a soapy water solution, DO NOT use a detergent containing ammonia or chlorine. These substances may generate a chemical reaction causing corrosion to gas lines resulting in dangerous leak conditions.

9. If test still shows a leak, contact your Itasca dealer.

Electrical

- Careless handling of electrical components can be fatal. Never touch or use electrical components or appliances while feet are bare, while hands are wet, or while standing in water or on wet ground.
- Improper grounding of the vehicle can cause personal injury. Do not plug the utility power cord into an outlet which is not grounded and do not adapt the plug to connect to a receptacle for which it is not designed.

- Do not attach an extension cord to the utility power cord.
- Be sure that all electrical appliances to be used contain 3-prong plugs for proper grounding.
- Avoid overloading electrical circuits. Replace fuses or circuit breakers with those of the same size and amperage rating only. Never use a higher rated fuse or breaker.
- Use caution when handling or working near electrical storage batteries. Always remove jewelry and wear protective clothing and eye covering. Avoid creating sparks.

Loading

- Store or secure all loose items inside the motor home before traveling.
- Be aware of GVWR, GAWR and individual load limit on each tire or set of duals. (See "Loading the Motor Home" in Section 4.)
- Never load the motor home in excess of the gross vehicle weight rating or the gross axle weight rating for either axle.

Maintenance

- Do not remove the radiator cap while engine and radiator are still hot. Always check coolant level visually at the see-through coolant reservoir.
- Never get beneath a vehicle that is held up by a jack only.
- Do not mix different construction types of tires on the vehicle such as radial, bias or belted tires, as vehicle handling may be affected. Replace tires with exact size, type and load range.
- Do not attempt to start the vehicle by hot wiring.

FORMALDEHYDE INFORMATION**WARNING**

Some components in this vehicle contain formaldehyde based adhesives which may release formaldehyde fumes into the air for an unknown period of time until total dissipation occurs. Individuals who are allergic to formaldehyde gas fumes may experience irritation to eyes, ears, nose and throat. Reaction in infants may be more severe. Although long range effects are not well understood, testing to date has not revealed any serious health effects in humans at the level of emission from these products.

IMPORTANT

To aid in dissipation, ventilate the vehicle by opening all windows and circulating the air with a fan.

CARBON MONOXIDE WARNING**WARNING**

Avoid inhaling exhaust gases, as they contain carbon monoxide, which is a colorless, odorless and poisonous gas.

If you suspect that exhaust fumes are entering the passenger compartment, have the cause determined and corrected as soon as possible. If you must drive under these conditions, drive only with ALL WINDOWS FULLY OPENED.

The best protection against carbon monoxide entry into the vehicle body is a properly maintained engine exhaust and ventilation system. It is recommended that the exhaust system and body be inspected by a qualified motor home service center.

- Each time the vehicle is raised for an oil change.
- Whenever a change in the sound of the exhaust system is noticed.
- Whenever the exhaust system, underbody or rear of the vehicle is damaged.

To allow proper operation of the vehicle's ventilation system, keep front ventilation inlet grill clear of snow, leaves or other obstructions at all times. **DO NOT OCCUPY A PARKED VEHICLE WITH ENGINE RUNNING FOR AN EXTENDED PERIOD.**

Do not run engine in confined areas, such as a garage, except to move vehicle in or out of area. When vehicle is stopped in an UNCONFINED area with the engine running for any more than a short period, adjust heating or cooling system to force outside air into the vehicle as follows:

1. Set fan to medium or high speed and vent control to "air".
2. On vehicles equipped with air conditioning, set fan to medium or high speed and set control to obtain maximum vent air.

Doors and rear windows should be closed while driving to avoid drawing dangerous exhaust gases into the vehicle.

EMERGENCY EXITS**Emergency Exit Window**

Your motor home is equipped with an emergency exit window in the rear or side of the vehicle which functions as an escape exit in an emergency situation.

In one type, the glass is installed with a rubber extrusion. It is opened by pulling on the red plastic loop located at the bottom of the window, until the rubber cord is completely removed. This allows the window to be pushed out.

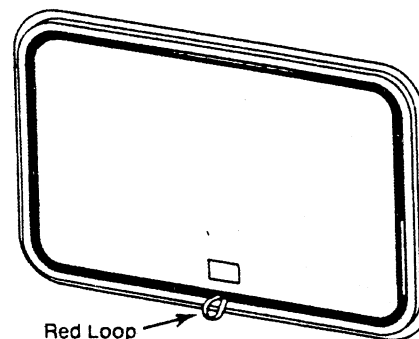

Models 28RQ, 31RQ & 34RA

WARNING

Use emergency window for emergency exit only. Do not test for proper operation.

If the cord is released by accident, but the glass remains in place, the cord can be replaced using a blunt instrument, preferably one made of plastic. We suggest you contact your dealer for assistance.

WARNING

Use care when exiting emergency window, as broken glass may be present in the exit area.

The other type of escape window is secured by two red safety latches and can be opened by first releasing these two latches and then pushing outward on the lower part of the window. Identify which type of emergency exit window is in your vehicle. Instructions for removal are also located on a label on the glass for quick reference and for passengers who may not be familiar with the exit. Be sure this label is never removed or destroyed.

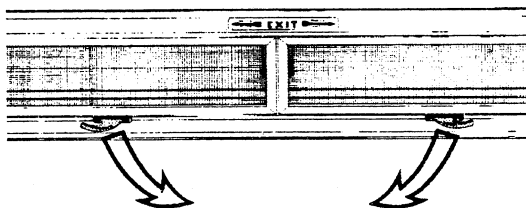

Model 40DA only

Using Slider Windows as Emergency Exits

Most single and double slider windows along the side of the motor home can also be used as emergency exits, should the need arise. To use the windows as exits, slide the window open, then strike the screen near one corner to loosen it and push out.

SAFETY DEVICES

Fire Extinguisher

A dry chemical fire extinguisher is located near the floor by the side entrance door.

We recommend that you become thoroughly familiar with the operating instructions displayed on the side of the fire extinguisher or in the information supplied in your Motor Home Operations Manual binder.

We also recommend that you inspect the fire extinguisher for proper charge at least once a month in accordance with National Fire Protection Association (NFPA) recommendations as stated on the label.

To test for proper charge, push in on the small green peg on the side of the fire extinguisher head. If you feel a resistance and the peg immediately pushes back out, the charge is good. If the peg stays in, the charge is insufficient and the fire extinguisher must be replaced.

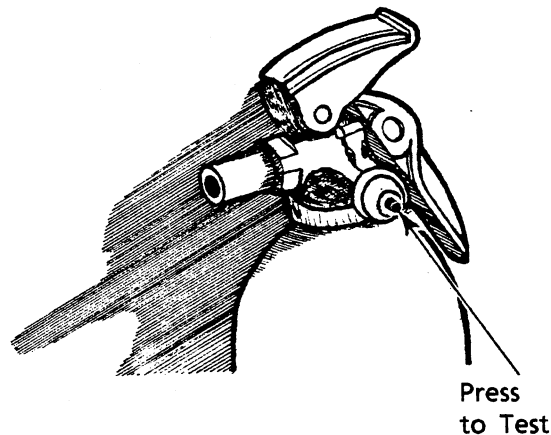

SMOKE ALARM

Your motor home is equipped with a smoke alarm located on the ceiling in the galley area. This alarm meets U.L. Standard 217 and NFPA Standard 74 for operation of smoke detection devices.

1. The smoke alarm should be tested for correct operation each time the vehicle is brought out of storage, before each trip, and at least once a week during motor home use. To test the electronics, firmly depress the button. To test that smoke reaches the sensor, blow smoke in a careful, fire-safe manner into your smoke alarm.

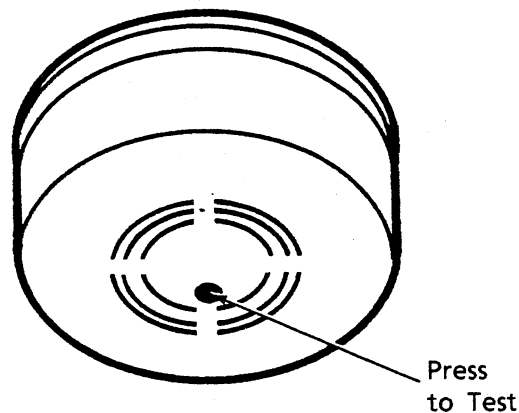

2. Your smoke alarm will not work without power. Never remove the battery to quiet the alarm. When your smoke alarm "beeps" about once a minute the battery is weak. Immediately install a new battery. Be sure to use only batteries specified in manual or on unit. Test unit after installing a new battery.
3. Clean and vacuum the openings on your smoke alarm once a month.

4. Do not open the smoke alarm or try to repair it. For replacement information see warranty in Owner's Manual.
5. Smoke alarms have technical limitations and may not respond in all situations. FIRE PREVENTION is your best safeguard.

See your motor home Operation Manual binder for further information.

SECTION 2 DRIVING YOUR MOTOR HOME

(See also Safety Precautions, Section 1 of this manual.)

IMPORTANT

This section describes only those instruments and controls which are unique to Itasca motor homes. For complete information regarding all other equipment, controls and instructions, consult the chassis manual or the equipment manufacturer's information provided in your Motor Home Operation Manual. In addition, some items described may be optional or unavailable on your vehicle.

BEFORE ENTERING YOUR VEHICLE

Before entering your vehicle, there are a few recommended procedures that will aid in your driving safety and equipment.

1. Be sure that the windows, mirrors and light lenses are clean and unobstructed.
2. Make sure all exterior lights operate properly.
3. Check tires for proper cold inflation pressures.
4. Check wheel lug nuts for tightness.
5. Look beneath the vehicle for noticeable fluid leakage.
6. Check fluid levels and fill if necessary. This includes engine oil, transmission fluid, coolant, brake fluid, power steering fluid and windshield washer solvent.

WARNING

The transmission must be in P (Park) and park brake engaged while performing any checks or adjustments.

The engine should be shut off unless specifically required for a certain procedure.

7. Unhook and store sewer and water supply hoses.
8. Retract step.
9. Be sure that all of your cargo is secured in event of a sudden stop or an accident.
10. Check around your vehicle in all directions to assure that you have proper clearance.
11. Lower TV antenna.
12. Disconnect and store shoreline.

WARNING

Before driving your vehicle, be sure you have read the entire operator's manual and that you understand your vehicle's equipment completely and how to use the equipment safely.

BEFORE DRIVING YOUR VEHICLE

Before preparing to drive your vehicle, here are a few recommended procedures that will add to your driving safety and enjoyment.

1. Be sure that you adjust the interior and exterior rear view mirrors to your driving preference.
2. Adjust the driver's seat for proper distance from foot pedals and steering wheel to allow for safety and ease in controlling your vehicle.
3. Place front seats in the forward facing position.
4. Be sure to fasten all safety belts to fit you comfortably, but tight enough to obtain the full safety of the belts.
5. Make sure all doors are completely shut and locked. When the doors are shut and locked, there is less chance of the doors flying open in event of an accident. It also prevents unintentional opening of doors and keeps intruders out of your vehicle.
6. Check to see that all gauges are operating properly.
7. Check the fuel level in the vehicle.
8. Be certain that the fire extinguisher is fully charged and secure in its mounting bracket.

CAUTION

Be sure hood and all compartment doors are latched securely before driving vehicle.

KEYS

Your motor home is supplied with several sets of keys. In addition to the chassis manufacturer's ignition key, you receive keys for front doors and entrance door, exterior compartment doors and fuel fill.

Each set of keys has an identification number, either on a small metal tag or on a knock-out plug in the key head. Record these numbers and keep them in a safe place. In case keys are lost or stolen, your dealer or a locksmith can provide you with duplicate keys or modify the locks.

FUEL SELECTION

Refer to your chassis operating guide for the manufacturer's recommendations on proper fuel selection.

WARNING

Modern fuel systems may build up pressure within the tank as the gasoline warms during use or in hot weather.

Under certain conditions, sudden release of this pressure when removing the gasoline cap can spray gasoline from the fuel fill opening, causing a possible hazard.

GASOLINE FUEL FILL

Removing the Fuel Cap

When removing the gasoline cap, slowly rotate it **only far enough to allow pressure to release**. After any "hissing" sounds stop, continue removing the cap.

Filling the Tank

Do not overfill the fuel tank. Allow gasoline to pump into the tank until the auto-shutoff valve in the fuel pump nozzle stops the flow of fuel, indicating a full tank. This provides a pre-determined vapor space at the top of the tank to allow for expansion of the gasoline.

CAUTION

Continuing to fill above this level may cause damage to the fuel/evaporative emissions system.

Fuel Tank Capacity:

28' Chevy	60 gal.
32' - 34' Chevy	78 gal.
All Ford	75 gal.
Oshkosh	90 gal.

Replacement Fuel Caps

To protect gasoline system from excessive pressure or vacuum, or from sudden pressure, replace lost caps with caps of the same design available from your dealer.

STARTING AND STOPPING ENGINE

Refer to your chassis operating guide for the manufacturer's recommendations on starting and stopping the engine.

Parking the Vehicle

To park the vehicle, apply the foot brake then move the transmission selector lever to **P**. The transmission will then be out of gear and the drive wheels will be mechanically locked.

If the transmission is shifted into **N**, the drive wheels will not be locked and the vehicle may roll unless the park brake has been applied.

Parking on a Hill

Always set the parking brake **before** shifting the transmission into Park* while on an incline to prevent the weight of the vehicle from resting on the park pawl inside the transmission. If this is not done, a condition called "torque lock" can result, making it extremely difficult to shift the transmission out of Park.

Before moving the vehicle, shift the transmission out of Park before releasing the park brake in order to avoid the same problem.

If "torque lock" does happen, you may need to have another vehicle nudge this vehicle uphill to take pressure off the transmission while you pull the transmission selector out of Park.

*This precaution is not possible (or necessary) on vehicles with the automatic park brake feature.

PARKING BRAKE

Never drive your vehicle with the parking brake set as this will reduce parking brake effectiveness and cause excessive wear. See your chassis operating guide for parking brake operating instructions.

HAZARD WARNING LIGHTS

See chassis manual or "Instrument Panels" in this section for location of hazard flasher switch. See also Section 3 for further operating information.

FUEL PUMP SHUT-OFF SWITCH (Ford and Oshkosh Chassis Only)

Vehicles built on Ford and Oshkosh chassis are equipped with an inertial type switch that shuts off the fuel pump in the event of collision. This switch must be manually reset to resume the fuel supply to the engine.

See your chassis operating guide for location and reset procedures for this switch.

IMPORTANT

It is possible to accidentally trigger this switch by abruptly striking an object such as a curb or parking block. If your vehicle exhibits symptoms of running out of fuel immediately after such an occurrence, the fuel pump shut-off switch may need to be reset.

Consult your chassis operating guide for additional information.

DOOR LOCKS AND HANDLES

Cab Doors:

To lock and unlock the cab doors from the outside of the vehicle, insert the key into the lock and turn.

To open the doors from the inside of the vehicle, pull the latch lever outward. The doors are locked from the inside of the vehicle using the lock slide switch. Deadbolts are also provided for extra security.

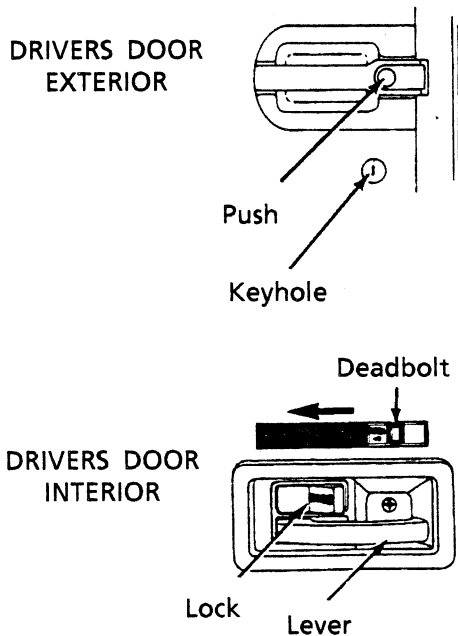

Entrance Door:

The entrance door may be opened from outside the vehicle by pulling the door handle outward. To open the door from inside, pull upward on the door handle. When the door is locked, neither the inside nor the outside door handle can be operated. It can be locked and unlocked from the outside of the vehicle by inserting the key into the lock and turning.

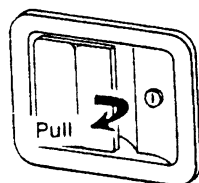

To lock the door from inside, slide the lock button to the right. The deadbolt lock is for added security and should be used as security night locks.

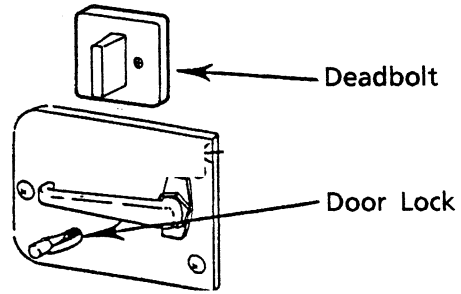

Lubricate the locks periodically with graphite to maintain good working condition.

CAUTION
Instruct all passengers in operation of this door catch system as well as emergency exit window.
Never force the inside door handle downward, as damage could occur.

IMPORTANT

Keys should always be removed when leaving the vehicle. Since doors can be locked without keys, make sure they have been removed from the ignition before locking the driver's compartment.

ENTRANCE STEP - Manual

To extend the entrance step, lift up on the front of the step and pull out until it drops into position. To retract, lift up on front of step and push back until step locks into travel position.

ENTRANCE STEP - Powered

The electric entrance step will extend automatically when you open the entrance door, and retract when you close the door. You can also switch the step power off if you want to keep the step extended while parked at a campsite, when you exit and enter the coach frequently. This saves wear on the step mechanism and conserves coach battery power.

The step power switch is located on the cabinet to the left of the doorway as you enter the coach. If you turn the switch off while the step is extended, it will remain extended until you turn the switch back on. Also, if you turn the switch off while the step is retracted it will not extend when the door is opened until you turn the switch back on.

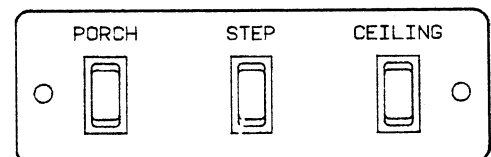

Step Power Switch

If the step will not extend or retract, check the step power switch or the auxiliary battery switch on the dash. The step is powered by the coach battery, so the auxiliary battery switch must be ON for the step to operate. If a problem persists, see your authorized dealer for service.

The step will automatically retract if the entrance door is closed and the vehicle engine is started. The special feature prevents damage to the step from driving off with the step extended.

See the power step owner's manual in your Motor Home Operations Manual for operating instructions and additional information.

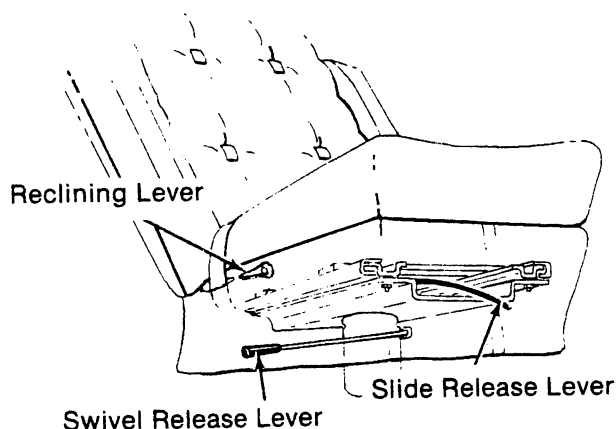

WARNING

Do not use steps unless they are fully extended.

CAUTION

Always remember to retract the entrance steps before traveling or moving the vehicle.

The steps will remain extended, and can be damaged, if the auxiliary battery disconnect switch is not connected before leaving a site after the steps have been locked in the extended position. The Auxiliary Battery Disconnect Switch should only be turned off (disconnected) when storing your vehicle.

WARNING

Do not adjust driver's seat while vehicle is in motion.

After adjusting seat, always use body pressure to make sure slide and swivel locking mechanisms have engaged.

Arm Rest Adjustment

The seat assembly arm rest may be adjusted to alter the angle at which the arm rest will remain when placed in the lowered position. To reposition the arm rest angle, proceed as follows:

Position 1 - Raise armrest, push in toward seat body and lower into position.

Position 2 - Raise armrest, pull outward from seat body and lower into position.

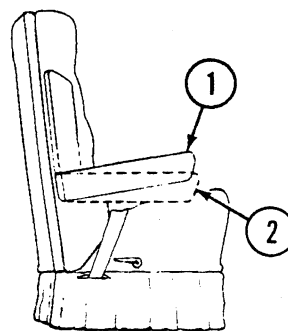

SEATS

The driver and co-pilot seats may be independently adjusted to suit individual preference. To move the set forward or backward, move the slide release lever, located under the front of the seat, to the left and exert slight body pressure in the direction desired.

The seats may be swiveled to provide easy entrance and exit. The swivel feature also allows the seats on some models to be turned toward the living area for additional seating while the unit is parked. To swivel the seats, press the release lever, located on the right side of the seat, to the rear and rotate seat. The seats are designed to lock only when returned to the forward facing position.

To recline the seats, depress reclining lever, lean back to desired incline and release the lever. To return to the upright position, depress the lever and lean body forward. Allow the seat to return to the desired position and release the lever.

Optional 6-Way Power Seat Control

The driver seat is adjusted using the switch panel shown, located on the left-hand side of the seat. Switch 1 controls seat front elevation and switch 3 controls the seat rear elevation. The fore-aft positioning of the seat is controlled by switch 2.

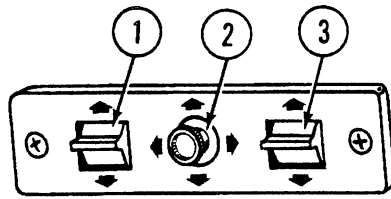

Power Seat Control

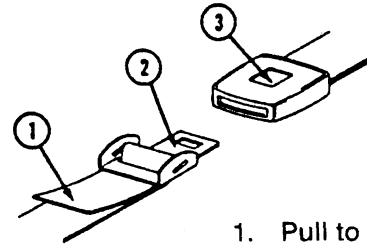

1. Pull to tighten.
2. Tongue.
3. Push to release.

LOUNGE CHAIRS

Some vehicles are equipped with lounge chairs which swivel.

These chairs features a side-facing swivel lock for your safety while the vehicle is moving.

To Lock: The lock handle is located below the right side of the seat, behind the skirt.

1. Turn handle so that it points either upward or downward.
2. Swivel chair to aisle-facing position.
3. When you hear a "click," seat is locked into position.

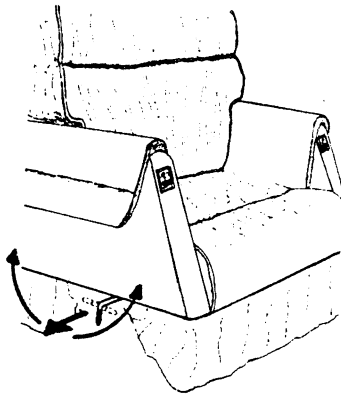

To Unlock: Pull the handle outward (away from the seat base) and turn it to a horizontal position. The seat can now swivel freely.

SEAT BELTS

Seats intended for occupancy while the vehicle is in motion are equipped with seat belts for the protection of the driver and passengers. The lap belts must be worn as low as possible and fit snugly across the hip area. Always sit erect and well back into the seat. To implement full protection of the safety belt, never allow more than one occupant to use the same safety belt at any one time, and do not let the safety belts become damaged by pinching them in the doors or in the seat mechanism. After any serious accident, any safety belts which were in use at the time should be replaced.

Adjustment: To lengthen belt, turn tongue at a right angle to belt and pull to desired length. To shorten, pull loose end of belt.

To Fasten: Be sure belt is not twisted. Grasp each part of the belt assembly and push tongue into buckle. Adjust to a snug fit by pulling the loose end away from the tongue.

To Release: Depress button in center of buckle and slide tongue out of buckle.

WARNING

Snug and low belt positions are essential. This will ensure that the force exerted by the lap belt in a collision is spread over the strong hip area and not across the abdomen, which could result in serious injury.

Only seats equipped with seat belts are to be occupied while vehicle is in motion.

Lap-Shoulder Belt

Fastening: Hold the belt just behind the tongue using the hand nearest to the door. Next, bring the belt across the body and slide the tongue into the buckle until the latch engages.

Unfastening: Press the release button in the buckle. Hold onto the tongue when you release it from the buckle to keep it from retracting too rapidly.

When the lap-shoulder belt is in use, the lap portion must ride across the strong hip area and the shoulder portion must ride diagonally over the shoulder blade toward the buckle.

The shoulder belt is designed to lock only during a sudden stop, sudden body movement or a collision. At all other times it will move freely with the occupant.

WARNING

Never wear the shoulder belt in any position other than as stated above. Failure to do so could increase the chance or extent of injury in a collision.

CHILD RESTRAINTS

All 50 of the United States and the District of Columbia now require the use of the child/infant restraint systems for children in vehicles.

A properly installed and secured child restraint system can help reduce the chance or severity of personal injury to a child in an accident or during a sudden maneuver. Children may be injured in an accident if they are not seated in a child restraint which is not properly secured.

A child restraint system is designed to be secured in a vehicle seat by a lap belt or the lap belt portion of a lap-shoulder belt. According to accident statistics, children are also safer when properly restrained in rear seating positions than in front seating positions.

When purchasing a child restraint system:

1. Look for the label certifying that it meets all applicable U.S. Federal Motor Vehicle Safety Standards (FMVSS) or, in Canada, requirements of the Children's Car Seats and Harnesses Regulations (CCSHR).
2. Make sure that it will attach to your vehicle and restrain your child securely and conveniently so that you are able to install it correctly each time it is used.
3. Be certain that it is appropriate for the child's height, weight and development. The instructions and/or the regulation label attached to the restraint typically provides this information.
4. Review the instructions for installation and use of the restraint. Be sure that you understand them fully and can install the restraint properly and safely in your vehicle.

OUTSIDE MIRRORS

Always adjust mirrors for maximum rear visibility before driving off. Make sure the seat is adjusted for proper vehicle control and that you are sitting back squarely into the seat.

Standard Mirrors

Tilt the surface of the mirror gently up or down; left or right, to obtain the best rear view.

Power Electric Mirrors - Optional

The electric mirrors are adjusted using a multi-directional switch located on the driver's door or the driver's side panel.

Select the mirror to be adjusted by pushing the switch in the middle of the control to the right or left. Then press the arrow buttons as necessary to obtain the best view.

When mirrors are adjusted to preference, place the selector switch back in the middle position to cancel power to the buttons. This prevents accidental misadjustment of mirror settings.

The mirrors also contain heating elements to defog or de-ice the mirror glass during cold weather operation. An ON-OFF switch for the mirror heaters is located near the remote mirror controls.

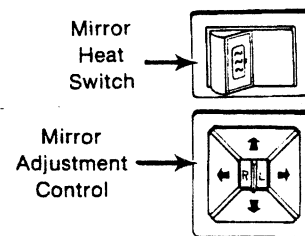

The power mirror control switch is intended for fine adjustment of the mirrors. If you cannot adjust a mirror properly using the control switch, it may need a coarse adjustment.

To do this, loosen the 2 set screws at the ball and socket base of the mirror. Adjust the mirror to the proper viewing angle, then retighten the set screws. Fine adjustment can now be done with the control switch.

SONY REARVIEW TV MONITOR SYSTEM - Optional

If your motor home is equipped with this optional system, refer to the Motor Home Operation Manual binder for specific instructions.

**INSTRUMENT PANEL
(Chevrolet 1990 Chassis)**

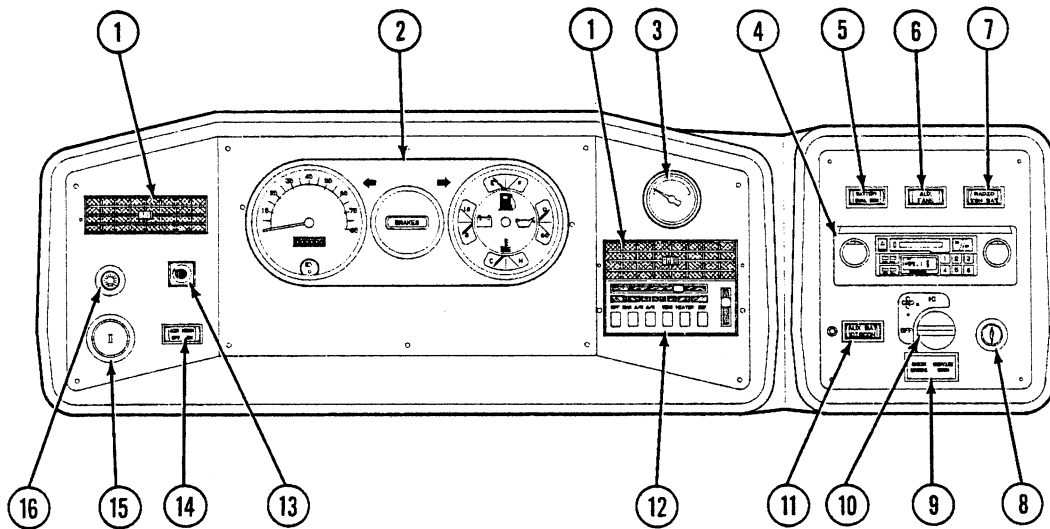

- 1. Vent/Air Conditioning Register
- 2. Instrument Cluster
- 3. Vacuum/Fuel Economy Gauge
- 4. Radio/Cassette Player
- 5. Battery Mode Switch
- 6. Aux. Defrost Fan Switch*
- 7. Radio Power Switch
- 8. Cigarette Lighter

- 9. Check Engine/Service Soon Warning
- 10. Rear Auto Heater Switch
- 11. Aux. Battery Disconnect Switch
- 12. Heater - A/C Controls
- 13. Fog Light Switch
- 14. Air Horn Switch*
- 15. Ignition Switch
- 16. Headlight Switch/Panel Dimmer

**INSTRUMENT PANEL
(Chevrolet 1991 Chassis)**

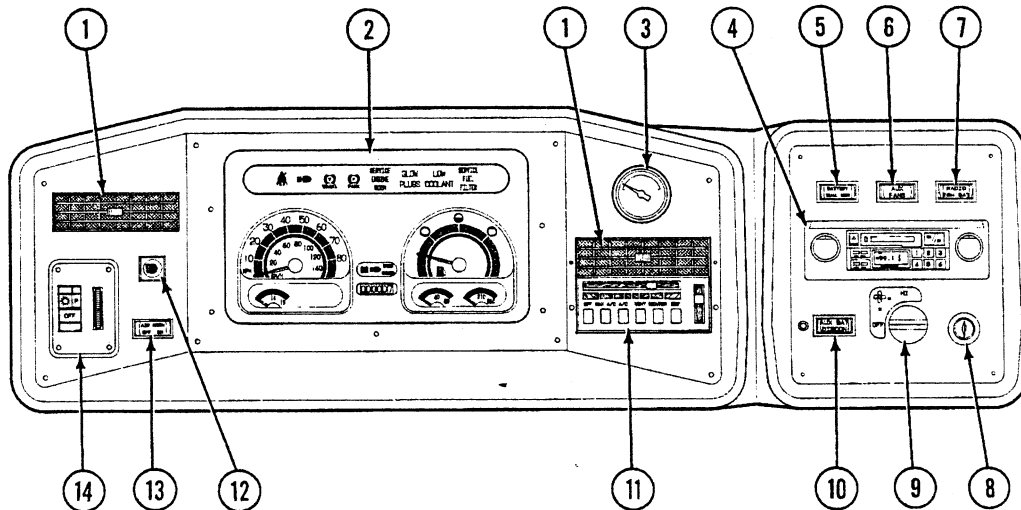

- 1. Vent/Air Conditioning Register
- 2. Instrument Cluster
- 3. Vacuum/Fuel Economy Gauge
- 4. Radio/Cassette Player
- 5. Battery Mode Switch
- 6. Aux. Defrost Fan Switch*
- 7. Radio Power Switch

- 8. Cigarette Lighter
- 9. Rear Auto Heater Switch
- 10. Aux. Battery Disconnect Switch
- 11. Heater - A/C Controls
- 12. Fog Light Switch*
- 13. Air Horn Switch*
- 14. Headlight Switch/Panel Dimmer

INSTRUMENT PANEL (Ford & Oshkosh Chassis)

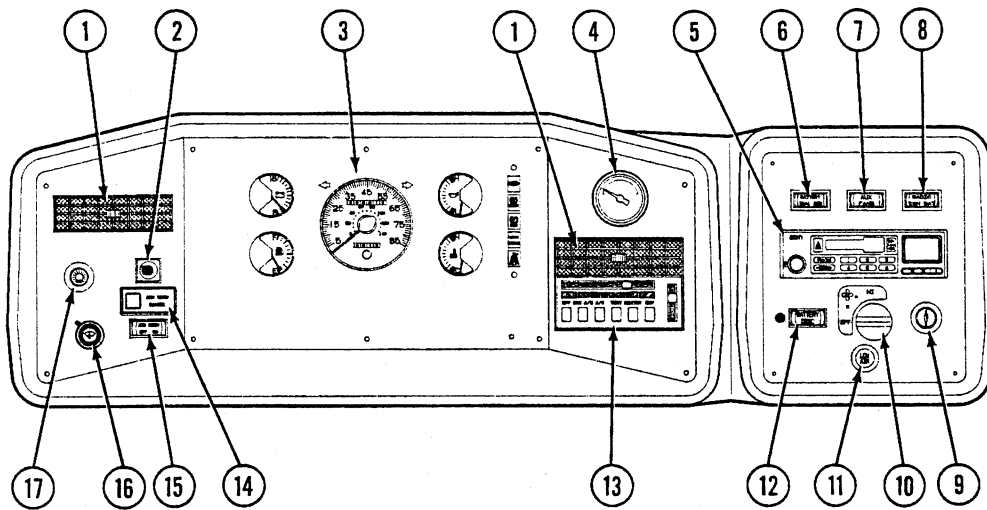

1. Vent/Air Conditioning Register
2. Fog Light Switch*
3. Instrument Cluster
4. Vacuum/Fuel Economy Gauge
5. Radio/Cassette Player
6. Battery Mode Switch
7. Aux. Defrost Fan Switch*
8. Radio Power Switch
9. Cigarette Lighter

10. Rear Auto Heater Switch
11. Tag Axle Low Air Warning#
12. Aux. Battery Disconnect Switch
13. Heater - A/C Controls
14. Overdrive Cancel Switch**
15. Air Horn Switch*
16. Wiper/Washer/Delay Switch
17. Headlight/Panel Dimmer Switch

* Optional

** Ford chassis only

Model 40DA only

MULTI-FUNCTION SIGNAL LEVER (Chevrolet Chassis)

The multi-function signal lever controls the turn signals, high/low beam changing, windshield washer, wipers and wiper delay, and the electronic speed control.

Headlight Beam Change and Turn Signals

Move multi-function lever upward for right turn signal and downward for left turn signal.

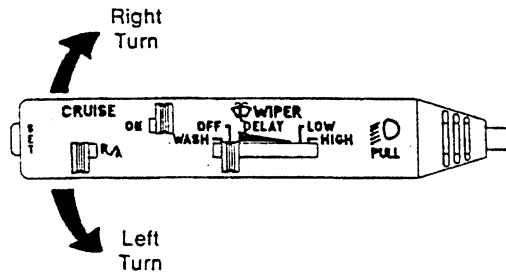

Squeeze and release end of handle to switch high to low beam, or low to high beam.

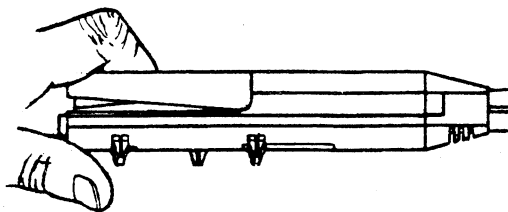

Windshield Wipers and Wiper Delay

Move slide button from OFF to DELAY; you will get a wipe and a delay between wipes (ranging from 45 seconds to 2 seconds) as slide moves to the right.

A continuous LO speed or HI speed wipe can be obtained by moving slide button to position.

Moving slide button to OFF position stops wipers and puts wiper motor in PARK position.

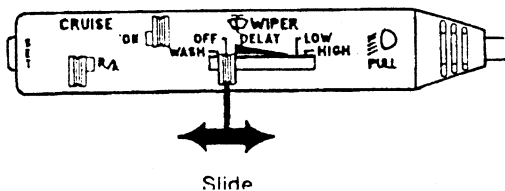

Windshield Washer

Move slide button to WASH position and release; wash solution is delivered with an approximate five second wipe cycle to follow. A (demand) wash and wipe is performed as long as the WASH button is ACTIVATED.

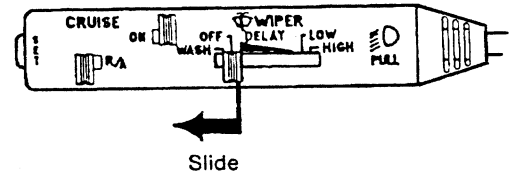

CRUISE CONTROL (Chevrolet Chassis)

In the regulator box of your Cruise Control is a safety switch which will not let the system operate until your vehicle is moving above a preselected low speed. At the factory this "low speed switch" is set to close between 27 and 33 mph.

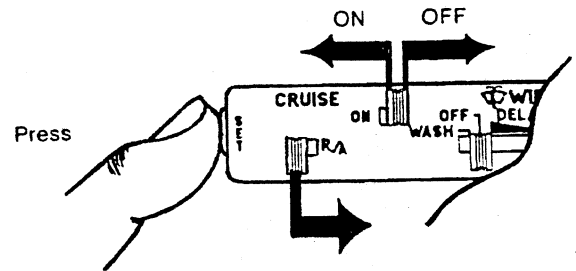

Set Speed - On the control switch, move the slide button to the ON position and drive at any speed above 32 mph at which you want automatic control. Hold that speed with your foot while you press and release the SET/COAST button. One second after release, take your foot off the accelerator pedal.

You can increase speed at any time with the accelerator pedal. When you release the pedal, you will return to the set speed.

Acceleration - Hold the slide button in the RESUME/ACCEL position and your vehicle will accelerate until you release it, then your vehicle will slow to your set speed and again control there.

If you want to make the higher speed your new set speed, release the slide button when you reach the speed you want, and as you do, quickly press and release the SET/COAST button. Remember, you set speed as you release the button - not when you press it.

Coast - When you press and hold the SET/COAST button, you erase the set speed from the regulator's memory and allow the vehicle to coast. Just before you reach the lower speed you want, release the button and it will maintain speed there, provided it is above the low speed setting.

Disengagement - Depress the brake pedal about an inch and you are again in control of the vehicle speed. You can also disengage the speed control by pushing the slide button to OFF, but this erases the set speed from the regulator's memory.

Resume - When you disengage the system with the brake, you do not erase the set speed from the regulator's memory, even if you come to a complete stop. To return to your chosen speed, drive to a speed above 32 mph, then move the slide button to the RESUME/ACCEL position and release it. The speed control will take you back to your set speed and control there.

If the rate of acceleration is faster or slower than you like, drive with the accelerator to a speed close to the set speed, then slide the button to the RESUME/ACCEL position and release it.

Unusual Conditions - When the regulator is adjusted right, your selected speed should be held within plus or minus 4 mph so long as grades do not exceed 7% (most interstate highways). Since the speed control is vacuum operated, this speed range will widen as you drive at higher altitudes.

Any opening of the throttle lowers the vacuum to some degree. A wide open throttle can drop the vacuum almost to zero. When you are pulling an extra heavy load, climbing a very steep hill, or bucking a strong head wind, a much wider than normal throttle opening is needed. But this drops the vacuum too low to let the throttle hold speed.

The way to handle these occasional problems is to bring the vehicle up to speed with the accelerator pedal and then let the speed control take over again.

WARNING

Do not operate the cruise control on icy or extremely wet roads, winding roads, in heavy traffic, or in any other traffic situation where a constant speed cannot be maintained.

There is no drain on the battery when the ignition switch is off - even if the control switch is left on.

NOTE: Before leaving on vacation or a long trip, make a short road test to see that all functions are working. If your speed control does not function as described, contact your Winnebago dealer or refer to the cruise control manufacturer's information in your Motor Home Operations Manual binder.

CRUISE CONTROL

(Ford and Oshkosh Chassis)

Consult your chassis operating guide for operating instructions.

WINDSHIELD WASH/WIPER SWITCH

(Ford and Oshkosh Chassis)

Wash: Press the control knob to pump washer solution onto the windshield. Wiper will also begin operating. The wiper will continue for 5 wipes after you release the washer knob.

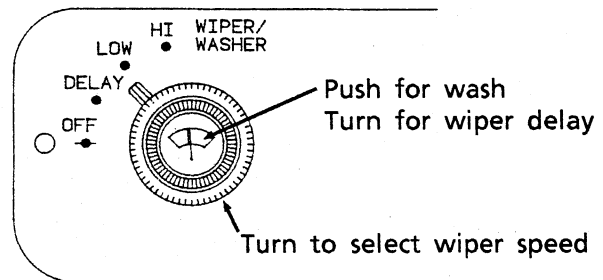

Wipe: Rotate the outer knob pointer to the desired setting - Delay, Low, or Hi.

Delay: Turn the outer knob pointer to "DELAY". Turn the center (wash) knob to set the time you want between wipes, from 1 second (all the way left) to about 90 seconds (all the way right).

COMFORT CONTROLS

AUTO AIR CONDITIONER/HEATER

Controls for the air conditioner, heater, defroster and vent are all combined into one control panel. Refer to the following instructions for use of individual controls.

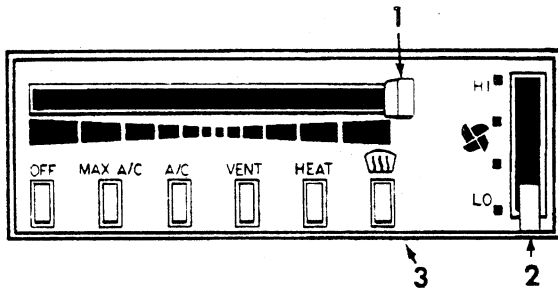

1. Temperature Control Lever
2. Front Heater Fan Switch
3. Mode Selection Buttons

Heating

- A. For maximum heating:
 1. Press the HEAT button.
 2. Move the temperature control lever to WARM (red).
 3. Place the fan switch to HI.
- B. For reduced heating:
 1. Move the temperature control lever to the left to an intermediate setting.
 2. Adjust the fan speed for desired volume.

Defrosting

- A. For maximum defrosting and defogging:
 1. Press the DEF button.
 2. Move the temperature control lever to WARM (red).
 3. Place the fan switch in HI.
- B. For reduced defrosting:
 1. Move the temperature control lever to the left to an intermediate setting.
 2. Adjust the fan speed for desired volume.

Ventilation

- A. To vent outside air into the vehicle when neither heating or cooling is required:
 1. Press the VENT button.
 2. Move the temperature control lever left to COOL (blue).
 3. Adjust the fan speed for desired volume.

Air Conditioning

- A. For maximum cooling:
 1. Press the MAX A/C button.
 2. Move the temperature control lever all the way left to the COOL (Blue) position.
 3. Place the fan speed switch in HI.
- B. For reduced cooling:
 1. Set the fan speed to a lower setting and/or move the temperature control lever toward a warmer setting.

- C. The normal A/C button offers cooled outside air at a slightly reduced capacity.

Off

When no heating, cooling or defrosting are required:

1. Press the OFF button. This will shut off the fan and prevent outside air from entering the unit.

IMPORTANT

The automotive air conditioner is not designed to cool the entire interior of the motor home, but is intended to cool the driver's compartment only.

Rear Auto Heater

To provide auxiliary heat to the rear of the vehicle, turn the rear heater fan switch to the desired speed.

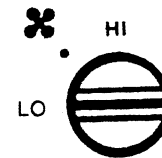

RADIO/CASSETTE PLAYER

Most vehicle models are available with a standard or optional AM/FM radio/cassette player that provides high quality stereo sound for your traveling and living enjoyment. Refer to your Motor Home Operation Manual for operating and care instructions.

CAUTION

If your radio is equipped with an electronic tuning receiver, disconnect the radio power fuse before attaching a battery charger or jumper cables to the battery. The radio tuner may become damaged if this is not done.

RADIO SWITCH

The radio switch allows you to connect the auto radio to the coach batteries for operation while parked, with the ignition switch off. This prevents accidental draining of the automotive (starting) battery by the radio.

VACUUM FUEL ECONOMY GAUGE

This gauge provides a guide to efficient engine operation. It is impossible to specify an ideal gauge reading, as this will vary a great deal according to operating conditions. However, as a general rule, a high reading usually indicates the

most efficient engine operation and the best fuel economy. The vacuum level will be high at idle speed, and as speed and load increase, the vacuum level will drop. To obtain maximum fuel economy, operate the motor home in such a way as to maintain vacuum level as high as possible.

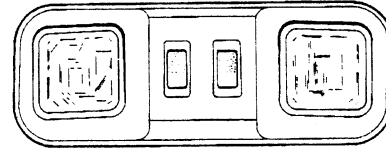

BATTERY MODE SWITCH

The battery mode switch is used to connect the auxiliary batteries to the automotive electrical system, allowing them to be recharged by the engine alternator while driving. The momentary (MOM) position can be used to provide additional starting power from the motor home auxiliary battery if the automotive battery is discharged.

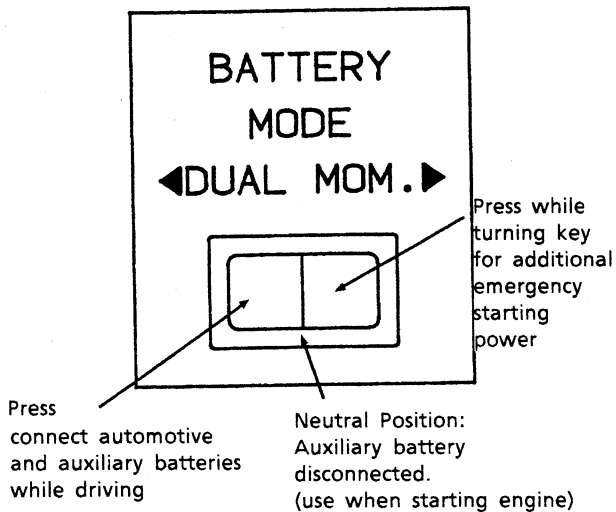

If you wish to control the lights from the dash, leave the individual switches on and use only the dash switch.

AUXILIARY FAN SWITCH

If your vehicle is equipped with auxiliary defrost fans, a switch is located on the instrument panel.

AIR HORNS - Optional

A switch located on the instrument panel activates the optional air horn system. While this switch is on, the air horns are sounded using the steering wheel horn button. When the switch is turned off, only the standard horns will sound.

NOTE: Since air horns are extremely loud, it is recommended that you deactivate them while driving in areas where noise abatement ordinances may be in effect.

A 50-foot air hose is also supplied with the vehicle if equipped with air horns. The hose is stored in a box in the wardrobe cabinet. The hose may be connected to the air horn compressor in the engine compartment and used to inflate beach equipment, air mattresses, tires, etc.

COACH LEVELING SYSTEMS

Coach leveling systems are designed to diminish site selection problems, making "set up" at a camping site faster and more convenient for you.

IMPORTANT

When parking at an uneven site, always park the front of the motor home to the downhill side. This allows you to level by raising the front end rather than the rear. Since only the rear wheels are locked while in PARK, raising the rear wheels off the ground could allow the vehicle to roll off the jacks.

HYDRAULIC LEVELING SYSTEM (HWH®) Optional

The leveling system control panel is located on the floor to the left of the driver's seat. Each of the four leveling units (jacks) is controlled by its own lever.

CAUTION

Damage to the automotive alternator can occur if the 110-volt auxiliary generator is started while both batteries are connected.

AUXILIARY BATTERY DISCONNECT SWITCH

See related item in Electrical section.

MAP LIGHT

The aircraft style map lights are mounted overhead in the driver compartment. Each light may be swiveled to the desired lighting position. Individual switches for each light are located on the base of the light.

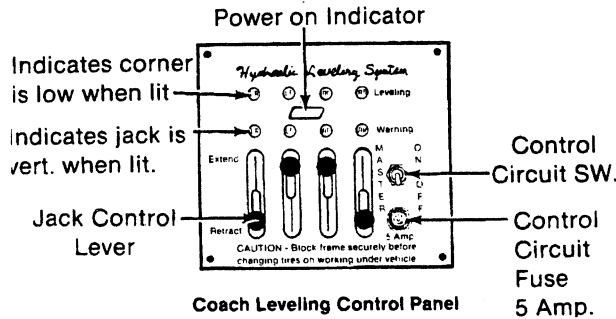

manually adjusted up-and-down or side-to-side to simulate the function of a hydraulic leveling system. This provides the vehicle owner with a reasonable degree of flexibility in parking/camping site selection.

Park & Level™ Controls

The Park & Level control panel is located at the lower left-hand side of the dash. It contains 3 rocker switches, a compressor indicator light, and a manual mode warning light.

To Level the Motor Home:

1. Be sure the vehicle is in PARK and the parking brake is applied.
2. Turn the Master switch ON.
3. Operate the jack levers alternately, beginning with the front leveling units, until all of the lights on the lever control panel are off, indicating that the vehicle is level.
4. Turn the Master switch off.

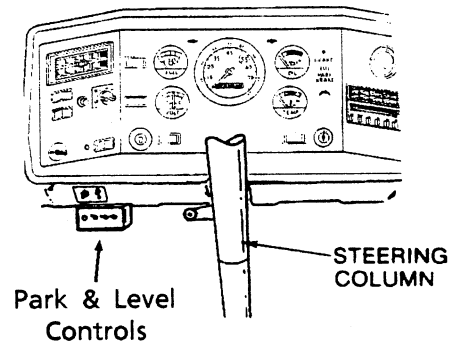

JET AIR RIDE™ SUSPENSION SYSTEM - Optional

OPERATING INSTRUCTIONS

Normal Driving Mode

The mode switch should be placed in the "Auto" position before driving off. A red warning light will alert you when the system is in the Park & Level™ (Manual) mode.

Leveling

Flip the red toggle switch to "Manual." This switch will illuminate to indicate that the leveling feature is activated. Level the vehicle by operating the black switches.

CAUTION
Do not drive the vehicle with the Auto/Manual Mode Switch in the Manual position. Damage to suspension components could result.

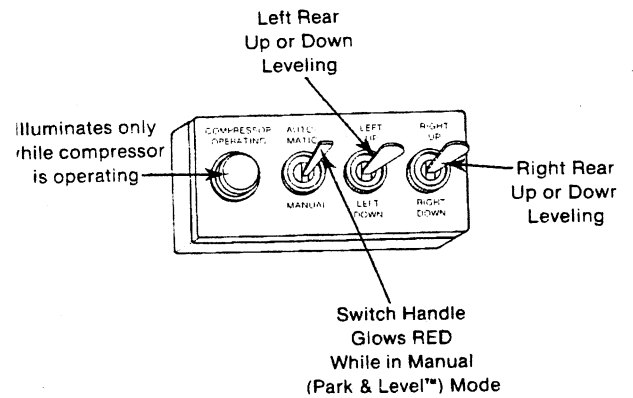

NOTE: Automatic leveling is deactivated when the ignition is switched off. Therefore, it is possible for the vehicle to appear "jacked up" in the rear under certain circumstances.

This is not a malfunction and should be no cause for alarm. When the vehicle is restarted, the automatic leveling system will immediately correct this situation.

Park & Level™ System

The Park & Level system incorporates electronic air distribution controls for vehicle leveling purposes. It allows air spring pressure to be

- When raising the rear of the vehicle, operate both springs at the same time to provide maximum lifting power.
- When parked on a side hill, raise both springs as mentioned above, then lower the spring on the "uphill" side until the vehicle is level.
- When you're ready to drive off, switch the mode to "Automatic." The springs will automatically adjust for road travel.

NOTE: The air bags will inflate and deflate slightly about 5 to 8 times until the coach is leveled.

Compressor Light

The red indicator light labeled "Compressor On" will illuminate only while the compressor is operating. When air pressure depletes to a preset minimum amount, the compressor will operate until maximum pressure is restored.

It is normal for the compressor to operate periodically while driving to maintain air pressure in the system. It will also operate for a few minutes after starting the vehicle and switching the Auto/Manual switch back to "Auto" (when Park & Level™ has been in use) to restore air pressure released during leveling.

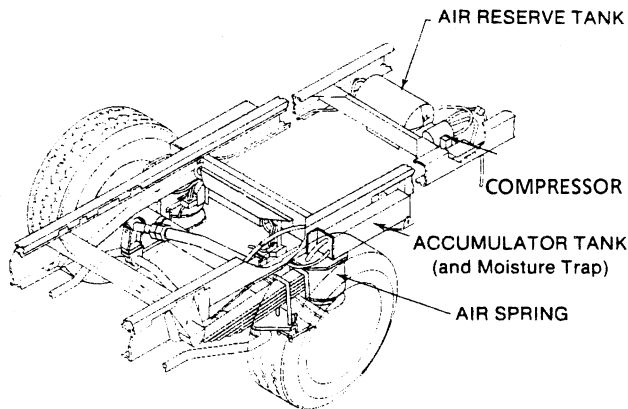

Periodic Maintenance

There are very few items on this suspension system that require periodic maintenance. Here is a simple maintenance suggestion:

- Purge moisture from air reserve and accumulator tanks before freezing temperatures and/or vehicle storage. To do this, briefly turn the drain valve at the bottom of each tank 90° to expel any water. Open the accumulator tank valves for only 1 or 2 seconds at a time because the coach will settle as this is being done. Purging is complete when you see no more water spraying from the drains.
- Periodically inspect air hoses for abrasions or other conditions which result in air leaks.

MANUAL COACH STABILIZERS - Optional (w/o Leveling System)

Coaches not equipped with HWH hydraulic leveling system may be optionally equipped with manually operated coach stabilizers.

Coach stabilizers are intended to provide firmness to the floor of coach after it has been leveled using blocks or Jet Air Ride system.

WARNING

Stabilizers are not intended to be used as jacks to level the coach or to work on the vehicle. Misuse may result in personal injury or damage to the vehicle.

To Use Stabilizers

1. Squeeze handle and slide foot pad off storage peg.
2. Swing leg down. Squeeze handle to lower foot pad to ground.

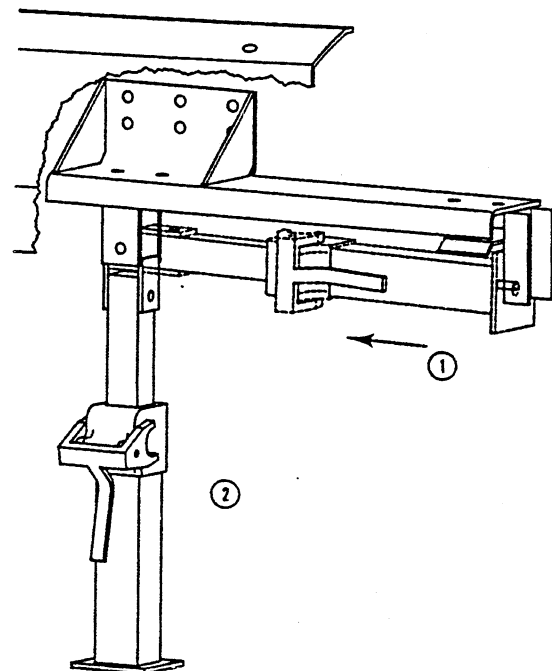

3. Use 3/4" wrench to extend stabilizer until firm to the ground.

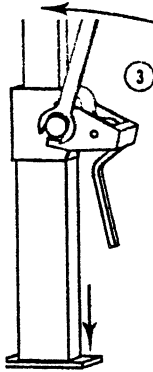
**IMPORTANT**

Do not attempt to over-extend leg. This can result in leg tube becoming stripped out. Do not attempt to lift or level coach!

CAUTION

Be sure stabilizers are returned to storage position before driving off.

SECTION 3 IN CASE OF DRIVING EMERGENCY

HAZARD WARNING FLASHER

The hazard warning flasher provides additional safety when the vehicle must be stopped on the side of the roadway, presenting a possible hazard to other motorists. When the flasher is on, it warns other drivers to approach and overtake your vehicle with caution.

WARNING

Operating the hazard warning flasher system while moving on the highway is illegal.

The front directional signals and the taillights will flash intermittently when the flashers are in use. The hazard warning flashers will not operate when the service brake pedal is depressed. The turn signal will not operate when the flashers are on. When it is necessary to leave the vehicle, the flasher system will continue to operate with the ignition key removed.

IF YOU GET A FLAT TIRE

In case of sudden tire failure, avoid heavy brake application. Gradually decrease speed. Hold steering wheel firmly and move slowly to a safe, off-road place. Park on a level spot, turn off the ignition, and turn on the hazard flasher system.

Spare Tire Storage

The spare tire is located in the trunk compartment on the rear of the vehicle.

MOTOR HOME TIRE CHANGING PROCEDURE

WARNING

We advise you to obtain qualified road service whenever possible. Do not try to change a tire yourself except under emergency conditions, and only by closely following instructions in this manual and the chassis operating guide.

If you do satisfactorily complete an emergency tire change, we recommend that you have the wheel nuts checked and properly torque tightened by qualified service personnel as soon as possible.

After a wheel has been properly torqued and inspected by qualified service personnel, it should be rechecked after traveling 100 miles, then again at each oil change.

IMPORTANT

The jack referred to in the following instructions is not supplied with the vehicle. You can obtain one from your dealer.

A jack is designed for use as a tool for changing tires only, not for use as a leveling device or as a support when servicing.

WARNING

Tire change procedures should be used in emergency situations only. The operator is advised to obtain qualified road service when possible.

SAFETY PRECAUTIONS

Before trying to change either the front or rear tires, follow these precautions:

1. Park vehicle on level surface only.
2. Turn off engine and set parking brake.
3. Turn on hazard warning flasher.
4. Block both front and back of wheel opposite wheel to be removed.
5. On soft ground, use a board or other material under jack as a firm base to ensure that the jack will not shift.

JACKING POINT ON VEHICLE

MODELS	FRONT	REAR
All	Lower Control	Under Axle

Front Wheel

Before trying to remove the front wheel, observe the above safety precautions, then follow the procedure below:

1. Turn the jack extension out to approximately ground-to-spring height.
2. Position jack under lower control arm.

NOTE: Lower control arm base must be supported by the jack. Begin jacking until the jack is firmly positioned, but do not jack tire off the ground.

3. Loosen wheel nuts with lug wrench.
4. Resume jacking until wheel is free of ground.
5. Remove wheel nuts and wheel; put spare wheel in place.
6. Install wheel nuts and tighten as much as possible with wheel and tire off the ground.

7. Lower tire until tire just contacts the ground. Tighten nuts with lug wrench in sequence recommended by chassis manufacturer.
8. Finish lowering jack, then remove jack and blocks.

WARNING

Upon satisfactory completion of emergency tire change, it is highly recommended that wheel nuts be properly torqued and inspected by qualified service personnel as soon as possible.

Dual Rear Wheels

Before trying to remove the rear wheel, follow safety precautions in the beginning of the motor home jacking procedures. Then follow the procedure below:

1. Turn jack extension out to about ground-to-axle tube height.
2. Place jack under axle housing near wheel to be raised. Center jack on the housing so vehicle will not slide off jack. Place jack far enough inboard on the axle housing so that when the handle is inserted, the jack may be operated from either in front or behind the tire without crawling under the vehicle.
3. Begin jacking, but DO NOT lift wheel and tire off the ground.
4. Loosen wheel nuts with lug wrench.
5. Resume jacking until wheel and tire are free of ground.

NOTE: Full torque must be applied to dual rear wheel nuts with both wheels off the ground.

WARNING

DO NOT crawl under the vehicle when it is supported by a jack.

6. Remove wheel nuts and wheel.

IMPORTANT

When installing the outer dual wheel and tire assembly, rotate the wheel so that an outer wheel cutout, without the tire valve, is opposite the inner wheel tire valve.

NOTE: When installing or tightening dual wheels, both wheels on the same side must be off the ground (not resting on the inner dual). This lessens the chance of loose wheels after correct mounting torque is applied.

7. Mount spare wheel on studs and replace wheel nuts. Refer to your chassis operating guide for wheel nut torque and tightening sequence.

Wheel Nuts

To properly seat the wheel nuts and to eliminate the possibility of the wheel nuts becoming loosened while driving, they should be tightened at frequent intervals to the torque specified in your chassis operating guide. This is especially important after the first 100, 1,000 and 6,000 miles of operation after replacement of a wheel or wheel nuts.

RECOVERY TOWING

These instructions are intended to help the towing operator prepare the motor home. Correct preparation is necessary to avoid damage to motor home body and chassis parts.

Winnebago does not assume responsibility for damage incurred while towing this vehicle.

NOTE: Consult the chassis operating guide for any additional towing instructions provided by the chassis manufacturer.

1. Remove front bumper.

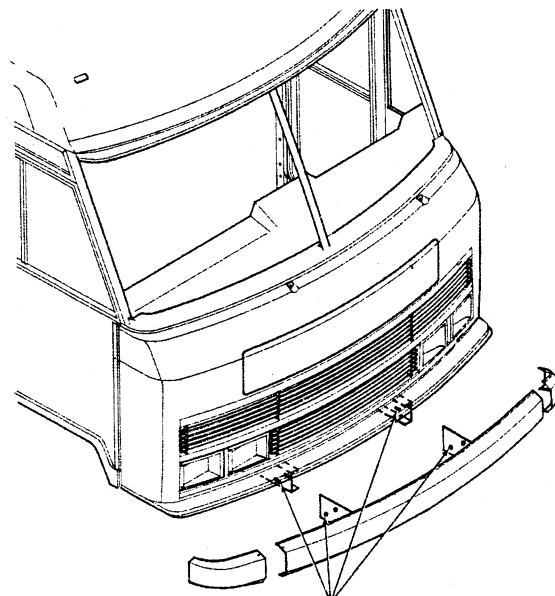

Front Bumper Mounting Bolts

CAUTION

Do not lift on bumper. Damage will result to front end body parts.

2. Attach tow hooks where they will not damage brake lines, or suspension or steering parts.
3. Place a 6" x 6" (minimum) beam beneath the original chassis rails just behind the forward chassis extensions.
Then place a 4" x 4" beam beneath the extensions ahead of the automotive battery tray as shown below.

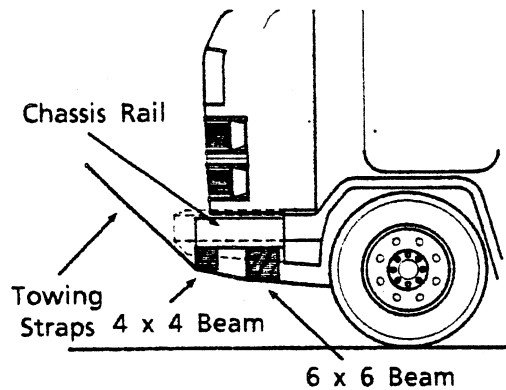

TOWING ATTACHMENT

4. Be sure towing straps, cables or chains do not touch grille or front body shroud.
5. Use a safety chain system that is completely independent of the primary lift/tow assembly.
6. Secure any loose or protruding parts of damaged vehicle before towing.

WARNING

Stay out from beneath the motor home while it is suspended by the towing assembly unless the vehicle is adequately supported by safety stands. Do not allow passengers to occupy a towed vehicle.

IMPORTANT

Know and obey all state and local towing regulations. Tow at reduced speed.

JUMP STARTING

WARNING

Automotive batteries produce caustic acid, explosive gases, and electrical current which may cause burns. It is important that the instructions below are followed **exactly**, or personal injury (particularly to eyes) or property damage may result due to battery explosion, battery acid, or electrical (short circuit) burns.

- NEVER smoke near the battery or expose it to open flame or electrical sparks.
- Wear eye protection or shield your eyes while working near either battery, in case an explosion does occur. NEVER lean over a battery.
- Do not allow battery fluid to contact eyes, skin, clothing, or painted surfaces. Immediately flush any contacted area with water. If eyes are affected seek medical help after flushing.
- Remove all metal jewelry to lessen the risk of a short circuit occurring.

Connecting Jumper Cables

1. Make sure that the other vehicle has a 12-volt battery and negative ground compatible with your vehicle's electrical system.
2. Position the vehicle with the good battery so that the jumper cables will reach, but **do not allow the vehicles to touch**.
3. Turn off all electrical accessories, motors, and lights except those needed for safety or to light up the work area. Place automatic transmission in P (Park). Be sure parking brakes are engaged in both vehicles.
4. If the weak battery has filler caps, make sure the electrolyte is at proper level. Add distilled water if fluid is low. If electrolyte is not visible or appears to be frozen - **do not attempt jump starting!** A battery may rupture or explode if the electrolyte is frozen or not filled to the proper level.
5. Connect one end of the positive "+" (red) jumper cable to the positive "+" terminal of the weak battery. Connect the other end to the positive "+" terminal of the charged battery.
6. Connect one end of the negative "-" (black) jumper cable to the negative "-" terminal of the charged battery.
7. Finally, connect the remaining end of the negative "-" (black) cable to a solid, metal grounded location on the engine of the

vehicle with the weak battery, at a point at least 18 inches from the battery.

Do not connect to any moving parts.

THE MAIN SAFETY PRECAUTION IS TO MAKE THE FINAL GROUND CONNECTION ON THE ENGINE AT A SAFE DISTANCE FROM THE BATTERY. THIS HELPS TO REDUCE THE CHANCE OF EXPLOSION DUE TO SPARKS.

8. Start the engine of the vehicle with the charged battery, and allow it to run for a few minutes at moderate r.p.m. Then start the engine of the vehicle with the discharged battery.
9. Reverse the above sequence EXACTLY when removing the jumper cables. Start by removing the cable from the ground location on the engine first, then continue in reverse sequence.

WARNING

Do not attempt to push-start this vehicle. Damage to the transmission or other parts of the vehicle could occur.

CONNECTING A BATTERY CHARGER

CAUTION

Disconnect the radio power fuse before attaching a battery charger or jumper cables to the battery. The radio tuner may become damaged if this is not done.

To connect a battery charger, first make sure the engine is switched off. Disconnect the positive lead from the battery. Never disconnect the battery while the engine is running or alternator damage could result.

Connect the positive "+" (red) lead of the charger to the positive "+" terminal on the battery. Next, connect the negative "-" (black) lead of the charger to a suitable ground. Finally, plug in or switch on the charger.

To disconnect the charger after charging, unplug the charger from the electrical outlets, remove the charger leads from the vehicle, and reconnect the vehicle leads to the battery.

ENGINE OVERHEAT

If you see or hear steam escaping from the radiator or the engine compartment or have any other reason to suspect an extreme engine overheating condition, pull the vehicle over to the roadside as soon as it is safe to do so, stop the engine and get out of the vehicle.

WARNING

Operating a vehicle under a severe overheating condition can result in damage to the vehicle and may result in personal injury.

An engine will overheat if the coolant is low or there is a sudden loss of coolant because of one or more of the following:

- a leak in the cooling system
- a hose failure
- a drive belt breaking
- water pump failure

Also, be aware of the following situations, which can cause temporary engine overheating:

- climbing a long hill on a hot day
- idling while stopped in traffic for long periods of time
- towing a trailer or automobile
- stopping after a period of high speed driving

If the TEMP indicator on the instrument panel shows a rise in engine coolant temperature while driving, take the following steps to try to lower the overheating:

- If you are using the automotive air conditioner, turn it off.
- If you are stopped in traffic, shift the transmission into P (Park), and engage parking brake.

If the temperature does not drop within a minute or two:

- Pull the vehicle over to the roadside as soon as it is safe to do so.
- Place the transmission in P (Park) and press the accelerator to increase engine speed (r.p.m.'s) to twice that of normal idle speed, and hold it there for approximately two or three minutes.
- If engine temperature does not go down, turn the engine off. Wait until the engine has cooled before opening the hood.

When no trace of escaping steam is heard or seen, open the hood to check for the cause of the overheat. Check hose connections and tighten if necessary. Make sure there are no broken belts, pulleys or hoses before adding any coolant to the radiator.

For further information about overheating, consult your chassis operating guide.

SECTION 4 TRAVELING WITH YOUR MOTOR HOME

(See also SAFETY PRECAUTIONS, Section 1 of this manual.)

LOADING THE VEHICLE

When loading the vehicle, distribute the cargo load equally so that you do not exceed either the Front or Rear Gross Axle Weight Rating (GAWR) or the Gross Vehicle Weight Rating (GVWR). Have your vehicle weighed to determine the proper load distribution for your vehicle. The GVWR is listed on the Vehicle Certification Label.

The total combined weight allowed for the vehicle, including trailer towing load weight, is known as the Gross Combined Weight Rating (GCWR). If trailer towing is not recommended, the GCWR will equal the GVWR.

Your cargo capacity will vary according to the options equipped on your vehicle, and any additional equipment and parts that you have installed, which were not supplied with the vehicle. **Do not exceed** any of the recommended weight ratings.

NOTE: We recommend that you dump all holding tanks before traveling to avoid carrying unnecessary weight.

CAUTION
The weight of the loaded vehicle (including options, attachments, passengers, water, fuel, luggage and all other cargo) must not exceed the GVWR or GAWR of either axle.

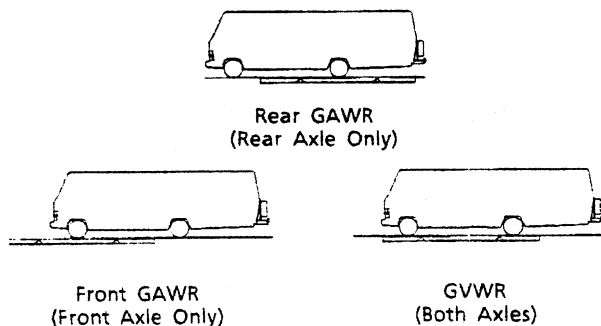

Weighing Your Motor Home

We recommend that you have the front suspension and steering alignment checked and adjusted after you have fully loaded the vehicle according to your needs. Thereafter, have alignment inspected periodically to maintain vehicle steering performance and prevent uneven tire wear.

ROOF LOADING

The roof is capable of carrying some lightweight articles while the vehicle is in motion. A roof-mounted luggage carrier designed for this purpose is available from your dealer. However, minimum roof load while the vehicle is in motion is not to exceed 10 pounds per square foot or a maximum of 100 pounds.

When the vehicle is stationary, a cargo load of 100 pounds plus the weight of a 225 pound person to load the cargo or to conduct inspection and maintenance is permissible.

Weight added to both the roof and the trailer hitch contribute to the gross vehicle weight, which must not exceed the vehicle's GVWR.

TRAILER TOWING

Vehicles which are equipped with factory installed trailer hitches have a towing capacity label affixed to the rear of the vehicle.

TOWING CAPACITY	
TOWED VEHICLE	* LB. GROSS MAXIMUM
HITCH BALL	* LB. MAXIMUM

*SEE THE LABEL ON YOUR VEHICLE FOR WEIGHT LIMITATIONS

Because of individual vehicle use and loading habits, we recommend weighing the vehicle while fully loaded to avoid exceeding any of the listed Gross Weight Ratings. Refer to the illustration "Weighing Your Motor Home" at left. See "Vehicle Certification Label" for information on gross weight ratings.

Towing will affect vehicle handling, durability and fuel economy. Exceeding any of the listed Gross Weight Ratings will result in unacceptable overall vehicle performance. Maximum safety and satisfaction when towing depends on proper use of correct equipment.

Installation of a proper trailer brake system is recommended. Check state regulations on trailer weight and trailer brake requirements to be sure you select the right equipment before towing.

Before descending a steep or long grade when towing a trailer, reduce speed and shift into a lower gear to control vehicle speed. Avoid prolonged or frequent application of brakes which could cause overheating and brake failure.

WARNING

For safe towing and vehicle handling, maintain proper trailer weight distribution.

The total weight of the motor home and the vehicle towed must not exceed the Gross Combined Vehicle Weight rating. Contact the chassis manufacturer to obtain the Gross Combined Vehicle Weight rating for your chassis.

CAUTION

Exceeding any of the recommended gross vehicle weight ratings may result in vehicle damage.

Do not install a frame equalizing type hitch on your vehicle.

PRE-TRAVEL CHECK LIST

Before starting the engine to leave on a trip, be sure your motor home has been properly prepared and maintained. This will ensure an enjoyable trip and help avoid delays. Use this checklist as a guide.

- Fluid Levels - Check and fill if necessary:
 - engine oil
 - transmission
 - power steering
 - radiator
 - brake
 - battery
 - windshield washer
- Wheel Lug Nuts - Check for tightness.
- Tires - Check for proper cold inflation pressures as specified on the Vehicle Certification Label.
- Drive Belts - Check for proper condition and tension (not cracked, frayed or loose, etc.).
- 110-Volt Generator (Optional) - Check oil level in generator engine.

WARNING

Never check oil level in generator while engine is operating.

- Fire Extinguisher - Make sure it is fully charged and secured in mounting bracket.
- Lights - Make sure all exterior lights operate.

- Sewer and Water Supply Hose - Unhook and store.
- TV Antenna - Make certain the TV antenna is completely lowered.
- Loose Items Inside the Motor Home - Store or secure items.
- Pilot Lights - Make sure all pilots are off.
- Fuel Tanks - Check level.
- Water Tank - Fill with fresh water.
- Exterior Door and Step - Make sure doors are closed, locked and step retracted.
- Seats - Adjusted for comfortable position and locked in place.
- Mirrors - Adjust for maximum visibility from driver's seat.

EQUIPPING FOR TRAVEL

When beginning a trip, several items should be taken in addition to the basic clothes, food and recreational items. A checklist is provided for your convenience. Remember, it is important to distribute weight and store all heavy items near the floor.

EMERGENCY EQUIPMENT CHECKLIST

- Flashlight
- First Aid Kit
- Road Emergency Flares
- Tool Box with Assortment of Hand Tools
- Plastic Bucket
- Tow Chain or Rope
- Wheel Blocks or Extra Jacks for leveling
- Water Hose
- 100-150 Feet of 3-Wire Electrical Cord with at least 30 AMP Capacity
- Fire Extinguisher
- Hydraulic Jack and Lug Wrench
- Spare Tire

QUICK LOADING CHECKLIST**BEDDING**

- Sleeping Bags
- Sheets
- Pillow Cases and Pillows
- Mattress Pads
- Extra Blankets
- Laundry Bags

COOKING

- Can Opener
- Bottle Opener
- Aluminum Foil
- Matches
- Plastic Bags
- Coffee Pot
- Storage Dishes

CLEANING

- Scouring Pads
- Cleanser
- Glass Cleaner
- Dish Soap
- Sponge
- Laundry Soap
- Cleaning Rags or Paper Towels
- Garbage Bags

BATHROOM

- Bath/Hand Soap
- Bath Towels that can double as Beach Towels
- Toiletry Kits
- Toothbrushes and Toothpaste
- Shaver/Razors
- Toilet Tissue (RV)

BABY NEEDS

- Car Seat (Child Restraint)
- Portable-Crib
- Play Pen

PERSONAL

- Credit Card(s)
- Traveler's Checks
- Money
- Driver's License
- Proof of Citizenship (for Canadian or Mexican crossing)
- Sunglasses

PET NEEDS

- Food
- Leash
- Water and Food Dishes
- Proof of Rabies Shot

MISCELLANEOUS

- String
- Clothesline
- Insect Repellent
- Masking Tape

TRAVEL TIPS

As you travel around the country in your motor home, you will pick up useful advice from other motor home owners.

A number of suggestions can also be obtained by reading articles and regular columns in outdoor and camping magazines. Some magazines and publishing companies print an annual park and campground directory. These can be found at your local newsstand or RV supply dealer. Here are a few travel tips to begin with.

1. Always check for sufficient clearance. Know the height and width of your unit.
2. Always fill the fresh water tank at an approved potable water filling facility or a known purified drinking water source. Taste the water before filling the water tank in an unfamiliar location. The water in some areas may contain an undesirable taste. Do not use a new hose to fill the water tank. It can leave a distinct rubber or vinyl taste.
3. Showers can take a lot of water. Conserve water by taking a "Sea Shower". This is done by wetting down, turning off the water, soaping thoroughly and then rinsing.
4. Dump sewage only at approved dumping stations.
5. Store liquids in plastic containers with tight fitting caps to prevent spills.
6. Keep an eye on the water and holding tank levels. It is a good idea to dump the holding tank at least every two days.
7. When traveling with children, it is helpful to plan their wardrobe for a week. Place each days clothing in a plastic bag and label the bag with the child's name and day of the week for use.
8. Use sleeping bags whenever possible. They save laundry and take up less storage space than bedding.
9. Make sure all compartment doors have been closed and the door step has been stowed in the correct position before moving the vehicle.
10. Before traveling, make sure the refrigerator door has been secured. Use care when opening the refrigerator door after the vehicle has been stopped. Any articles that have shifted may fall out when the door is opened.
11. During peak tourist season and holidays, it is best to phone ahead and make reservations at the park where you plan to stop.
12. Some states or cities will not permit vehicles with LP gas containers to pass through highway tunnels. If your route includes a tunnel, check with the highway patrol or department of highways to avoid inconvenience.
13. Do not leave food or odor-causing material in your vehicle for extensive periods of time. Always allow damp clothing, swimwear, hunting gear, etc., to dry before stowing.
14. Become familiar with the fire extinguisher and make sure it is always fully charged. Remove and replace it and read instructions so you know the correct operating procedure before an emergency happens.
15. Make a list of all groceries, fresh meats, vegetables, newspapers, etc., that you may need and try to pick them up during your last

fuel stop of the day. This will prevent leaving a good parking spot once you have arrived at your destination.

16. When you sit over the front wheels while driving, as in a motor home, you have a tendency to crowd the middle of the road. Check the side view mirror frequently to observe how close you are driving to the center line.

Humidity and Condensation

Fogging may appear on the windows when there is excessive humidity inside the coach. In extremely cold weather this can become frost or even ice. To help reduce excess moisture, partially open a window or roof vent. Operating the range hood vent or powered roof vents will also help.

SEVERE WEATHER INFORMATION

One of the more serious conditions affecting the motor home traveler and camper is that of the weather. Whether you travel the high mountain terrain, the lower deserts and flatland or the plains of the midwest, the weather is always with you and subject to change, sometimes with little or no warning. However, adequate warnings are normally broadcast over local radio and TV stations.

Motor home travelers and campers often seek secluded areas for weekend recreation or extended summer vacations. Many recreational areas are vulnerable to severe weather situations, especially flash flooding conditions. A few simple precautions may help lessen the hazards of flash flooding or reduce your immediate involvement.

IMPORTANT

We recommend that all motor home occupants become familiar with these safety precautions, and be alert to changes in weather.

- Be alert, because thunderstorms can form at any time, in any month of the year. Thunderstorms can produce large amounts of rain over a small area in a short time, which may result in a flash flood. Listen frequently to weather reports on the radio for weather and flood conditions.
- When camping near a stream, leave plenty of sloping bank between you and the stream.
- Avoid deep canyons and dry washes during stormy or threatening weather. Be aware of alternate exits.

- If heavy rain occurs, move to high ground immediately (at least 30-40 feet above the canyon floor or bottom of dry wash).
- During a flash flood, if you cannot move your vehicle, abandon it. Do not attempt to return to your vehicle before the water has receded.
- Do not attempt to wade to your vehicle if the water is above your knees - fast moving water exerts an enormous amount of pressure, making it impossible to remain standing or walking.
- Do not try to drive through flooded areas.
- Follow instructions of local authorities. Leave immediately when advised to do so. Many lives have been lost because people did not heed warnings.
- Have on hand survival supplies for several days, including food, water, first aid equipment and necessary medications. In desert areas during hot weather allow 3-4 gallons of drinking water per person, per day.
- Before you leave home, inform someone of your destination and when you expect to return. Authorities at your destination should be notified immediately if you do not arrive on time.

REMEMBER THESE TERMS:

WATCH: Severe weather may develop in the specified area. Be alert and prepare for possibility of an emergency.

WARNING: Severe weather is occurring, or is imminent in certain areas. Move to a safe location immediately.

We highly recommend that you obtain a weather radio. These radios offer up-to-date weather reports. The latest information and forecasts are broadcast by local National Weather Service offices in recorded messages that last from three to five minutes. These messages are replayed continually 24 hours a day. The recorded messages are revised every three to four hours, or more frequently when appropriate.

When severe weather threatens, forecasters at the local National Weather Service office interrupt the broadcasts with storm warnings, either recorded or "live" as the situation demands.

The frequencies used for NOAA Weather Radio (National Oceanic and Atmospheric Administration) nationwide are 162.40, 162.475 or 162.55 megahertz.

NIGHTTIME DRIVING

- Make sure all running lights and signal lights are clean and in working order. Have your headlights periodically checked and adjusted.
- Use care when passing other vehicles. Your motor home is a longer vehicle than a car, and you may have a more difficult time knowing when to pull back into your lane. If possible, have another person in the coach help you watch while maneuvering your motor home in traffic.

MOUNTAIN DRIVING

Special techniques must be used when driving in mountainous or hilly country.

Climbing a Hill

The transmission will automatically downshift as needed to climb most hills. If the hill is long or very steep, however, you may need to manually shift to a lower gear to keep the transmission from repeatedly upshifting and downshifting. See your chassis operating guide for more information.

CAUTION

Observe the engine temperature gauge more frequently than normal. If overheating occurs, pull off to the side of the road and allow the engine to thoroughly cool before refilling the radiator and restarting the engine.

Descending a Hill

When going down a long grade, you may need to manually shift to a lower gear, rather than keeping your foot on the brake pedal. A lower gear will allow the engine to provide a degree of braking action. Holding your foot on the brake pedal for an extended period may cause brakes to overheat, causing you to lose control of the vehicle. See your chassis operating guide for more information.

Campsite Selection

Try to pick as level a spot as possible on which to park your motor home. Whether you nose into a parking site or back into it depends on personal preference and the location of the site's utility hook-ups. Remember that the utility connections on your motor home are on the left (driver) side of the vehicle.

Leveling

Leveling the motor home is very important, not only for your comfort but for appliances and plumbing as well. Some refrigerators are extremely sensitive to being unlevel. The ammonia vapor cooling system used in most RV refrigerators can "lock up" and damage the refrigerator if it is not level. This is both inconvenient and costly. Also, water and holding tank level indicators may give false readings because water level is greater at one side of the tank than the other.

The refrigerator is installed level at the factory. So, if the refrigerator is level, the motor home is level. A small bubble-level sight is included in the refrigerator to help you determine refrigerator leveling.

A motor home can be leveled using several methods including sophisticated electronic-hydraulic systems. The most common and inexpensive method, however, is to use wooden blocking under the down-side wheels.

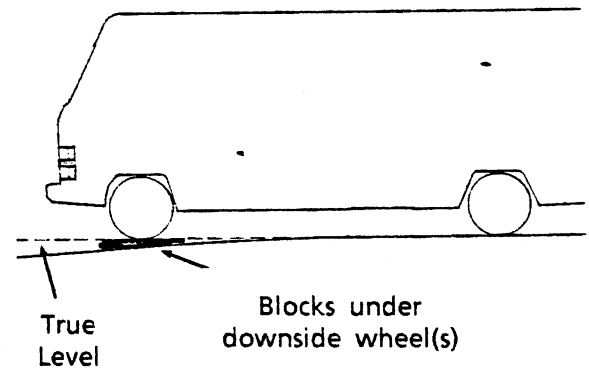

Leveling Your Motor Home

Blocking

You will need:

Blocks - an assortment of wooden blocks and planking to stack and drive the lower wheel(s) onto.

Jacks - to place under the frame to make the floor solid, not moving on the suspension springs. Inexpensive mechanical or hydraulic ("bottle") jacks work fine. These are not intended to lift the vehicle; only to hold it steady.

We do not recommend lifting any of the wheels off the ground for leveling. This could cause the vehicle to roll off the jacks, possibly resulting in damage to the vehicle.

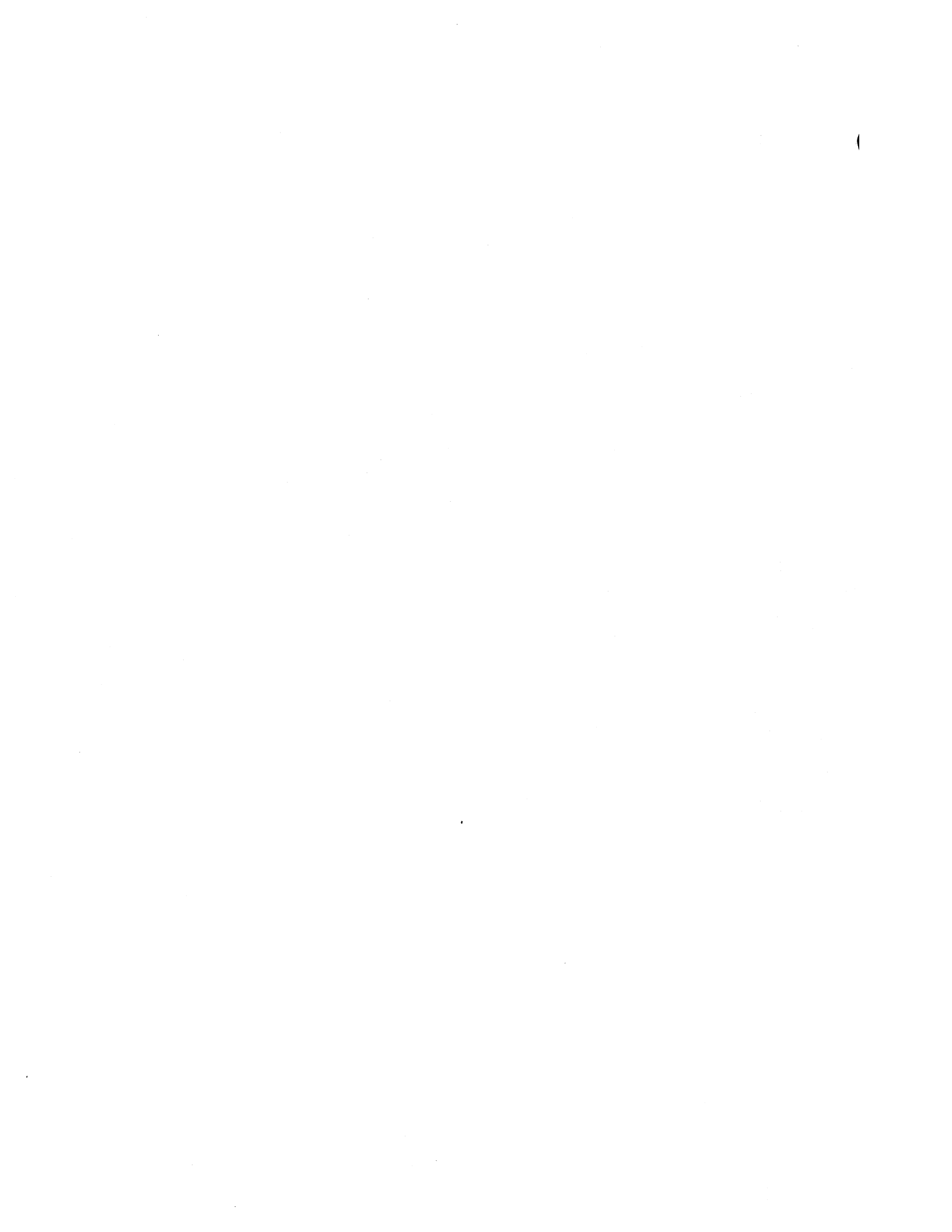

SECTION 5

LP GAS SYSTEM

(See also Safety Precautions, Section 1 of this manual.)

LP GAS SUPPLY

The LP gas system supplies fuel for the range, water heater, furnace and refrigerator (while in gas mode). When used and handled properly, this system is safe and economical and provides modern living conveniences wherever you travel.

SAFE USE OF THE LP GAS SYSTEM

- Exercise caution at all times. Be familiar with the distinctive odor of LP gas. If a leak is suspected, turn off the supply valve immediately. Have the LP gas system checked by your dealer or a qualified LP gas service center.
- Be sure that the LP gas leak gauge is operating properly. Perform the recommended tests daily. Refer to the manufacturer's information in your Motor Home Operation Manual for further instructions.
- Do not tamper with the LP gas piping system, pressure regulator or gas appliances. Service and maintenance of LP gas system components should be performed only by your dealer or a qualified LP gas service center.
- Never attempt to connect natural gas to the LP gas system.
- Have the entire LP gas system inspected for possible leaks and missing or damaged parts at each tank filling. Also inspect before and after each trip, and any time trouble is suspected.
- Turn the LP supply valve off when not using the LP gas system.
- Never use a wrench to tighten the tank supply valve. It is designed to close leak-tight by hand. If a wrench is required to completely close the valve, it is defective and must be replaced.
- Never allow the tank to be filled above the 80 percent level indicated by the flow of liquid gas out of the overflow valve or by the automatic stop-fill device.
- Be sure appliance and outside vents are open and are not obstructed when using the LP gas system.
- Never attach a lock or any device requiring a key to the LP tank compartment door. According to standards set for recreation vehicles, the LP supply valve must be readily accessible in an emergency.
- Exercise caution when drilling holes or attaching objects to the walls. Gas lines and electrical wiring could be seriously damaged and present an extreme safety hazard.

How LP Gas Works

LP (Liquified Petroleum) gas is a true gas compressed into liquid form for easy transportation and storage. It is known by several names such as tank gas, bottled gas or simply as butane or propane, which are the two types of LP available.

LP is used by appliances in vapor form only, but is stored in the tank as a liquid under very high pressure. As the liquid gas is released, it reverts back to a vapor and expands to many times its compressed volume.

Selecting Fuel Types

Butane burns hotter than propane, but will not develop a usable gas vapor at temperatures lower than 32° F. Propane, on the other hand, does not burn as hot but will convert to usable gas at temperatures down to -44° F. For this reason, propane is popular in cold climates, while butane and propane/butane mixtures are used most widely in milder climates.

IMPORTANT

Most LP dealers normally handle only the type of LP gas commonly used in their climate and area. If you anticipate filling your tank in one of the warmer states prior to traveling to a colder area, it is advisable to request propane only. Otherwise your LP system may fail to operate if the temperature drops below 32° F.

LP Gas Output

Each gallon of liquid LP gas contains approximately 92,000 BTU's of heat energy; or putting it another way, each gallon of LP gas produces approximately 36.2 cubic feet of dry gas for heating, cooking, water heating and refrigeration.

LP gas tank capacities are often listed in pounds rather than gallons. A gallon of LP weighs 4.24 pounds, so 80 pounds of LP equals about 19 gallons. LP tanks can only be filled to 80% of their total capacity, so an 80-pound tank would actually hold 64 pounds, or about 15 gallons.

To find out how long a gallon of LP gas will last, you should determine the total BTU input on all your LP gas appliances in use. Let's say you have a heater that has a 10,000 BTU input per hour of operation. A gallon of LP gas would last 9.2 hours of continuous operation (92,000 divided by 10,000 = 9.2). To estimate how long a gallon of LP gas lasts, try to determine what your total daily BTU input is, then divide into 92,000 to arrive at an approximate daily LP gas consumption.

WARNING

Test the LP system with the leak detector each time the gas valve at the tank is turned on. Never attempt to connect natural gas to the LP gas system.

LP TANK SYSTEM

The storage reservoir for the LP gas system is a horizontally mounted tank which is permanently attached to the vehicle frame. The tank is accessible only from the outside of the vehicle. The tank supply valve is located near the top center of the tank, next to the regulator. Before opening the supply valve, check to be sure all controls for gas appliances are in the "Off" or "Pilot Off" position. If this step is not performed, LP gas could accumulate inside the motor home creating a fire or explosion hazard.

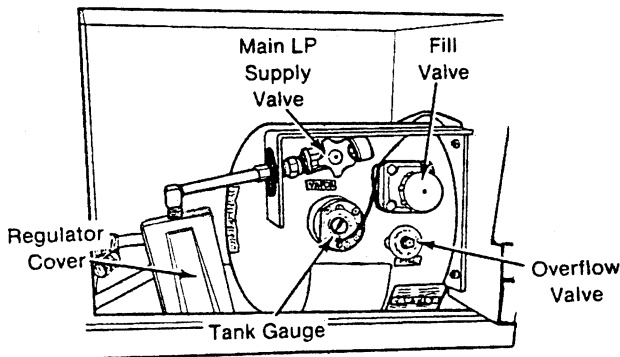

Typical LP Gas System Controls

Refilling LP Tank

There are many LP gas refueling stations located throughout the country. These stations are listed in the telephone directory Yellow Pages under "Gas - Liquefied Petroleum - Bottled and Bulk."

Since the LP tank is permanently mounted to the frame, the motor home must be taken to an LP dealership for filling. Do not attempt to remove the LP tank from the vehicle. The tank is equipped with a fill adapter with both internal and external threads which allows easy filling with any LP filling equipment. The tank is full when liquid LP gas appears at the overflow valve.

NOTE: The LP tank is equipped with an automatic 80% stop-fill device.

WARNING

Make sure the filling attendant uses the 80% overflow valve when filling the tank. A tank should never be filled above the 80% level to allow for vaporization and liquid expansion.

Do not place LP gas containers inside the vehicle. LP gas containers are equipped with safety devices which relieve excessive pressure by discharging gas to the atmosphere.

Do not place LP gas containers, gasoline, or other flammable liquids inside the vehicle. Fire or explosion may result.

Air in the LP Gas Tank

If your LP gas appliances do not stay lit or require frequent adjustment, even though you know the LP tank contains sufficient fuel, the problem may be air in the LP gas tank. Air in the tank mixes with the LP gas vapors causing them to burn poorly. This condition could linger for weeks if the air is not purged from the tank. Most LP gas dealers have equipment for purging air from LP gas tanks and will purge before refilling the tank.

TRAVEL WITH LP GAS

It is illegal for vehicles equipped with LP tanks to travel on certain roadways or through certain tunnels in the U.S. To avoid inconvenience, check state regulations concerning flammable gas transportation.

WARNING

Do not alter or remove LP tank gauge at any time.

WARNING

DO NOT FILL CONTAINER TO MORE THAN 80 PERCENT OF CAPACITY. Make sure the motor home is level when filling. It is possible to accidentally overfill the tank if the vehicle is unlevel, with the fill valve on the uphill side. Overfilling the LP gas tank can result in uncontrolled gas flow, which can cause fire or explosion. A properly filled container will contain approximately 80 percent of its volume as liquid LP gas.

All pilot lights must be extinguished and supply valve closed before refilling LP gas tanks or vehicle fuel tanks.

Do not smoke or expose an open flame while near an LP refueling area. LP gas is heavier-than-air and extremely flammable.

Never use an open flame to test for LP gas leaks.

Replace all protective covers and caps on LP system after filling.

Never fill the LP tank with engine or generator running.

REGULATOR

The pressure regulator is protected from the elements by a plastic cover which should be left in place at all times. Only your dealer or a qualified LP gas service should remove the regulator cover for adjustments.

WARNING

Inspect the pressure regulator vent hole periodically for blockage. If any obstruction is apparent, have the regulator serviced by your dealer or a qualified LP gas service center.

LP gas regulators are installed with the diaphragm vent facing downward. Make sure that the regulator vent always faces downward to minimize vent obstruction which could result in excessive pressure, causing a fire or explosion.

Regulator freeze-ups are caused by the presence of moisture in fuel. This moisture will pass through the cylinder valve and into the

regulator where it can freeze. Fuel producers, tank and bottle manufacturers and LP gas dealers take every precaution to reduce moisture, but sometimes only a fraction of an ounce entering the tank can cause problems. To help avoid the possibility of freeze-up, always keep tank control valve closed when not in use, even when tank is empty, to prevent moisture from collecting on the inside.

If regulator freeze-up should occur, you may attempt to thaw the regulator using a light bulb. **DO NOT USE AN OPEN FLAME OR HEAT LAMP.**

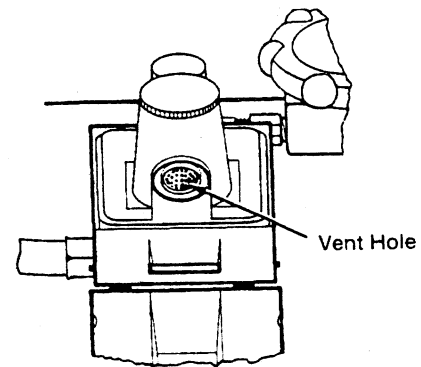

LPG PRESSURE REGULATOR
(Cover Open)

If moisture begins to cause problems, have your LP gas dealer inject a small amount of dry methyl alcohol in your tank (approximately one ounce to 20 pounds or one pint to 100 gallons) to help guard against regulator freeze-ups.

In very cold weather when a large volume of gas is being used for heating, it is possible to experience a loss of gas pressure. At first, this problem may appear to be caused by a regulator freeze-up, but is actually caused by failure of the liquid gas to vaporize as fast as it is needed. As the temperature becomes colder, it is increasingly harder for the liquid LP gas to vaporize. At the same time, the demand for LP to produce heat increases to the point where the system cannot maintain production.

The only actual solution to this problem is to reduce the consumption of gas where possible. Adjusting the temperature on the gas/electric refrigerator may be a first step. Using less hot water will help as well.

LP GAS LEAKS

The following label has been placed in the vehicle near the range area. If you smell gas within the vehicle, quickly and carefully perform the procedures listed.

IF YOU SMELL GAS

1. Extinguish any open flames, pilot lights and all smoking materials.
2. Do not touch electrical switches.
3. Shut off the gas supply at the tank valve(s) or gas supply connection.
4. Open doors and other ventilating openings.
5. Leave the area until odor clears.
6. Have the gas system checked and leakage source corrected before using again.

LP Leak Gauge

Your coach is equipped with a pressure-drop indicator gauge (manometer) to test for LP gas line leaks. This gauge is located in the refrigerator access compartment on the exterior of the coach and is easily accessible when required. A leak test should be performed before using the LP system in the following situations:

- after storage periods
- each time after opening the main supply valve
- after each LP tank fill
- daily during periods of extended use

Read the following operating instructions and additional information in your Owner Operation Manual before conducting the LP gas leak test.

IMPORTANT

This device does not prevent leaks. It detects and indicates leakage only while operated and observed.

If the gauge indicates a leak, recheck to be sure all appliance gas valves have been shut off.

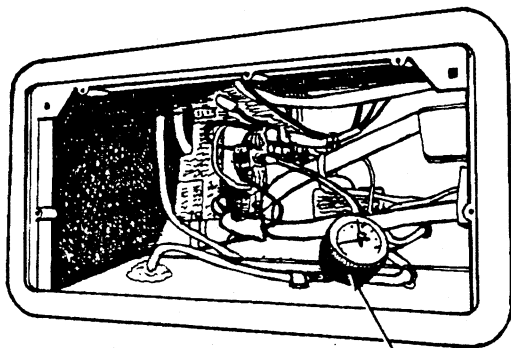

Leak Gauge

(Located in Refrigerator Compartment)

WARNING

Do not smoke or expose the unit to open flame or extreme heat when conducting an LP gas leak test. Never use an open flame to test for gas leaks.

Instructions:

1. Close LP gas tank supply valve(s).
2. Ventilate vehicle. Open doors and windows.
3. Shut off LP gas appliances, including pilots.
4. Slowly open LP gas tank supply valve(s).
5. Move the adjustable red needle (B) on the leak gauge to the same position as the black needle (A). The black needle indicates the line pressure. The red needle is simply a marker.

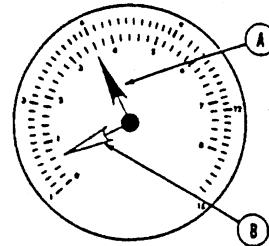

6. Close tank supply valve and monitor the position of the black needle for 5 minutes. If the black needle:
 - A. Stays aligned with the red needle, the system is leak-free at this time. Skip #7 & #8 - test is complete.
 - B. Drops to a lower position than the red needle, the system has a leak. Go on to step 7.
7. Brush a soapy water solution onto all joints and watch for leaks indicated by bubbles. Tighten joints if necessary and retest.

WARNING

Never use an open flame to test for gas leaks.

Check for leaks with the leak gauge each time the gas valve at the tank is opened and each day during periods of prolonged use. When testing for gas line leaks with a soapy water solution, DO NOT use a detergent containing ammonia or chlorine. These substances may generate a chemical reaction causing corrosion to gas lines, resulting in dangerous leak conditions.

8. If test still shows a leak, contact your Itasca dealer.

WINTER USE OF LP GAS

Due to vaporization characteristics of LP gas, it is important that the winter camper knows how to most efficiently use the LP system. The vaporization rate of LP gas decreases in a direct relationship to a decrease in temperature. As explained in the "Selecting Fuel Types" section, butane does not vaporize below 32° F, so propane must always be used in cold climates. However, even propane vaporizes at a slower rate as it becomes colder.

The greater the amount of liquid gas in the tank (up to the 80% level) the greater the amount of LP gas vapor generated. The following is an example of the number of BTU's available from an 84-pound tank at 0° F at three levels. As you can see, the number of BTU's decreases as the tank is emptied. Nearly twice as many BTU's are available from a full tank than one that is one-fourth full.

BTU's Available at 0° F.

<u>Tank Level</u>	<u>BTU's</u>
80%	64,400
50%	50,400
20%	33,000

The following LP Gas Vaporization and Temperature Relationship chart typifies the LP gas loss with a decrease in temperature. The percentage figures are the increase or decrease of vapor that would be available at 0° F. These figures apply to any size LP gas tank.

<u>Temperature</u>	<u>Percentage of BTU's Available at 0° F.</u>
20° F.	200%
10° F.	150%
0° F.	100%
-5° F.	75%
-10° F.	50%
-15° F.	25%
-20° F.	12 1/2%
-44° F.	Propane will not vaporize

WARNING

Make sure the filling attendant uses the 80% overflow valve when filling the tank. A tank should never be filled above the 80% level to allow for vaporization and liquid expansion.

Do not place LP gas containers inside the vehicle. LP gas containers are equipped with safety devices which relieve excessive pressure by discharging gas to the atmosphere.

Do not place LP gas containers, gasoline, or other flammable liquids inside the vehicle. Fire or explosion may result.

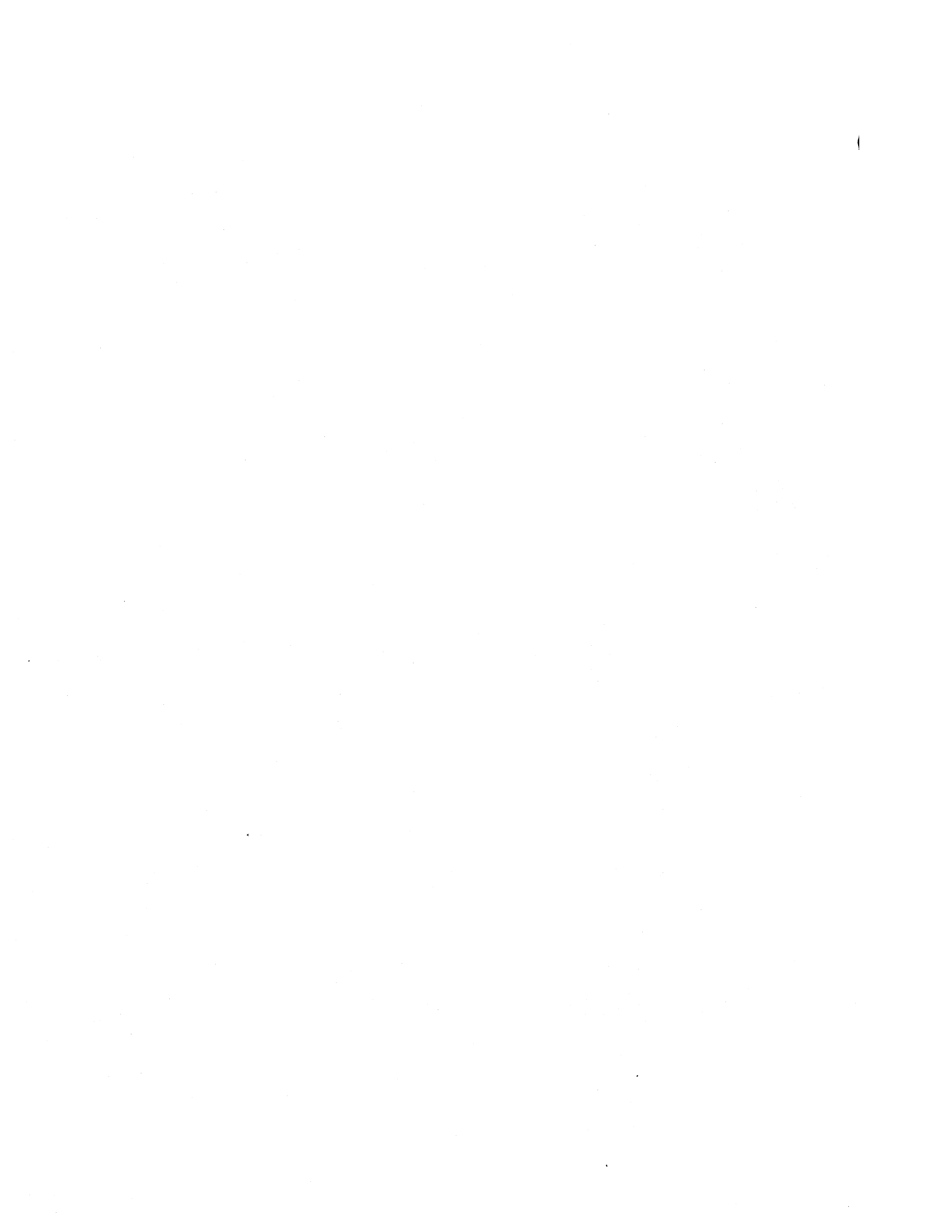

SECTION 6 ELECTRICAL SYSTEMS

(See also Safety Precautions, Section 1 of this manual.)

Your motor home is equipped with an electrical system consisting of two separate voltages; a 12-volt DC system and a 110-volt AC system. The 12-volt system consists of two internal power sources, while the 110-volt system is operated from an outside power source or the optional 110-volt generator.

110-VOLT AC SYSTEM

The 110-Volt system operates from an outside 110-volt utility service such as those at campgrounds, or from the optional 110-volt generator. When the power cord is connected to an outside power source, or when the generator is in operation, the power converter automatically changes a portion of the 110-volt current to 12-volt DC current. All equipment in the motor home that is normally powered by the auxiliary battery is then powered through the converter.

In addition, the following equipment is entirely dependent on the 110-volt generator or outside source: roof air conditioner, refrigerator (when placed in 110-volt mode), microwave oven, ice maker, vacuum cleaner and other 110-volt electrical equipment used at convenience outlets.

External Power Cord (Shoreline)

The external utility power cord (commonly referred to as a "shoreline") is stored in the sewer hose storage compartment on the left side of the motor home.

WARNING

Do not connect the external power cord to any receptacle until you have contacted the owner and/or attendant of the premises to verify proper polarity and grounding.

It is the responsibility of the owner of the electrical receptacle to ensure that the receptacle is properly wired and grounded.

Reverse polarity and improper grounding of the vehicle can cause personal injury or death.

To connect to an external power source, remove the cord from the storage compartment and plug it into a suitable power receptacle.

A small "hatch" provided in the compartment door allows the door to be closed while the cord is attached to an external source.

30 Amp Receptacle

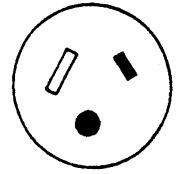

The three-prong power cord is designed to ground the electrical system through the receptacle. It is also designed to carry the amperage output of most campground outlets. If the electrical receptacle to be used is designed to mate with the three prongs on the power cord plug, the electrical connection can be expected to carry rated load.

WARNING

Do not plug the power cord into an outlet which is not grounded, or adapt the plug to connect to a receptacle for which it is not designed.

Be sure that all three prongs of the supply cord are properly plugged into the receptacle.

Do not connect the power cord to an extension cord.

Do not plug the power cord into the generator receptacle while the generator is running.

Most campgrounds are equipped with a fuse or circuit breaker at the receptacle. This protects the park's wiring, as well as the power cord on your vehicle, from electrical damage. If electrical power fails, contact the-park attendants and have them check the fuse or breaker for your supply receptacle.

After disconnecting the power cord, neatly replace it in the storage compartment.

Power Converter

The power converter changes 110-volt AC current from the auxiliary generator or the shoreline into 12-volt DC current for use by 12-volt equipment in the motor home.

Certain circuits, however, remain unchanged for use by items which require 110-volt current, such as the air conditioner(s), the refrigerator in AC mode, the microwave oven, etc.

Current drawn from the coach batteries passes through the power convertor unchanged, although it is routed through a series of protective circuit breakers.

Power Center/Converter Location (Models 28RQ, 32RA & 34RA)

In these models, the power center is located on the cabinet face below the refrigerator.

The converter power panel contains the coach electrical system 110-volt circuit breakers and the 12-volt fuses.

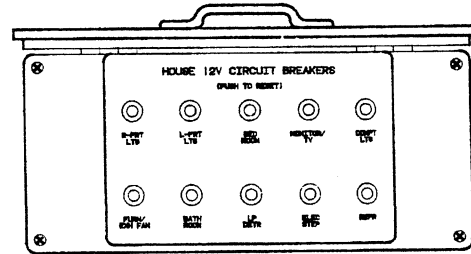

- 110-Volt Breaker Panel: in cabinet in bedroom closet.

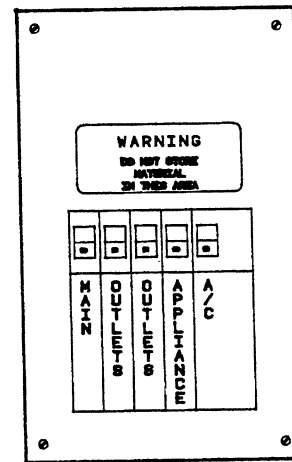
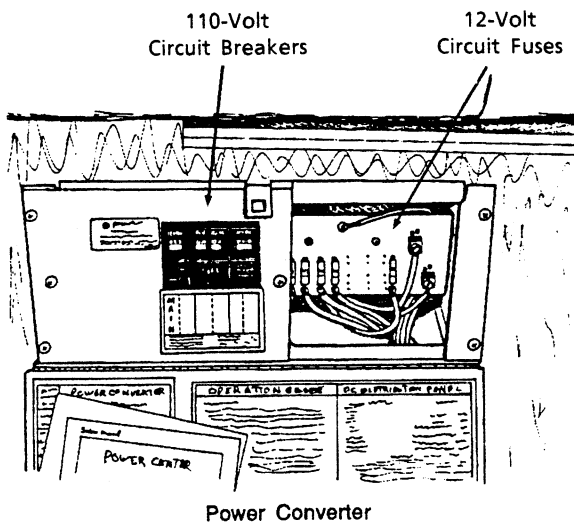

Charging Section

The converter charges coach batteries while 110-volt external power is connected. The converter will automatically "sense" the condition of the RV battery. If it is below "full charge", the Charging Section will start charging the battery.

If the coach batteries have been extremely discharged, they will accept charge at a relatively high amperage rate. If they are only slightly discharged, they will charge at a lower amperage rate. The rate of charge will decrease as the batteries reach "full charge". Active charging will not resume until batteries again fall below "full charge". The converter will not overcharge the batteries. If your storage battery does not charge as described above, it is possible the battery is defective.

Thermal Breaker

A protective thermal breaker will "break" the 110-volt AC power to the converter section of Power Center if the power converter becomes overheated. This can result from operating above its maximum limit for an extended period of time or by obstruction of ventilation to the unit.

WARNING

Do not store anything around or on top of the converter, or in front of the cover. The converter generates heat while operating, and needs unrestricted air flow for proper cooling.

Power Converter and Circuit Breaker Locations Model 40DA only

The converter system is made up of individual components located in various parts of the coach.

- Converter Unit: in basement compartment behind the rear wheels.
- 12-Volt Circuit Breaker Panel: in left side of the cabinet above toilet contains pop-out circuit breakers. Push breakers in to reset.

NOTE: Power converter section will automatically route 12-volt lights and motors to battery power in this event.

The thermal breaker will reset itself after a period of time, and the lights and motors will resume operation from power converter section. If the breaker trips again shortly after reset, take immediate steps to correct cause of overheating. A portion of RV 12-volt load (lights or motors or both) should be turned off to reduce total load. Also, inspect power converter section to make sure ventilation is not blocked.

IMPORTANT

The converter will not change 12-volt DC current to 110-volt AC.

110-Volt Circuit Breakers

The breaker panel protects all 110-volt components in the motor home from either an overload on the circuit or a short in the wiring or a component. When an overload or short develops, a breaker will stop the flow of electricity preventing any damage to the system.

Shut off the affected appliance or equipment to allow a brief cooling period. Then reset the breaker by moving the switch to "Off" and back to "On". If the breaker continually trips and no overload is evident, have the system checked for a short in the wiring or the appliances.

110-Volt Receptacles (Outlets)

A number of standard AC electrical outlets are provided throughout the coach for connecting small appliances such as televisions, radios, toasters, etc. Outlets are also located on the outside of the coach near the entrance door, or in an exterior compartment.

GROUND FAULT CIRCUIT INTERRUPTER

Exterior, bath and galley outlets are connected to a GFCI (Ground Fault Circuit Interrupter), which is an extremely sensitive circuit breaker that will help to protect against severe electrical shock if a ground fault develops. If such a condition occurs, the GFCI will break the circuit by turning off the power to the protected outlet. If this happens, unplug all the appliances on that circuit and press the reset button on the GFCI equipped outlet.

If the GFCI keeps tripping, have the electrical system checked and repaired if necessary before using again.

The GFCI outlet is located in the bath, bedroom or dinette area, depending on the floor plan of the vehicle.

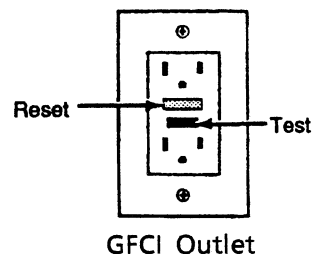

WARNING

The GFCI will not completely eliminate electrical shock. Small children and persons with heart conditions or other disabilities which make them especially sensitive to electrical shock may still be injured by a 110-volt receptacles even though protected by a Ground Fault interrupter.

NOTE: The galley outlet in Canadian equipped units is not GFCI protected.

AUXILIARY 110-VOLT GENERATOR Optional

Consult the information provided in your Owner Operation Manual binder for instructions on operation, troubleshooting and maintenance.

WARNING

Careless handling of the generator and electrical components can be fatal.

Never touch electrical leads or appliances when your hands are wet, or when standing in water or on wet ground.

Do not attempt to repair the generator yourself. Service should be performed by an authorized service center.

Do not plug the power cord into the generator receptacle while the generator is running.

To use the 110-volt generator, plug the power cord into the generator receptacle within the shoreline compartment before starting the generator.

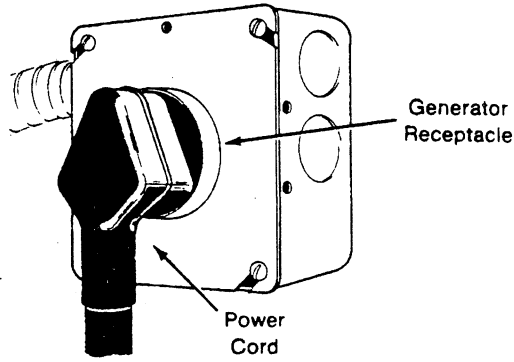

Starting the Generator

1. Turn the Auxiliary Battery Disconnect Switch on to connect power to the generator starter motor.
2. Press the generator switch (on the range hood) into the ON position and hold until the engine is running. The switch must be held in position for several seconds after the generator has started to allow the generator to reach full operating voltage.

CAUTION

Damage to the automotive alternator can occur if the 110-volt auxiliary generator is started while both batteries are connected.

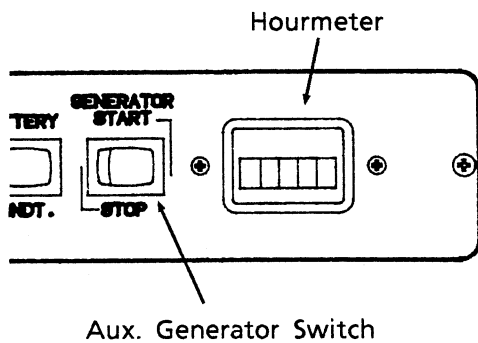

3. Allow the generator to stabilize by running 3 to 5 minutes before turning on appliances.
4. Apply electrical loads. Refer to SPECIFICATIONS section of generator manual for generator set output and performance ratings. Then refer to the chart below to aid in determining appliance usage during generator operation.

CAUTION

Continuous generator overloading can cause high operating temperatures that can damage the generator windings. Keep the electrical loads within the generator wattage rating.

APPROXIMATE POWER REQUIREMENTS OF COMMON APPLIANCES

Appliance or Tool	Approximate Running Wattage
Vacuum cleaner.....	200-500
Coffee maker.....	550-700
Hair dryer.....	800-1500
Electric iron.....	500-1200
Electric blanket.....	50-200
Television.....	60-80
Electric drill.....	250-750
Air conditioner.....	1400-2000
Converter.....	300-500
Microwave oven.....	700-1500

Stopping the Generator

1. Shut off electrical equipment to remove load. Allow generator to run for 3 to 5 minutes to cool down.
2. Press the generator switch into the OFF position and hold until the generator comes to a complete halt.

Generator Hourmeter

This meter is located on the range hood. It registers the total number of hours that the generator has been operated. Refer to the hourmeter to determine when periodic maintenance is due and to record services which have been performed.

Operation Warnings and Cautions

WARNING

The exhaust of all internal combustion engines contains carbon monoxide (CO). This poisonous gas is colorless, odorless, tasteless, and lighter than air. The exhaust systems of both your motor home engine and your generator engine have been installed with your safety in mind. However, certain precautions must be taken when using them to protect yourself from conditions beyond the control of the manufacturer.

1. Do not simultaneously operate the generator engine and a ventilator which could draw exhaust gases into the vehicle.
2. Do not open windows or ventilators on the end or side of the vehicle where exhaust pipe of the generator is located.
3. Park the vehicle so that the wind will carry the exhaust away from the vehicle. Also, note the position of other vehicles to be sure their exhaust will not enter your vehicle.
4. Do not operate the generator engine when parked if vegetation, snow, buildings, vehicles, or any other object can deflect the exhaust under or into the vehicle.

Check auxiliary generator oil level frequently during periods of use. Refer to the generator manufacturer's information in your Motor Home Operations Manual binder for specific recommendations.

WARNING

Never check generator oil level while generator engine is running.

12-VOLT DC SYSTEM

The DC voltage system consists of the automotive battery and the 12-volt motor home auxiliary batteries. The automotive battery operates the engine starter and all automotive accessories and controls found on the instrument panel. This includes the horn, speed control, all exterior lights, radio, windshield wipers, rear auto heater fan, etc.

The auxiliary batteries supply current to all 12-volt equipment located in the living area of the motor home. This includes interior lights, range exhaust fan, furnace fan, water pump, water level and holding tank gauges, 110-volt generator starter and bath roof vent fan. The auxiliary battery may also be used to start the engine if the automotive battery is discharged. Refer to "Battery Mode Switch."

12-Volt Circuit Breakers & Fuses

All 12-volt circuits and equipment in the coach area of the motor home are protected by a circuit breaker panel or fuse panel.

When a circuit is overloaded or a short develops in any part of the system, a fuse or breaker will shut down that circuit. If this happens, turn off all affected lights or appliances and reset the breaker or replace the fuse.

Fuse Panel (Models 28RQ, 32RQ, 34RA)

The fuse panel is mounted on the right-hand side of the power converter.

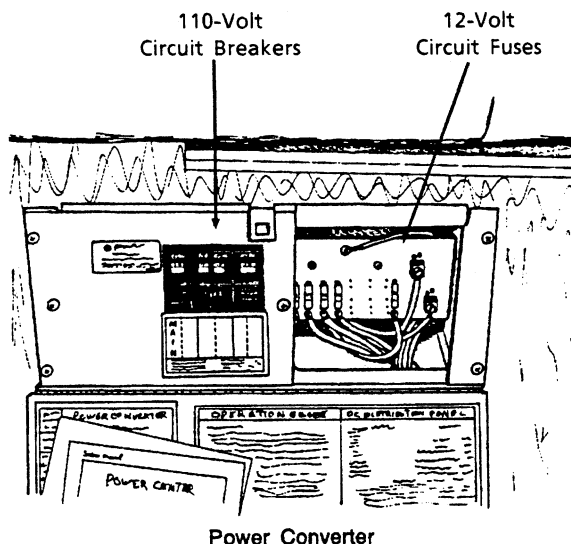

The fuse panel accepts only blade type plug-in fuses. Always replace fuses with those of the same amperage rating.

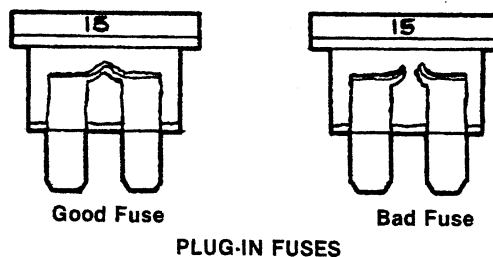

BATTERY INFORMATION

AUTOMOTIVE BATTERY ACCESS

The automotive (starting) battery for all models is located in the engine compartment.

AUXILIARY (COACH) BATTERY ACCESS

The auxiliary battery compartment is accessible from the interior of the coach. To gain access, unfasten the latch at the front of the top entrance step and open the carpeted compartment door upward.

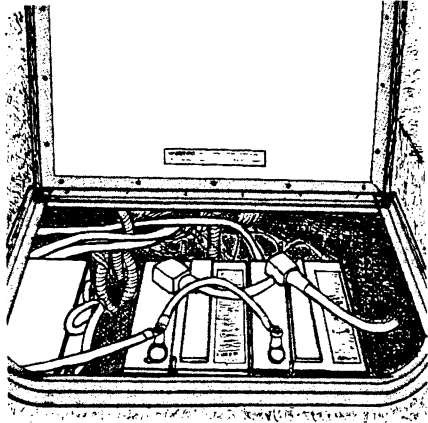

Battery Maintenance

A battery is only a storage reservoir, not a source of electricity. As soon as energy is removed from the battery, it should be replaced by the alternator or convertor system. If a battery is left discharged (dead) for longer than 30 to 90 days, it will lose its ability to hold a charge. To ensure that the battery will always accept and hold a charge, follow these simple maintenance practices.

- Make sure the batteries always remain securely clamped in the battery tray.
- Make sure battery cable clamps are tight on the terminal posts and are free of corrosion.
- Neutralize corrosion buildup or acid film on top of battery by washing with a baking soda/water solution. Rinse with clear water.

IMPORTANT

Make sure vent caps are on securely to prevent baking soda solution from entering the battery and contaminating the electrolyte fluid.

WARNING

Before removing any battery cables or battery, make sure all 12-volt equipment in the motor home is off and the power cord has been disconnected.

Always remove jewelry and wear protective clothing and eye covering when checking or handling batteries.

Be sure to replace the battery terminal boot back onto the positive terminal before sliding tray in after servicing. Care must be taken when sliding the battery tray back in, to avoid pinching the cable between the tray and the vehicle frame. Should the cable be damaged, a short could result in personal injury or damage to equipment. Replace any damaged cables at once.

Reinstall the retainer pin when returning the tray to the storage position.

- Clean and tighten battery terminals and have the specific gravity checked at least once a year.
- Every two months, or more often in hot weather, check the battery fluid level. Fill to approximately 3/8 inch above the plates. DO NOT OVERFILL. If fluid is added during freezing weather, the motor home should be driven several miles to mix water and electrolyte to prevent freezing.
- Fluid level check may be omitted if equipped with maintenance-free batteries.

WARNING

To prevent wiring damage, it is essential when replacing the cables on the battery, or when using a "booster" battery, that the positive post and the positive cable be attached and the negative post and negative cable be attached. The posts are marked (+) plus and (-) minus. If a "fast charger" is used while battery is in the motor home, disconnect both battery cables before connecting the charger. Never attempt to charge or boost a frozen battery.

BATTERY CONDITION METER

See related item under "Monitor Panel" in section 8, Appliances.

BATTERY MODE SWITCH (DUAL-MOM.)

See section 2, Driving Your Motor Home, for information on the Battery Mode Switch.

AUXILIARY BATTERY DISCONNECT SWITCH

This switch allows you to conveniently disconnect the auxiliary battery during prolonged storage periods without the need for removing a battery cable in the battery compartment. This disconnection reduces the possibility of battery drain by electrical devices (such as clocks) which are energized continuously.

The auxiliary battery switch is intended to be used to disconnect the auxiliary batteries during extended periods of non-use or for seasonal storage. It should not be used in an attempt to "save" the auxiliary batteries while using the 110-volt system.

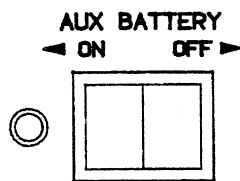

Press the switch momentarily to the ON position to connect the coach batteries. Press momentarily to the OFF position to disconnect. The switch is spring-loaded and will return to the neutral position when released.

Testing the Auxiliary Battery Disconnect Switch:

1. Turn the generator off.
2. Disconnect the shoreline.
3. Turn the ignition to the OFF position.
4. Put the Battery Mode Switch in the middle (Off) position.
5. Press the Auxiliary Battery Disconnect Switch to the ON position.
6. Turn on an overhead light. If the light works, the Auxiliary Battery is connected.

NOTE: If the overhead light does not work, the Auxiliary Battery needs charging. Read the following section for instructions.

CAUTION

NEVER disconnect the auxiliary batteries while the utility power cord ("shoreline") is plugged into either the generator or an external receptacle. Electronically sensitive equipment, such as TV's and VCR's or high amperage equipment, such as the electric step, may be damaged if operated while auxiliary batteries are disconnected.

IF THE AUXILIARY BATTERIES BECOME DRAINED

Since the auxiliary battery switch is powered by the auxiliary batteries, the switch cannot be turned on if auxiliary battery voltage is less than 7.5 volts. It is possible to "jump start" the switch using the main battery to operate the switch and reconnect the auxiliary batteries. Described below is the procedure you should follow in this event.

1. Turn ignition key on.
2. Place the Battery Mode Switch in the Dual position.
3. Press the Auxiliary Battery Disconnect Switch to the ON position and release.
4. Start the engine to provide alternator charging.

NOTE: This procedure is necessary only if the auxiliary batteries are extremely discharged. If the auxiliary batteries fail to reconnect, check the 5A fuses on the top of the relay and replace with 5A fuses if necessary. If the fuses are okay, another problem may exist. Check your dealer for assistance.

SECTION 7 PLUMBING SYSTEMS

FRESH WATER SYSTEM

The fresh water system provides water to the galley sink, shower, bathroom lavatory, toilet and water heater. Water may be supplied by either of two sources:

- a water tank located within the motor home, or
- any external water source to which the motor home may be connected, known as "city water".

FRESH WATER TANK FILLING PROCEDURES:

Always fill the fresh water tank at an approved potable water filling facility or a known purified drinking water source.

Be sure all water system drain valves are closed before filling the tank. See drain valve locations on page 7-5.

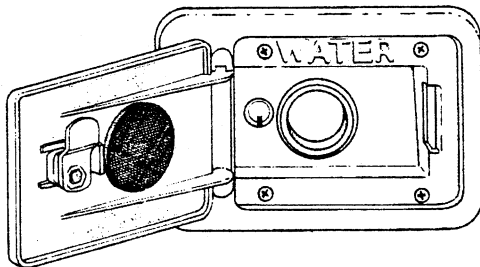

Water Tank Fill

Filling the Tank - Models 28RQ, 32RQ and 40DA

The tank may be filled by inserting a hose into the tank fill opening. A built-in vent prevents the tank from becoming air-locked while filling.

When neither city water nor a hydrant are available, a bucket and funnel may be used to fill the tank, but this can take a considerable amount of time.

Filling The Tank - Model 34RA (40DA alternate method)

Your coach is equipped with a convenient Water System Compartment. This compartment combines the tank fill and city water hook-up in a single location. To accomplish this, these models were designed with a pressure-fillable water tank. This means that water line pressure is used to force water into the tank. This unique type of system requires a different technique for filling and adding solutions to the tank than other RV water systems.

1. Be sure the water pump switch (inside the coach) is OFF.
2. Be sure all faucets are CLOSED.
3. Attach a water hose to the city water connector.
4. Turn the outside water supply ON.
5. Turn the tank fill valve ON. The tank is full when water runs out of the overflow tube beneath the vehicle.
6. Turn the tank fill valve OFF.
7. Turn the outside water supply OFF. Then disconnect the hose.

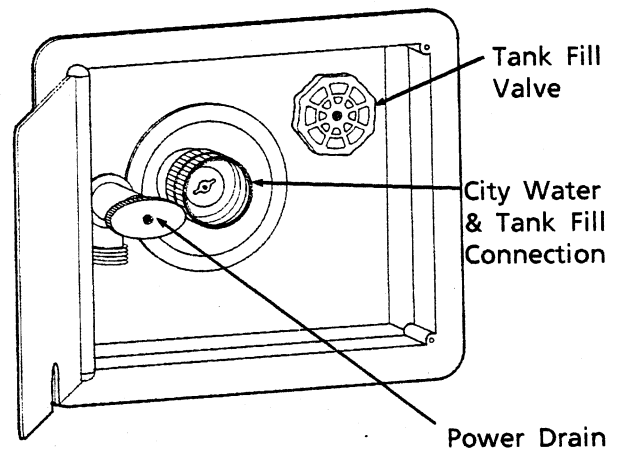

NOTE: Always keep the tank fill valve closed unless you are filling the tank. If this valve is open while using the city water, the water will continuously flow into the tank and out the overflow tube.

Although the fresh water system is installed primarily below the floor of the vehicle, the tank and water lines are insulated to provide cold weather protection. A furnace duct routed to the water tank compartment supplements this thermal protection, allowing operation at temperatures to below 32°F. Operation at subfreezing temperatures is dependent upon individual weather conditions and duration of exposure to those conditions.

Fresh Water Tank Capacity	
Model 28RQ	44 gal.
Model 32RQ	60 gal.
Model 34RA	60 gal.
Model 40DA	60 gal.

Draining the Tank

The quickest and easiest way to drain the tank is to use the power drain faucet. To do this, turn the coach water pump ON and open the power drain valve.

When draining the entire water system for winter storage, open the water heater drain and water system drain valves along with the power drain. This allows complete drainage of all water lines as well as the tank.

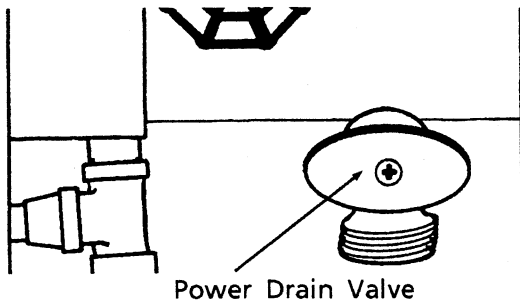

Water Pump

Pressure for the water system is supplied by a water system demand pump which is fully automatic after initial priming. When a faucet is opened, the pump automatically provides a constant flow from the tank. When the faucet is closed, the pump automatically shuts off.

Water Pump Switch

The water pump switch is located on the water/holding tank monitor panel (See Section 8). For your convenience, a second switch is also located in the bathroom area.

While the switch is "ON", the pump will automatically supply water pressure as it is needed.

We recommend that you turn the pump switch off whenever you are away from the vehicle or not using the water system. A slow leak in a faucet could drain the water system and discharge the coach battery.

Initial Start-Up

1. Make sure that all water drain valves are closed, including water heater valve. (Refer to Section 11.)
2. Turn water pump switch to "OFF" position.
3. Fill water tank.
4. Open all faucets, hot and cold.
5. Turn on pump switch.
6. Close each faucet as it begins to deliver a steady stream of water (close cold water

first). Leave hot water faucets on until they also deliver a steady stream of water. This will ensure that the water heater is filled with water.

7. Check to be sure pump stops soon after all faucets have been closed.
8. Pump is now ready for automatic operation. Pump will start when a faucet is opened and stop when the faucet is closed.

Special Instructions for Pressure-Fill Water Systems

Sanitizing the Tank (Model 34RA only) (Adding Chlorine Solutions)

WARNING

Chlorine is poisonous. Recap bottle and clean utensils after use.

We recommend using a small pump that attaches to a common garden hose to force sanitizing solutions into the tank. These pumps are available as inexpensive hand-powered or drill-powered units and may be obtained at hardware or automotive supply stores.

If you do not have a pump, you can fill the tank with sanitizing solution or RV antifreeze by the following method.

1. Attach a hose to the city water connector on the coach.
2. Fill the hose with the required solution.
3. Connect the other end of the hose to an external water supply.
4. Turn the water on to let water pressure force the solution from the hose into the tank.
5. Repeat steps 1-4 until you have added the necessary amount of solution.

When sanitizing the water tank, follow the complete disinfection instructions listed below.

INSTRUCTIONS FOR DISINFECTION OF FRESH WATER SYSTEMS ON RECREATION VEHICLES

(As approved by the U.S. Public Health Service)

To assure complete disinfection of your fresh water system, it is recommended that the following procedure be followed on a new system, one that has not been used for a period of time, or one that may have become contaminated. This procedure is also recommended before long periods of storage such as over winter.

1. Prepare a chlorine solution using 1 gallon of water and 1/4 cup of household bleach (sodium hypochlorite solution). With tank empty, add chlorine solution to the tank. Use 1 gallon solution for each 15 gallons of tank capacity. This procedure will result in a residual chlorine concentration of 50 ppm in the water system. If a 100 ppm concentration is required as discussed in item 3, use 1/2 cup of household bleach with 1 gallon of water to prepare the chlorine solution. One gallon of the solution should be used for each 15 gallons of tank capacity.
2. Complete filling of tank with fresh water. Open each faucet and run the water until a distinct odor of chlorine can be detected in the water discharged. Do not forget the hot water taps.
3. Allow the system to stand at least 4 hours when disinfecting with 50 ppm residual chlorine. If a shorter time period is desired, then a 100 ppm chlorine concentration should be permitted to stand in the system for at least 1 hour.
4. Drain and flush with fresh water.

WARNING

Chlorine is poisonous. Recap bottle and clean utensils after use.

EXTERNAL WATER SUPPLY ("City Water")

To connect to an external source:

1. Turn the demand pump switch to OFF. (Models 34RA & 40DA, also be sure tank fill valve is closed.)
2. Attach a hose from the external water source to the city water connection on the left side of your vehicle.
3. Turn on the external water source.

City Water
Connection

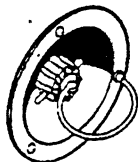

When connected to an outside source of water, the water bypasses the demand pump and storage tank and supplies pressure directly to individual faucets and toilet. A check valve built into the pump prevents water from entering the pump and filling the storage tank.

To disconnect from the external source:

1. Turn the external source off.
2. Open a faucet inside the vehicle to relieve line pressure.
3. Disconnect the hose from the vehicle and replace the cap on the connection.

Flushing the City Water Connector

The city water connector should be "back-flushed" periodically to avoid leakage or premature failure of the check valve assembly. Back-flushing the check valve will dislodge foreign particles and moisten the rubber plunger seal, allowing the valve to properly seat and form a complete seal.

To do this:

1. Attach a water hose to the city water connector and pressurize the vehicle's plumbing system by filling the lines with water.
2. After the lines are full, disconnect the water hose from the city water connector.
3. Remove the screened washer from the hose coupler on the city water connector.
4. Step aside of the city water connector to avoid getting wet. Then depress the plunger inside the check valve to allow water to flow back out ("back-flush") through the check valve.

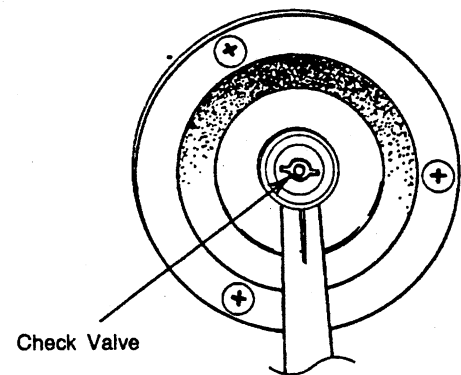

5. Repeat the previous steps as needed to ensure complete removal of any debris present inside the check valve assembly.

Do this procedure several times each season during use to keep the check valve operating properly.

SHOWER HOSE VACUUM BREAKER

After using the shower, you may notice water dripping from the shower faucet assembly. The

dripping results when vacuum in the shower hose (after closing the shower faucet) slowly releases and allows water remaining in the hose to drain down. This is a normal function of the shower valve assembly and is not a leak or defect.

The International Association of Plumbing and Mechanical Officials Standard TSC 21-85 (PAR. 4.3) states:

"Shower heads which incorporate shutoff valves, shall have a minimum "drip rate" of one (1) quart in thirty (30) minutes."

CAUTION

If items are placed into the shower tub before shower valve vacuum release is complete, they may become wet.

The label shown below is attached on or near the faucet to explain the operation of the vacuum breaker assembly.

For your protection, this faucet is equipped with a vacuum breaker (back flow preventer) to prevent contamination of your potable water supply. The water in the hand held shower hose will drain through this vacuum breaker when the faucet is turned off. This is not a leak. This drainage is inherent in the design of the vacuum breaker, and is evidence that it is functioning properly.

P.P.I. 0387

DRAINAGE SYSTEM

The drainage system is self-contained, allowing use of the toilet, sinks, or shower even in areas where sewage hook-up is not available. The drainage system may have two or three holding tanks depending on model and floor plan.

The holding tanks are dumped through a common outlet.

The sewage dump valves and outlet are located inside a compartment at the rear driver side of the vehicle. The sewage hose may be routed through a passage in the floor of the compartment, allowing the door to be closed while attached to an on-site disposal. The hose may also be stowed within the compartment when not in use.

DUMPING HOLDING TANKS

1. Remove drain hose from storage compartment.
2. Remove dust cap from drain and connect drain hose. Be sure it is firmly attached. The dump outlet swivels up and down as shown for hose attachment and drain positioning.

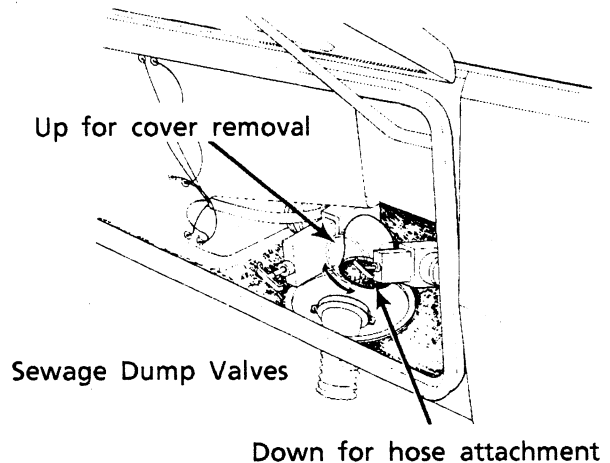

3. Place the other end of sewer hose into disposal opening.
4. Open the sewage valve with a quick pull. OPEN ONE VALVE AT A TIME. Move hose gently about to dislodge any waste and to ensure complete drainage.

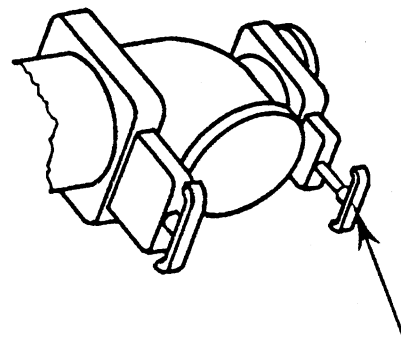
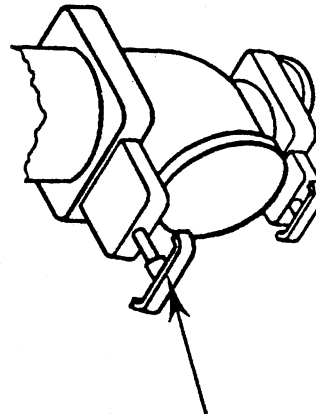

5. Close sewage valve and open waste water valve with a quick pull. Make sure there are no sags in the hose during drainage. Close valve handle as soon as tank is empty.

6. After both tanks have been drained, run several gallons of water into the sewage tank through the toilet. Then open sewage dump valve and drain the tank again. Close valve and securely replace dust cap.
7. It is advisable to add an odor control chemical to the sewage holding tank. These chemicals are available at most R.V. stores.
8. Rinse sewer hose thoroughly with water and stow.

NOTE: We recommend that you dump all holding tanks before traveling to avoid carrying unnecessary weight.

USING ON-SITE SEWER HOOK-UPS

The drain hose may remain attached to the dump outlet and be routed out the bottom of the compartment while the motor home is parked and connected to an on-site sewage hook-up.

When using a sewer hook-up, keep the dump valves closed until a tank becomes full or when preparing to leave the site. This keeps the solids in suspension, allowing them to be carried out with the liquids when the dump valve is opened. If the

valve is left open, the liquids will drain off, leaving solids in the tank. Should this accidentally happen, disconnect the hose, fill the tank about half full with water, and drive a few miles to dislodge the solids. A few starts and stops will aid in the process. Then reconnect the hose and drain in the normal manner.

HOLDING TANK LEVEL INDICATORS

The holding tanks may be monitored on the wall mounted monitor center. model and options.

Press the "Levels Test" switch to check the level in each tank.

See page 8-5 for further information on the monitor panel.

WATER DRAIN VALVES

The water drain valves are used to drain water from the water tank and the water supply lines when preparing the motor home for storage or when sanitizing the water system.

To open the valves, simply pull the rings upward approximately 1/2". To close, push the valve shafts downward until they are fully seated.

HOLDING TANK CAPACITIES		
Model	Tank 1 (Toilet/Lav.)	Tank 2 (Galley/Shower)
28RQ	24 gal.	35 gal.
40DA	49 gal.	52 gal.
	(Toilet)	(Lav./Galley/Shower)
32RQ	22 gal.	59 gal.
34RA	24 gal.	53 gal.

WATER SYSTEM DRAIN VALVE LOCATIONS

MODEL	DRAIN VALVE LOCATIONS
28RQ	In-line both sides demand pump (above LP tank in sub-floor); galley cabinet under stove. Power drain faucet in sewage drain compartment.
32RQ	Rear luggage compartment both sides. Power drain faucet in sewage drain compartment.
34RA	Second luggage compartment from rear on passenger's side; behind water heater, access through luggage compartment passenger's side. Power drain faucet in fresh water compartment.
40DA	Behind drawer below oven; sewage compartment (driver's side). Power drain faucet in fresh water compartment.

SECTION 8 APPLIANCES

(See also Safety Precautions, Section 1 of this manual.)

IMPORTANT

Some items described in this section may be optional and, therefore, may not be in your vehicle.

The appliances installed in your motor home are manufactured by reputable RV appliance makers and have been tested by independent laboratories to meet all applicable standards and codes set for RV appliances. These appliances are covered by your New Vehicle Limited Warranty. (Certain items may be covered by individual manufacturer's warranty.) See your New Vehicle Limited Warranty for details.

REFRIGERATOR

The refrigerator in your coach can be operated from either of two power sources available to the motor home:

- 110-Volt AC electric
- LP gas

This allows you to keep your perishable foods cold in any location, and while traveling.

The refrigerator is an absorption type which uses an ammonia-water solution for cooling. Basically, ammonia vapor is distilled from the solution by heat, produced from either LP gas or electricity and then carried to the finned condenser where it liquifies. The liquid then flows to an evaporator where it creates cold temperatures through evaporation.

Leveling

Before operating the refrigerator when the motor home is stationary, place a small level on the freezer plate and make certain the unit is level.

CAUTION

To obtain proper performance from the refrigerator and prevent damage to the cooling unit, make certain the motor home is level side to side and front to rear when parked. When the motor home is in motion, the continuous movement will not affect the refrigerator since the rolling and pitching action will prevent pockets of liquid from forming. If the motor home is parked in an out-of-level position for more than one hour, the refrigerator must be turned off.

Normal vehicle leveling to provide comfort for the occupants is satisfactory for refrigerator operation. This will be well within the operation limits of 3° off-level side to side and 6° off-level front to back.

Operation While Traveling

While the refrigerator should be level when the vehicle is stopped, performance while traveling is not normally affected.

OPERATING INSTRUCTIONS

Norcold Models 662 and 682 with Auto Mode Selector

Start-Up Instructions - Auto Mode

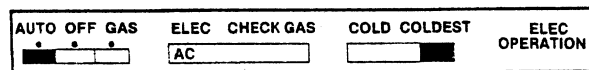

1. Move thermostat to COLDEST position. Set AUTO-OFF-GAS switch to AUTO.
2. If 110 volts is active, the panel will display AC, indicating refrigerator is operating in 110 volt AC mode.
3. If 110 volts AC is inactive (power failure, disconnected, etc.), it will display LP, indicating refrigerator has automatically switched to LP gas mode.
4. If the panel displays LP and a red X continuously, the refrigerator has failed to ignite burner on gas mode. Restart gas operation by moving AUTO-OFF-GAS switch to OFF and back to AUTO. (See steps 3, 4, and 5 under Gas Mode). NOTE: Unit operation will automatically return to AC when 110 volts AC is restored, even if the unit is locked out on gas operation.
5. Move thermostat to desired setting, usually a middle setting.

Start-Up Instructions - Gas Mode

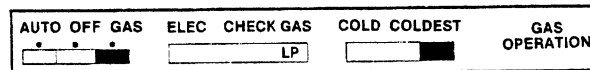

1. Move thermostat to COLDEST position, Set AUTO-OFF-GAS switch to GAS.
2. The panel will display LP, indicating LP gas mode. (If LP is not displayed, check for loss of DC supply voltage.) Initially, the red X will be displayed for about 5 seconds; after which, sparking will start at the burner and the red X goes off.

3. After 10 seconds, the burner should ignite and operate normally.
4. On the initial refrigerator start-up, it may take longer than 10 seconds to allow air to be purged from the gas line. If gas does not ignite within 10 seconds, valve will automatically shut off and the red X will be displayed at the CHECK position.
5. To restart when the X is displayed, move AUTO-OFF-GAS switch to OFF position, then return switch to the GAS position.
DO NOT CONTINUE TO RESET GAS SWITCH IF THE CHECK INDICATION CONTINUES TO DISPLAY AFTER SEVERAL TRIES.

Shut Down Instructions - Gas or Electric

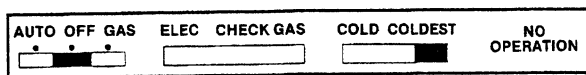

Short Duration: Set AUTO-OFF-GAS switch to OFF.
Long Duration: Set NORMAL-STORAGE-HIGH HUMIDITY switch (located on divider between the two doors) to STORAGE.

Location of Controls

The Mode Selector is located above the upper door and includes the thermostat for controlling the interior temperatures, the switches which select the operating mode, and the panel which continuously displays the selected operating mode. On the divider panel, located between the two doors, is the High Humidity and Storage switch. (See following paragraphs for a description.) The light switch is located in this area to automatically activate the cabinet light when the lower door opens.

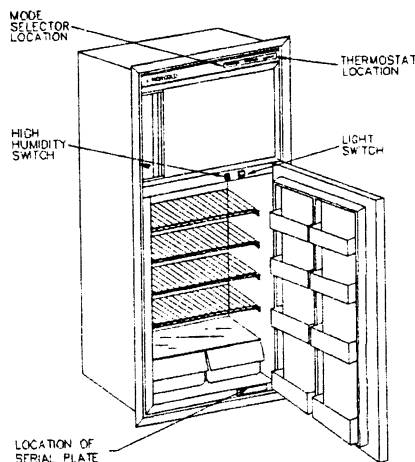

Mode Selector

AUTO:

The refrigerator will operate on 110 volts AC so long as AC power is available to the refrigerator. If AC power is lost (or disconnected), the Selector will automatically switch to gas operation. As soon as AC power is restored, the Selector automatically switches back to AC operation. (The user does not have to manually switch the refrigerator back to AC.) When the operation is automatically switched to gas, the burner will ignite and continue to operate the refrigerator at the same thermostat setting as set for AC power. The gas operation assumes that an LP gas and 12-volt DC supplies are available.

GAS:

This selection allows the refrigerator to operate on LP gas only. It will not automatically switch modes regardless of whether AC power is connected or not. If the flame is lost (LP tank empty, etc.), the operation locks out and must be manually reset.

ICE MAKER

Some Norcold refrigerators are optionally equipped with an automatic ice maker*system. The ice maker unit is installed in the freezer compartment of the refrigerator.

The ice maker does not freeze the ice. The refrigerator freezer compartment does the actual freezing of the water. The ice maker simply senses when the ice is ready, ejects it into the ice bin, and refills the molds with water for another ice cycle. When the ice bin is full, the amount of ice will raise an automatic shutoff arm which stops the ice maker. Some problems involving lack of ice production - particularly a lack of freezing - may be the fault of the refrigerator rather than the ice maker.

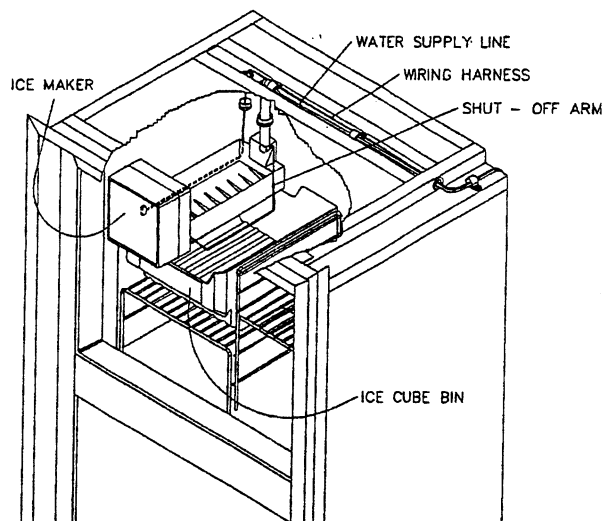

Ice Maker Location - Freezer Compartment

OPERATING THE ICE MAKER

1. Connect the coach shoreline to a 110VAC source and switch the refrigerator to AUTO (AC electric) mode. The ice maker motor runs on 110-volt current only.
2. Connect the coach to an external (city water) source or leave water pump switch on continuously to provide a constant water supply.
3. Be sure the ice bin is in place and the ice maker's automatic shut-off arm (wire) is in the down (automatic) position. If the arm is up, the ice maker will not operate.

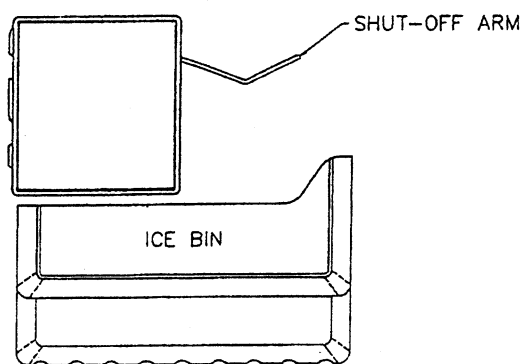

MANUAL OFF POSITION

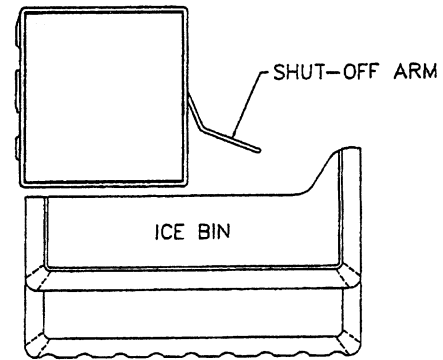

AUTOMATIC ON POSITION

4. Start the refrigerator the day before ice cubes are needed. When the refrigerator is started (from room temperature), it is normal to take as long as 24 hours to become cold enough to make the first batch of ice cubes.
5. Always discard the first batch of cubes made in a new ice maker. The new plumbing lines and connections may cause discolored and bad tasting ice.
 - * The ice maker will make up to 3 lbs. of ice in 24 hours, if the freezer temperature is 14°F or below.
6. To remove the ice bin, raise the automatic shut-off arm (off). When returning the ice bin to the freezer, remember to lower the shut-off arm (on). If the arm is up, the ice maker will not operate.

SHUT-DOWN

To turn the ice maker off, simply raise the shutoff arm.

WINTERIZING

When winterizing, make sure the water line is completely drained by following this procedure.

1. Shut off the water supply.
2. Drain the water supply line to the refrigerator, and at the refrigerator drain valve.
3. Let the ice maker run through a cycle, then move the shut-off arm up to the manual/off position.
4. Drain water again at the refrigerator drain valve.

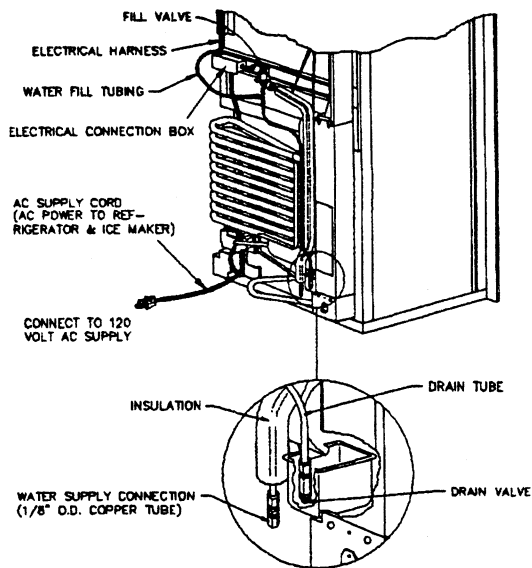

Start-Up (Removing from Storage)

1. Close all drain valves.
2. Turn the water supply on.
3. Be sure the ice bin is in place and the automatic shutoff arm is down.
4. Let the refrigerator cool down to ice making temperature. Remember, this can take up to 24 hours.
5. Let the ice maker cycle and dump the first batch of ice.

Troubleshooting The Ice Maker

1. **Is 110-Volt AC reaching the refrigerator?**
 - A. Ice maker motor needs 110VAC to operate.
 - B. Be sure refrigerator power cord is plugged in.
 - C. Check appropriate breaker on 110 VAC breaker panel.
2. **Is 12-Volt DC reaching the refrigerator?**
 - A. Refrigerator eyebrow control and power supply board both need 12VDC to operate.
 - B. Check 12V fuse or breaker on converter panel.
3. **Is water supply pressure at least 15 psi, but no more than 125 psi?**
 - A. If not enough, turn city water faucet open further or check for blockage.
 - B. If too much, attach water pressure regulator.
4. **Is the water supply inlet valve on?**
 - A. Check inlet valve on back side of refrigerator.

5. **Is the freezer compartment temperature 14°F or lower?**
 - A. Turn refrigerator temperature control to colder setting, if needed.
6. **Is the ice maker's automatic shut-off arm in the down (on) position?**
 - A. If arm is not down, ice maker will not operate.
7. **Has it been at least 24 hours since the refrigerator was turned on?**
 - A. If not, allow more time.
 - B. If so, refer to your dealer or a Norcold service center.
8. **Water not filling molds:**
 - A. Water inlet valve off (on back side of refrigerator)
 - B. Insufficient water pressure
 - C. Water line blockage
 - D. Faulty water solenoid - stuck off
9. **Water over-filling molds:**
 - A. Excessive water pressure
 - B. Faulty water solenoid - stuck on
10. **Water not freezing:**
 - A. Refrigerator problem.
11. **Ice not ejecting:**
 - A. 110VAC power not connected
 - B. Mold heater not working - replace ice maker
 - C. Ejector motor not working - replace ice maker
12. **Ice bin overfilling:**
 - A. Shutoff switch broken
 - B. Shutoff wire stuck
13. **Low ice production:**
 - A. Water not freezing fast enough - refrigerator problem
14. **Freezer needs defrosting often:**
 - A. Ice maker motor and mold heater add heat to compartment, which develops frost. This is normal.
 - B. Check door gasket for proper sealing.

Quick Reference:

For Gas Operation:

- Propane gas must be available.
- 12 Volts DC
- NOTE: 12 volts is necessary to automatically light or relight gas burner.
- Controls set per "Lighting Instructions."

For AC Operation:

- 110 Volts AC (108 volts minimum).
- Controls set per "Start-Up Instructions."

Humidity - Storage Switch

Turning this switch to HIGH HUMIDITY will keep the surface between the door openings dry during high humidity conditions. The switch should be left in the NORMAL OPERATION position unless moisture collects around the door.

When storing your RV for the winter, place this switch in the STORAGE (LIGHT OFF) position. This shuts off all DC power to the light and humidity heater and allows the refrigerator door to be left open for airing without draining the battery.

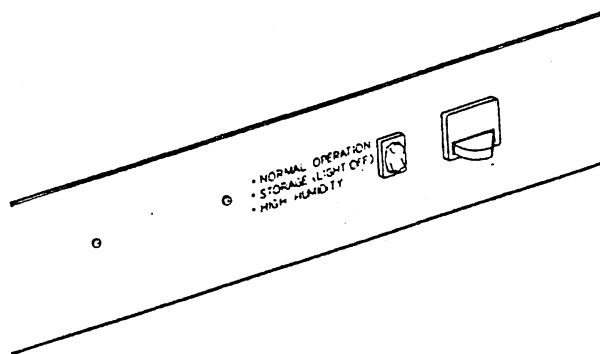

REFRIGERATOR COMPARTMENT (Exterior)

The exterior refrigerator compartment allows access to the rear of the refrigerator for inspection, maintenance and service. The LP gas Leak Gauge is also located in this compartment. (See LP LEAK GAUGE, Section 5.)

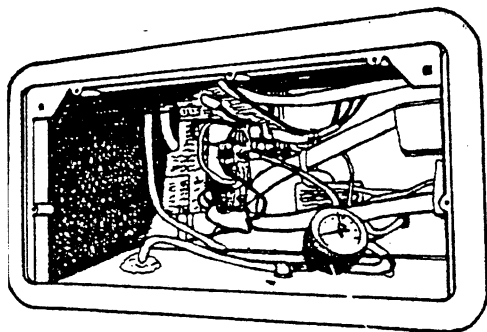

Refrigerator Access Compartment

To Open:

1. Turn the latch knobs to the left 1/4 turn to the vertical position as shown.
2. Remove the door from the opening.

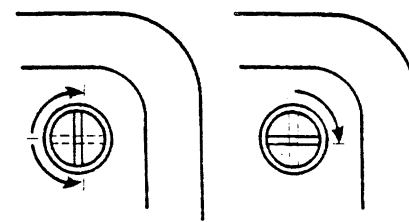

OPEN

CLOSE

Refrigerator Access Door Latches

To Close:

1. Replace the door into the opening.
2. Push the latch knobs in while turning to the right 1/4 turn to the horizontal position as shown.

RANGE AND OVEN

The range and oven in your motor home are operated on LP gas and will provide nearly all of the functions that the range in your home does. One benefit of gas burners is that heat is available as soon as a burner is lit, as opposed to an electric element slowly heating up. The range has a "Pilot Off" position on the oven control which allows the oven pilot to be turned off when traveling or refilling the LP tank.

The following warning label has been located in the cooking area to remind you to provide an adequate supply of fresh air for combustion.

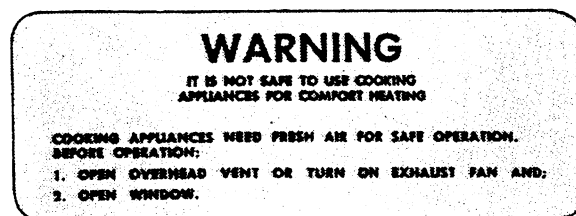

Unlike large homes, the oxygen supply inside a recreational vehicle is limited due to its size. To avoid danger of asphyxiation, provide proper ventilation when using the gas rangetop or gas oven. It is especially important not to use the gas oven and range top for comfort heating. Danger of asphyxiation is greater when these appliances are used for long periods of time.

WARNING

Portable fuel-burning equipment, including wood and charcoal grills and stoves, shall not be used inside the recreational vehicle. The use of this equipment inside the recreational vehicle may cause fires or asphyxiation.

Lighting Top Burner Pilot (If Equipped)

NOTE: If the range has not been used for a long period of time, it may take longer to light the pilot because of air in the gas line.

NOTE: Before turning the main gas supply (tank) valve on, be sure all top burner controls and pilot shut off valve are in the OFF position.

1. Turn on main gas supply to range.
2. Lift burner top panel and turn pilot shut off valve to ON position (handle parallel to gas line) as shown.

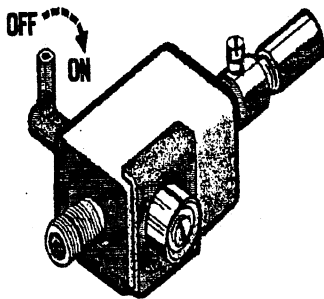

Pilot Shut Off Valve

3. Touch lighted match to pilot.

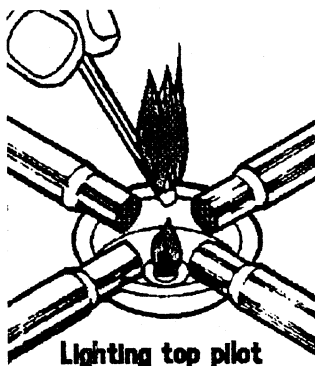

Lighting top pilot

Using the Top Burners (with Pilot)

1. Turn the control knob left (counterclockwise) to the full ON position.
2. Adjust the flame height by turning the knob back toward the OFF position.

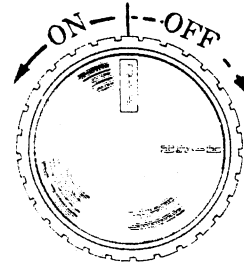

Use of Top Burners (without Pilot)

1. Light match.
2. Apply lighted match to burner.
3. Turn control knob left (counterclockwise to the full "On" position).
4. Adjust the flame height by turning the knob toward the "OFF" position.

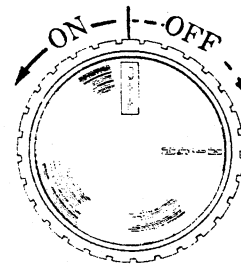

WARNING

Do not turn burner control knob to "On" and allow gas to escape before lighting match.

Shut Down Instructions

When top burner cooking is finished, turn the top control knob(s) to the OFF position. The top burner pilot (if equipped) will remain lit.

When the recreational vehicle is not in use, or while traveling, lift the main top panel and turn the pilot shut off valve to the OFF position and turn off main gas supply (tank) valve.

LIGHTING OVEN PILOT

NOTE: If range has not been operated for a long period of time, a longer waiting period for ignition of the pilot may be necessary due to air in the gas line.

1. Be sure all valves are in the "OFF" Position. The oven control knob should be in "OFF" position.
2. Turn on main gas supply to range.
3. Depress and turn control knob to the "OVEN PILOT ON" position. This will allow gas to oven pilot.
4. Open oven door and light oven pilot with a match. Small flame will be noted at the top of the pilot burner.

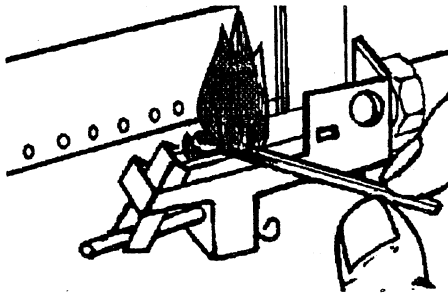
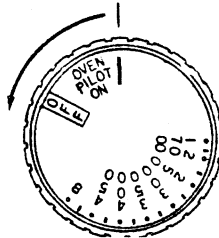
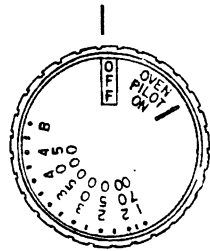

Lighting oven pilot (When pilot is located on left side of burner.)

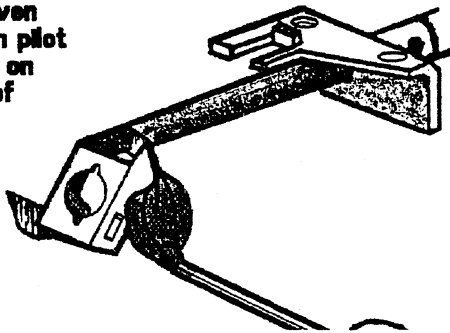

Operating the Oven Control

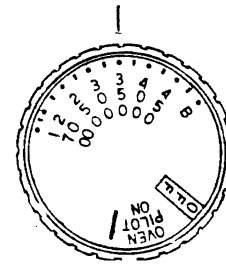

Depress and turn the oven control knob (counterclockwise) to the desired temperature setting. There is a delay of about 45 seconds before the main burner ignites. This is normal and there is no gas escaping during this delay. It is also normal for the oven burner flame to cycle off and on at all temperatures except broil.

Shut Down Instructions

When oven cooking is finished, turn the oven control knob to the "OVEN PILOT ON" position, the oven standby pilot will remain lit.

When the recreational vehicle is not in use or while traveling, turn the oven control knob to "OFF" position and turn off main gas supply; this will turn off the oven pilot.

MICROWAVE OVEN (Optional)

For complete operating instructions, refer to the manufacturer's information provided with the oven.

RANGE HOOD/MONITOR PANEL

The range hood vent allows you to exhaust cooking odors and gas fumes to the outside of the coach and to supplement fresh air ventilation. A light on the underside of the hood provides better illumination for food preparation.

The monitor panel is built into the face of the range hood. It provides central location of switches for the hood fan, hood light, water pump and tank level indicator lights.

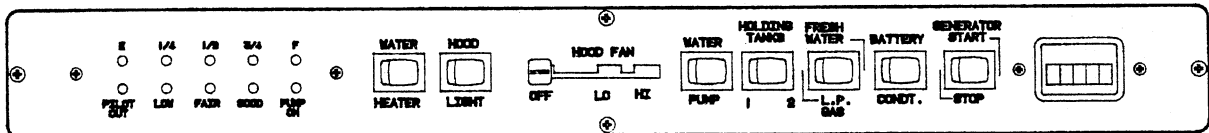

Monitor Panel - Models 28RQ, 32RQ, & 34RA

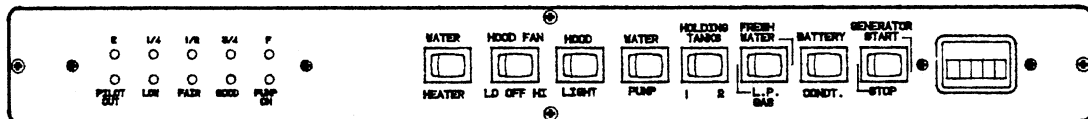

Monitor Panel - Model 40DA only

The auxiliary electric generator start/stop switch and hourmeter are also located on the panel. See section 6 for generator starting and stopping instructions and operating precautions.

Hood Fan and Light Switches

To turn on the range hood light, simply press the switch labeled "Hood Light". To operate the range hood fan, push the "Hood Fan" switch toward "High" or "Low" depending on the volume of exhaust desired.

Generator Start/Stop Switch

See section 6, Electrical Systems for generator start-up and shut-down instructions.

Generator Hourmeter

See section 6, Electrical Systems for generator hourmeter information.

Water and Holding Tank Levels

Press and hold the desired tank level switch to show approximate level on the monitor lights.

These approximate water levels are measured by electronic probes in the sides of the tanks, so the water must be touching a probe to register at that level. There is generally more water in a tank than indicated on the monitor panel.

For example, if the water is just 1/2" below the FULL probe, the monitor will show the level to be only 3/4 even though the tank is nearly full. If the water level is below the 1/4 probe, the monitor will register an empty tank because the water is no longer touching the 1/4 probe. There may actually be some water left in the tank. However, when the indicator reads FULL, the tank is actually full.

Fresh Water Tank Capacity:		
Model 28RQ		44 gal.
Model 32RQ		60 gal.
Model 34RA		60 gal.
Model 40DA		60 gal.
Holding Tank Capacities:		
Model	Tank 1 (Toilet/Lav.)	Tank 2 (Galley/Shower)
28RQ	24 gal.	35 gal.
40DA	49 gal.	52 gal.
	(Toilet)	(Lav./Galley/Shower)
32RQ	22 gal.	59 gal.
34RA	24 gal.	53 gal.

LP Gas Level

Press and hold the "L.P. Gas" switch to show approximate LP tank level.

The LP level is registered by a sending unit on the tank. The gauge mounted on the side of the tank will give a more accurate indication of actual tank level if needed.

Water Pump Switch

When use of the self-contained water system is desired, turn the "Water Pump" switch on. The "Pump On" light will illuminate when the pump switch is on and the system is operable. Water will be available as soon as a faucet is opened. Refer to "Fresh Water System" for additional information on the water pump and initial start-up.

Battery Condition Meter

Push the "Battery Cond." switch button to check the level of charge (voltage) in the 12-volt coach battery. The indicator at the left side of the panel will light up to the amount of charge the battery contains.

- * Good - good or adequate charge.
- * Fair - marginal charge.
- * Low - battery needs charging before use.

To get an accurate reading;

1. The battery mode switch must be in the neutral (middle) position.
2. Both the chassis engine and the auxiliary generator engine must be shut off.
3. An interior light should be turned on to provide a small load which draws off the battery surface charge.

WATER HEATER

Direct Ignition Models G6A-6E, GH6-6E, and GCH6-6E

1. Place Water Heater switch in the "On" position. The switch and "Pilot Out" light are located on monitor panel.
2. If "Pilot Out" light stays on longer than 15 seconds, place switch in "Off" position and wait 5 minutes.
3. Repeat step one.
4. If heater fails to operate due to high water temperature, the heater will go into a lockout condition ("Pilot Out" light on). When water cools, reset by placing switch in "Off" position for at least 30 seconds, then return to "On" position.
5. If a lockout condition persists: contact your dealer, an Atwood Service Station or Atwood Service Department (Phone: 815-877-7461).

6. For complete shut-down before servicing:
 - a. Place Water Heater switch in "Off" position.
 - b. Remove red wire from left-hand terminal of ECO switch (ECO to valve).

Water Heater Switch and "Pilot Out" Indicator

Be sure the water heater is filled with water before pressing this switch. To fill the water heater, turn the water pump switch on and open a hot water faucet until water begins to flow.

The "Pilot Out" light will glow for about 10-15 seconds after the water heater switch is turned on, then it will go off.

If the "Pilot Out" light comes on during normal operation, it means that the burner has gone into "lockout" mode. Turn the switch off for about 5 minutes, then turn back on.

Water Heater Capacity: 6 Gal.

Pressure-Temperature Relief Valve

On occasion, water may be seen seeping from the water heater pressure temperature relief valve. This is no cause for repair or replacement of the valve.

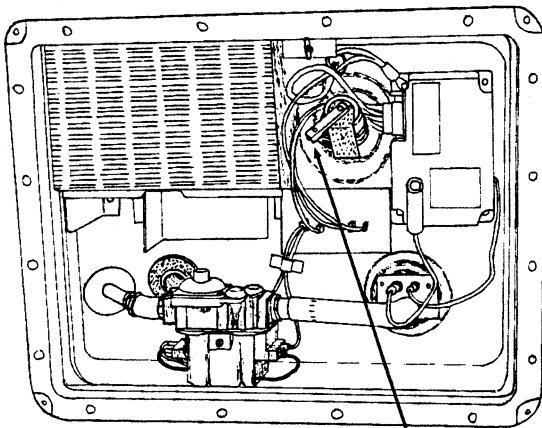

WATER HEATER
OUTSIDE ACCESS

P-T Relief
Valve

Normally there is an air gap at the top of the water heater tank which acts as a pressure buffer. In time, however, heated water may expand and fill this air gap, causing a slight increase in water pressure. This may cause the P-T valve to "weep" until the air gap is manually replaced.

OPERATE THIS VALVE ONLY WHEN THE WATER HEATER AND COOLING SYSTEM ARE COLD!

To Replace the Air Gap:

1. Turn off the water heater switch and incoming water supply (city water and/or demand pump).

2. Open a faucet in the motor home to relieve water pressure.
3. Pull the handle of the P-T valve straight out and allow water to flow until it stops.

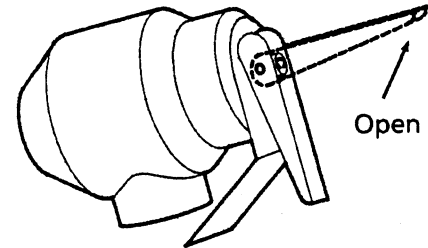

P-T VALVE

4. Let the handle of the P-T valve snap shut.
5. Close the faucet and turn on the water supply before switching the water heater on.

Manually operate the pressure thermostat relief switch at least once a year.

WATER HEATER BY-PASS VALVE - Optional

Your coach may be equipped with a water heater by-pass valve for easier winterization of water lines using RV antifreeze. The valve is located inside the coach near the water heater. Line up the arrow on the handle with the appropriate arrow on the valve plate to either by-pass or flow through the water heater.

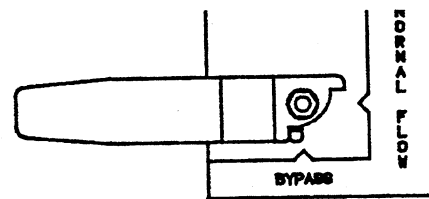

MOTOR AID (Optional)

The motor aid uses heat from the chassis engine cooling system to heat water in the water heater while driving. Hoses are routed from the engine to a heat exchanger surrounding the water heater tank.

Under normal conditions, the entire contents of the water heater can be heated to about 140°F in about two hours or 100 miles of driving. This means you can have hot water at the faucets immediately upon arriving at a site, or even while driving if needed.

The motor aid also increases the capacity of the engine cooling system, allowing the engine to run cooler under many conditions.

CAUTION

Any leak in the heat exchanger or its supply or return lines could cause loss of coolant and subsequent engine failure. We recommend that you periodically inspect these connecting lines and the heater to insure that no leaks have developed.

Motor Aid Water Heater and Rear Auxiliary Heater Maintenance

Have your authorized dealer check all hose clamp connections on the rear automotive heater and the motor aid water heater at least every six months and tighten them if necessary.

LP GAS FURNACE (SUBURBAN)

To Start Up:

1. Turn the furnace gas valve (if so equipped) or the valve at the outside LP tank to the "OFF" position. Do not force.
2. Move "OFF" lever located at bottom of thermostat to the right if set on "OFF" position.
3. Set thermostat above room temperature to begin blower operation. A slight delay will occur before the blower comes on. Allow blower to run for 5 minutes for combustion chamber purge cycle.
4. After 5 minutes, move thermostat lever below room temperature. Blower will remain on. Wait approximately 2 minutes for blower to go off.
5. Turn furnace gas valve ON. Correct operating characteristics depend on valve being positioned fully open. Never attempt to operate furnace with valve partially closed. Valve is fully open when handle is parallel to gas line.
6. Set thermostat to desired setting. If set above room temperature, blower will come on.
7. Allow 30 seconds for main burner to light after blower comes on. This furnace is equipped with an ignition device which automatically lights the burner. Do not try to light the burner by hand.
8. If burner does not light, repeat Steps 1 through 5.
9. If after three (3) attempts with no ignition, go to shut-down and contact your dealer or a local recreational vehicle service center. Do not continue to cycle furnace through thermostat in an attempt to get ignition.

To Shut Down:

1. Set thermostat to positive "OFF" position. (Move "OFF" lever on bottom of thermostat to "OFF" position.)
2. Turn manual shut-off valve (if so equipped) to the "OFF" position. Do not force.

Humidity and Condensation

Fogging may appear on the windows when there is excessive humidity inside the coach. In extremely cold weather this can become frost or even ice. To help reduce excess moisture, partially open a window or roof vent. Operating the range hood vent or powered roof vents will also help.

ROOF AIR CONDITIONERS

Refer to the manufacturer's information in your Motor Home Operations Manual binder for complete operating instructions.

AIR CONDITIONER SELECTOR SWITCH

(Vehicles with Two Roof Air Units) Optional

On models 28RQ, 32RQ, and 34RA, the roof air selector switch is located beside the power converter panel. On model 40DA, it is located on the lower galley cabinet face.

Since an external 110-volt power source (shoreline hook-up) can only handle operating one roof air unit at a time, the selector switch is provided to allow you to select the unit of your choice - front or rear.

Both roof air units can be used at the same time in vehicles equipped with 6,500 or 7,000-watt auxiliary generators if the 110-volt shoreline is plugged into the auxiliary generator.

To allow generator start-up without excessive load, follow these steps:

1. Be sure both roof air units are switched OFF.
2. Start the generator.
3. Turn the A/C selector switch to the FRONT position.
4. Switch both roof air units ON.

TV ANTENNA - Optional

The TV antenna on your motor home can be easily raised, rotated a full 360° and lowered from inside the vehicle by simply turning a crank or rotating disc. Some models have a built-in signal amplifier designed to strengthen signals, which is controlled by a power switch built into the TV jack assembly.

The signal amplifier is housed inside the antenna with the circuit board connected directly to the antenna elements. Power to operate the amplifier (12-volt DC) is supplied through the downlead cable which also carries the TV signals

to the TV set. The power supply separates the 12-volt DC from the TV signals and provides a place for attaching the TV set and the 12-volt power source.

Operation

Raising Antenna - Turn elevating crank clockwise in "UP" direction about 13 turns or until some resistance to turning is noted. Antenna is now in operating position. Turn amplifier power switch "ON" to receive TV signal.

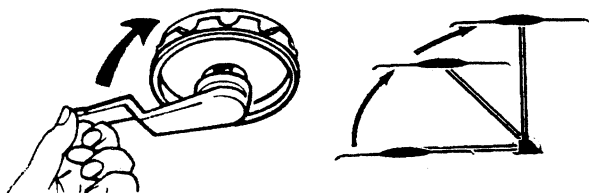

Rotating Antenna - Make sure antenna is in the "UP" position. Pull down on rotating knob until it disengages ceiling plate and rotate for best picture and sound on TV set.



Lowering Antenna to Travel Position - Rotate antenna until pointer on rotating knob aligns with pointer on ceiling plate.

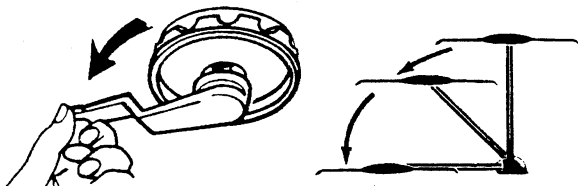

Turn elevating crank (counterclockwise) in "DOWN" direction until resistance is noted. Antenna is now locked in travel position. Turn amplifier power switch "OFF".

Count number of turns necessary on elevating crank to lower antenna until head is just resting on the roof of the vehicle. Mark position of elevating crank on ceiling or directional handle and number of turns (about 13). Use this number of turns when raising or lowering and stop at mark.

CAUTION

Never lower antenna to any position except travel position.

Always align directional knob to "DOWN" position before lowering.

Amplifier

To operate amplifier, turn on power switch.

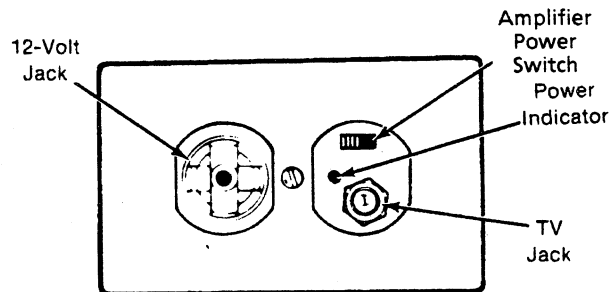

12-VOLT AND TV JACKS

The TV jack plates are mounted in various locations throughout the coach. Some of these wall plates are not readily visible and may be in one of the following locations:

- Behind pull-down TV shelf/mirror in bedroom.
- Forward of driver's compartment rear view mirror.
- In front TV cabinet, if equipped
- In a passenger side exterior cargo compartment.

Checking Performance

The TV signals available to an RV are entirely dependent on its location in relation to the transmitter. Signals may vary from very strong to no usable signal at all. We recommend that the TV system be checked out in an area known to have good TV reception.

WARNING

Observe antenna height while parked to prevent contact with electrical wires, power lines, etc.

Cable TV Hook-Up

Some models are equipped with external connections for cable television. The connector is located in the shoreline cord compartment.

SECTION 9

INTERIOR FEATURES AND FURNISHINGS

(See also Safety Precautions, Section 1 of this manual.)

IMPORTANT

Some items described may be optional or unavailable on your vehicle.

SLEEPING FACILITIES

WARNING

Do not use sleeping facilities while vehicle is in motion.

Latch the pull-down bunk securely in position when the vehicle is in motion or when the bunk is not in use. Do not use for storage.

FRONT PULL-DOWN BUNK (Optional)

To Lower:

1. Recline the driver and passenger front seats.
2. Pull the front privacy curtain ahead to increase side clearance.
3. Be sure sunvisors are against the windshield.
4. Release the latches at the rear of the bunk. (Push up center button of latch to unlock latch handle.)
5. Using the strap handle, pull the bunk downward into position.

To Raise:

1. Remove any items from the bunk which could contact the ceiling or otherwise prevent the bunk from fully retracting.
2. Lift the bunk upward into the stored position and refasten the latches.

COUCH/BED CONVERSIONS

Continental Bed

To Convert Couch to Bed:

1. Remove the backrest cushions from the couch.
2. Grasp the front edge of the couch and pull upward and outward from the wall at the same time.
3. Lift the front edge of the seat cushion and unfold it toward the wall until it lies flat, forming a sleeping surface.

To Revert to Couch:

1. Fold the mattress forward from the wall to return the seat cushions upright.
2. Pull the front of the couch upward and push in toward the wall at the same time until fully seated against the wall.

3. Place the backrest cushions in their original locations.

DINETTE/BED CONVERSION

To Convert Dinette to Bed:

1. Release the catch on the table leg brace and fold the leg up against the bottom of the table.

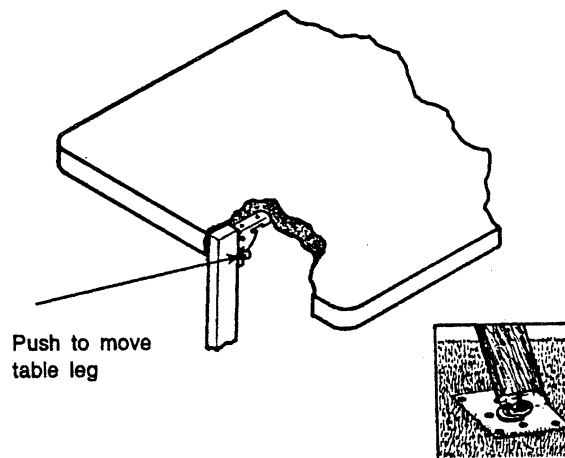

2. Remove the table from the wall support bracket by lifting the end of the table. Then lower the table to rest on the cleats attached to each dinette bench.
3. Arrange dinette cushions to cover bed area.

To Revert to Dinette:

1. Replace table onto the wall support and lower the table leg.
2. Make sure that the table leg is secured into the floor support bracket and the leg brace is locked.

FRESH WATER TOILET

The fresh water toilet in your motor home is very similar to the household type, except that it is designed to use only a small amount of water per flush. It uses a high velocity jet of water, producing a swirl effect, to efficiently cleanse the bowl. And since each flush uses fresh water, no special chemicals are required other than a deodorizing agent, if necessary.

Thetford Model SL Toilet

1. To add water to the bowl before using, step on the small pedal at the base of the toilet. Hold until the desired water level is reached. Generally, more water is required only when flushing solids.

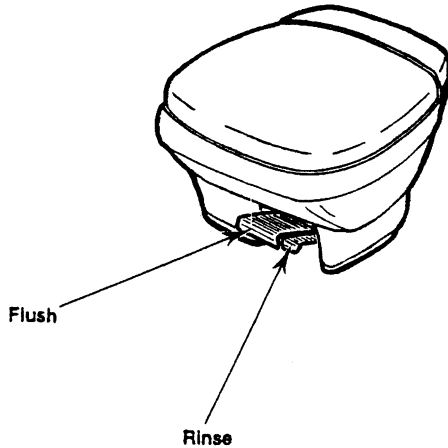

2. To flush the toilet, step on the large pedal, which opens the flush valve and begins rinsing. Hold pedal until bowl is clean.
3. Release flush pedal. A small amount of water should remain in the bowl.

Please refer to the manufacturer's information supplied with the toilet for further operating and maintenance instructions.

Thetford Aqua IV Toilet

1. Add water to the bowl before using, move the white lever to the right. Hold lever until desired level of water is reached. Release lever slowly - do not allow it to snap back. Generally, more water is required only when flushing solids.

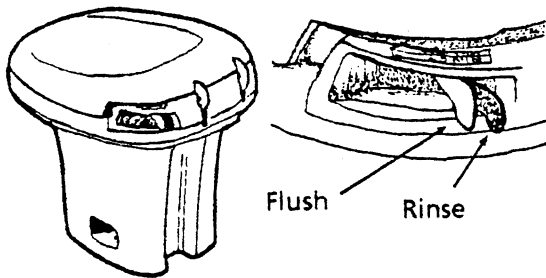

2. To flush the toilet, move the black lever to the right. (The black lever also moves the white lever.) Hold lever until bowl is clean.
3. Release lever slowly. A small amount of water should remain in the bowl.

Please refer to the manufacturer's information supplied with the toilet for further operating and maintenance instructions.

SeaLand Porcelain Toilet - Optional

1. To add water to the toilet before using, lift the flush lever until the desired water level is reached. Generally, more water is required only when flushing solids.

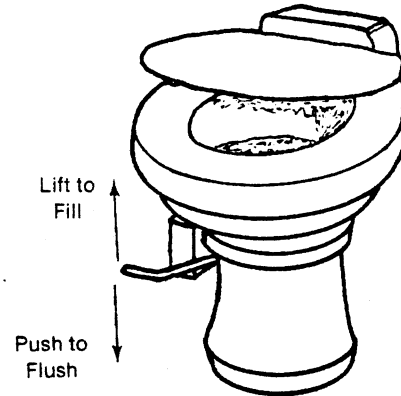

2. To flush the toilet, push the lever all the way down until sewage leaves the toilet and bowl is rinsed clean.
3. Release the flush lever. A small amount of water should remain in the bowl.

Please refer to the manufacturer's information supplied with the toilet for further operating and maintenance instructions.

Important "Don'ts"

- Don't use facial tissue or regular toilet tissue in the RV toilet. These will not disintegrate sufficiently and will often cling to the sides of the holding tank. Toilet tissue made specifically for use in RV toilets and holding tanks is available at most RV supply centers.
- Don't dispose of sanitary napkins or other non-dissolving items in the toilet.
- Don't put automotive antifreeze or caustic chemicals, such as laundry bleach or heavy detergents into the toilet or holding tank. These products may damage plastic or rubber parts in the system.

Cleaning the Toilet

The toilet should be cleaned regularly for maximum sanitation and operating efficiency. If an odor is apparent from the toilet:

1. Clean the toilet bowl with a mild bathroom cleaner. Do not allow cleaners to set in the bowl for long periods of time to avoid damaging the seals. Do not use caustic or abrasive cleaners in the Thetford toilet since it may damage the plastic surfaces.
2. Dump and rinse holding tank.

3. Add odor control chemical in amount specified after cleaning and every few days during use.
4. Remove the water line from the base of the toilet and clean the screen.
5. If the flush valve becomes stiff after extended use, it may be lubricated with a silicone spray. Turn the water pump off and operate flush pedal/lever to drain water from the toilet bowl. Spray silicone lubricant onto flush valve inside bowl and operate flush pedal/lever a few times to ensure free operation.

See instructions in Section 11 to prepare the toilet for storage in freezing conditions.

POWER ROOF VENT - Bath Area

Some models are optionally equipped with a powered roof vent in the bath area. A push button switch for the vent fan is located up on the vent. The vent dome can be raised and lowered using the crank handle.

POWER ROOF VENT - Galley Area

Some models may be optionally equipped with a powered roof vent in the galley area of the motor home.

A switch on the vent panel controls fan on/off and fan speed. When the fan speed selector is in any of the three ON positions (Lo-Med-Hi), the fan motor will start automatically as the dome is raised. The fan will stop when the dome is closed.

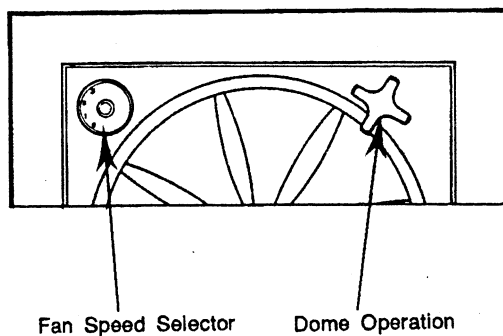

If the fan is not desired, turn the selector to OFF.

CRANK-OUT SIDE WINDOWS

Turn the crank-out knob clockwise to open window; counter-clockwise to close. Do not use excessive force on the knob to open or lock into closed position. This could cause permanent damage to the crank mechanism.

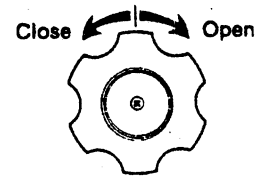

If the window will not open after three or more full turns of the knob, the glass may be stuck to the sealing gasket. Go to the outside of the coach and gently free the glass with your fingers. A periodic light dusting of talcum powder on the gasket should prevent this from recurring.

SECTION 10 CARE & MAINTENANCE

CAUTION

Sealants must be inspected every 6 months and resealed if necessary.

ROOF

The roof utilizes Thermo-Panel[®] construction like the walls and floor. It will support the weight of an average adult should it become necessary to repair the roof or roof mounted components. It is not recommended, however, that very large or heavy objects be carried on the roof while the vehicle is in motion. Always have damage to the roof area repaired immediately. Damaged or detached sealant around the vents, air conditioner, body-to-roof seams, etc., should also receive immediate attention. Delaying these repairs may allow water leakage and result in damage to interior ceiling and body panels, upholstery, etc.

UNDERBODY

Buildup of mud and dirt under the body can cause damaging rust on steel parts and can add needless weight to the vehicle. This, in effect, reduces the amount of cargo you can carry and remain within GVWR and GAWR limits.

Corrosive materials, such as those used for ice and snow removal and dust control, also accumulate on the underside of a vehicle. These materials should be removed by flushing the underbody regularly with water, especially areas where mud and other foreign materials collect.

EXTERIOR

The exterior surface of your motor home has an automotive finish. Frequent washing and thorough cleaning is recommended to prevent damage to the vehicle finish after exposure to damaging salts, calcium chloride, road tar, tree sap, insects and other foreign material. Never wash the vehicle in direct sunlight, while the vehicle surface is hot, or using hot water.

Do not use strong soaps or detergents for washing the motor home. Always use a mild soap in warm water, a commercially prepared product for cleaning automotive finishes or your local car wash. Be careful when using pressure-type washers to avoid loosening exterior decals or sealants, etc.

After washing the motor home, carefully inspect caulking around window frames and vents and any other joints that may have separated.

Recaulking, if necessary, is quite simple. Appropriate compounds are sold at Itasca dealers, and the materials are quickly and easily applied. Also, inspect weather seals around door, etc., and if necessary have a dealer replace them immediately.

CAUTION

Never use a strong solvent such as lacquer thinner, or harsh abrasives on painted surfaces.

It is recommended that a coat of automotive wax be applied to the surface occasionally to provide added protection against harmful deposits coming in contact with the paint.

Compartment Doors

Apply powdered graphite lubricant to compartment door latches periodically as necessary to keep latches operating smoothly.

UPHOLSTERY, CARPETING AND DRAPERIES

Upholstery and Carpeting

We recommend a weekly routine of vacuuming all fabrics and carpet throughout the motor home to prevent an accumulation of dirt which can detract from the appearance and shorten the life of carpet and fabrics.

Some fabrics used in this motor home may contain fire retardant and lightfastness additives which can be damaged by use of improper cleaning products. Some water-based household cleaning products are not formulated for use on fabrics and may cause excessive shrinkage or fading. Always test any cleaning product on a hidden area of fabric before using on visible areas. For best results, fabric cleaning should be referred to a professional carpet and upholstery cleaner.

IMPORTANT

To minimize fading of upholstery, carpets and other interior fabrics caused by excessive sunlight, the drapes, blinds or shades should be closed when the motor home is parked for an extended period of time.

WARNING

When cleaning upholstery, carpet and fabric, do not use lacquer thinner, nail polish remover, laundry soaps, or bleach. Never use carbon tetrachloride, gasoline, or naphtha for any cleaning purpose. These materials may cause damage to the material being cleaned and most are highly flammable.

Spots and Stains

Spots or stains should be treated as soon as possible before they "set in" to avoid permanent damage. Always start from the outside of a spot or stain and work inward to avoid spreading it. Use a clean cloth or sponge and turn frequently to an unused area of the cloth or sponge as you clean.

Some stains or soils, such as lipstick, ink, grease or mustard, are extremely difficult or impossible to remove completely and should receive immediate attention. Consult a professional carpet and upholstery cleaner for assistance.

Vinyl Fabrics

Vinyl should be cleaned with a soft, damp cloth and a mild detergent only. Do not use solvents. Solvents may damage the surface of the vinyl.

Draperies, Curtains and Bedspreads

These items may be woven from a variety of fabrics. We recommend that these be professionally dry cleaned only. A five percent shrinkage may occur when you have these items dry cleaned.

CABINETRY

Wooden items may be cleaned with a soft cloth and a good quality wood finish cleaning product such as Pledge™, Liquid Gold™, etc.

Vinyl simulated wood (Plus-Wood®) panels may be cleaned with a mild, water based cleaner and a soft cloth. Do not use solvents on vinyl wood panels.

NOTE: Many cabinetry and furniture items throughout this motor home are constructed either partially or completely of real hardwoods. Because of natural variations in woodgrain density, slight differences in stain hue may exist between one item and another. This is the distinctive character and beauty of real wood.

TABLES AND COUNTERTOPS

Work surfaces are covered with a plastic laminate that is resistant to solvents, stains and abrasions. A coat of furniture wax applied to these surfaces on the counters and table will help preserve their beauty and make cleaning easier. Always clean the surface before applying wax.

AVONITE® COUNTERTOP

The galley countertop on some models is made of Avonite®, a plastic/fiberglass composite material which is extremely durable and may be refinished by trained personnel if damaged by minor scratches, nicks or chips.

STAINLESS STEEL SINK

The stainless steel sink can be cleaned with soap or detergent. Rinse thoroughly with warm water and wipe dry to avoid streaks.

Use a mild abrasive for stubborn stains. Work in the direction of the polish lines. To keep the original finish, polish with a wax cleaner and rub with a dry soft cloth.

WARNING

Salt, mustard and mayonnaise may cause pitting. If spilled, clean immediately.

RANGE AND REFRIGERATOR

For care and appearance maintenance of the range and refrigerator, refer to the operation and maintenance manual for each of the individual appliances included in your Motor Home Operation Manual binder.

FLOORING - PARQUET WOOD

The wooden parquet flooring in the galley area is finished with a durable, polyurethane coating. To keep it clean, sweep or vacuum regularly. Buff with a soft bristle brush periodically to renew the shine. **Never damp mop.** Wipe spills immediately with a dry cloth.

BATHROOM

The shower walls in the bathroom should be cleaned with a mild soap and water solution, or (to obtain maximum luster) use a good quality wax cleaner. Do not use an abrasive cleaner on the shower walls. However, a mild abrasive cleaner may be used to clean the shower floor or bathtub. If the shower has a Plexiglass door, it is extremely important that abrasives not be used. Solvents and aromatic spirits that contain a petroleum base or additive should also not be

used. These products can cause a reaction with the glass that results in visible deterioration marks. Use only a mild detergent and water solution with a soft cloth to clean Plexiglass surfaces.

The bathroom lavatory is also a molded plastic material and should be cleaned with a mild soap and water solution. Abrasive cleaners or harsh detergents should not be used.

For instructions on the care of your fresh water toilet, refer to the information in your Motor Home Operation Manual binder.

WASHERLESS FAUCET O-RINGS

Your coach is equipped with washerless faucets for greater reliability. Over time, however, even washerless faucets may begin to drip. This is because water mineral deposits or other foreign debris may damage the O-ring seals. To accommodate this possibility, all 2-knob lavatory faucets* are supplied with an extra set of O-rings for faucet leak repairs. These are located beneath the knob caps, labeled "HOT" and "COLD". To access, pry the caps off gently using a small screwdriver or penknife blade.

*Also the galley faucet on some models.

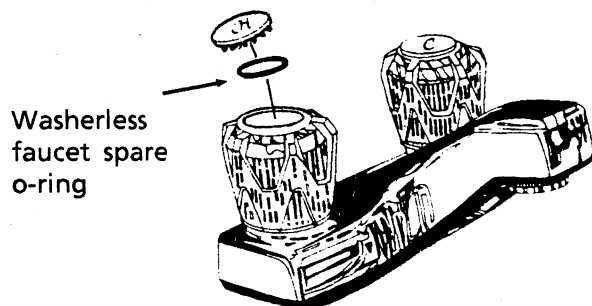

Washerless faucet spare o-ring

DOORS AND WINDOWS

Windows may be periodically cleaned with a good quality glass cleaner or mild soap solution using a soft cloth. Use care when removing ice or frost from the windows. Always use a plastic ice scraper, never one made of metal. Use care when removing ice from the mirrors to protect the reflective surfaces.

Door locks and hinges should be lubricated periodically with powdered graphite to ensure trouble-free operation and to protect against freeze-up.

WINDOW ROLL-UP SHADE ADJUSTMENT

If a roll-up type window shade in your motor home does not roll up or down fully, the spring tension may need adjustment.

Spring Too Weak:

- Roll shade about half-way down on window.
- Remove shade from bracket.
- Roll shade snugly by hand and replace onto bracket.

Spring Too Strong:

- Roll shade all the way up.
- Remove shade from bracket.
- Unroll shade one or two turns as necessary by hand and replace onto bracket.

PLEATED WINDOW SHADE ADJUSTMENT

Pleated shades will lose their shape if left in a lowered position for an extended period of time.

If a pleated shade loses its shape, the pleats can be restored using this method.

- With the shade fully lowered, dampen the shade thoroughly with a good quality laundry spray starch
- Raise the shade fully and let it remain raised for about 24 hours, until the starch has dried and "set".
- Reapply starch periodically (every few months) as needed.

We recommend that you fully raise pleated shades when they are not in use, especially in warm environments, to prevent them from losing their shape.

VEHICLE MAINTENANCE

(See also Safety Precautions, Section 1 of this manual).

CHASSIS SERVICE & MAINTENANCE

Consult the appropriate sections in your chassis operating guide for specific information regarding operating safety, service recommendations and maintenance schedules for the chassis section of your motor home.

ENGINE ACCESS

Hood

The hood release lever is located on the steering column bracket near the bottom of the dash. To open, pull out on the knob and the hood will pop open. Lift up the hood and secure it with the hood support rod.

With the hood open, the engine oil dipstick, oil fill, radiator fill, power steering reservoir and windshield washer reservoir are accessible.

IMPORTANT

When closing the hood, push down firmly to ensure that it latches properly and test by attempting to pull up on it.

Engine Cover

Remove the four (4) bolts securing the engine cover to the floor of the driver's compartment and lift cover off to gain access to engine.

Removal of the engine cover allows service access to the transmission dipstick and fill tube, engine air cleaner, and other engine parts.

ENGINE COOLING SYSTEM

Refer to your chassis operating guide for information and precautions on filling, servicing and checking the fluid level.

CAUTION

When refilling the coolant system of a vehicle equipped with a rear auxiliary automotive heater and motoraid water heater, be sure to allow for additional coolant capacity of the heater and its supply and return hoses.

TIRES

Low air pressure results in tire overloading and abnormal wear and also affects handling and fuel economy. Obtain proper inflation pressures from your chassis operating guide or tire manufacturer.

WARNING

Radial ply tires are optional on some models. The tire option is not intended to upgrade the load rating of the entire vehicle and does not imply that GVWR and GAWR ratings may be increased over the figures found on the certification label.

Make sure all replacement tires are of the same size and ply rating as those installed as original equipment.

SUSPENSION ALIGNMENT AND TIRE BALANCE

The front suspension and steering system of this vehicle was factory aligned using highly accurate equipment prior to delivery to the dealership. However, we recommend that alignment be checked and, if necessary, adjusted after you have fully loaded the motor home according to your

personal needs. Thereafter, the alignment should be periodically inspected to help prevent uneven tire wear.

Any excessive or abnormal tire wear may indicate worn or misaligned suspension or steering, unbalanced tire or other tire/suspension problem.

Alignment can be affected by worn steering/suspension parts or by incidents which happen during driving, such as hitting a curb, pothole or railroad track, etc. Improper alignment can cause tires to roll at an angle and wear unevenly. It may also cause the vehicle to "pull" to the right or left. Have your dealer inspect your vehicle's suspension and steering components periodically for misalignment or wear.

Out-of-balance tires will not roll smoothly and can lead to annoying vibrations and uneven tread wear such as cupping and flat spots. Tires may need to be balanced if uneven wear is detected or if ride comfort decreases noticeably.

See your chassis operating guide for further information.

4-WAY® FRONT STABILIZER SHOCKS

If your coach is equipped with 4-Way brand front stabilizer shocks, they must be adjusted by your dealer after you have loaded the motor home to your personal needs. These shocks may be easily identified by their bright yellow color.

These shocks are adjusted at the factory for an unloaded coach for proper performance during delivery transit. Failure to readjust stabilizer shocks after loading the coach may result in damage to the shocks or other suspension parts.

REAR AIR SPRINGS

Some models may be optionally equipped with pneumatic air bag rear helper springs. The fill valve(s) for these springs are located on the valance panel, near the rear tires, on either side of the vehicle.

Air pressure must be maintained at a minimum of 30 psi and a maximum of 90 psi. Detailed information regarding adjustment of air springs is provided in your Motor Home Operation Manual binder.

LIGHTS

All exterior lights should be checked for proper operation each time the vehicle is prepared for a trip. Any bulbs which fail to light should be checked and replaced, when necessary, with a new bulb of the same size. A failure of more than one light, such as both taillights not operating, may indicate a burned out fuse. Check fuse and

replace with one of the same rating when necessary. If a fuse is not the cause of the problem, the wiring system should be checked immediately by an authorized service center.

The headlight circuit is protected by a circuit breaker. An overload on the breaker will cause the lights to flicker on and off. Headlight wiring should be checked immediately anytime this condition is apparent. Refer to your chassis operating guide for further information.

CARE OF OPTIONAL ALUMINUM WHEELS

If your aluminum wheels should become dull or discolored by road film, use any commercially available designated aluminum wheel cleaner-polish to restore the bright finish. The wheel manufacturer suggests monthly cleaning during constant daily use and less frequently with decreasing use.

REAR TAG AXLE INFORMATION (Model 40DA only)

This model is equipped with an independent, torsion sprung, tag axle that helps to minimize body roll, leaning and rear end sag.

In Case of Temporary Traction Loss

Should an uneven surface (such as driveway entry) cause the drive wheels to lose contact with the drive surface, you may experience a momentary loss of mobility. In this event, remove your foot from the accelerator and allow approximately 8-12 seconds for the axle system to adjust itself and restore traction.

NOTE: If the distance from the drive wheels to the drive surface is beyond the adjustment capability of the system, towing assistance may be required.

Compressor Operation

The compressor, which is located under the lavatory area, will operate periodically to maintain pressure in the air reserve tank. A brief "hiss" may be heard when the compressor stops and when the ignition is switched off. This is a normal pressure bleed-off function of the compressor and is no cause for alarm.

NOTICE: Before starting the engine after any extended period of storage or non-use, we recommend that you pre-fill the tag axle suspension system with air. This will save "wear and tear" on the air compressor by reducing initial operating time.

To do this, add air through the valve on the air tank with a standard (tire) air chuck.

Fill the tank to 100 psi maximum, measured using a tire gauge on the fill valve. Then, start the vehicle to allow the system to equalize itself automatically.

Moisture Purgng

The air tank is mounted on the underside of the vehicle between the rear axles and the fuel tank. A drain valve is mounted on the bottom of the air tank to allow you to purge the condensation that normally forms on the inside of the tank.

The valve is operated by pulling on a cable which is attached to the valve. The cable is suspended from the chassis rail behind the passenger side rear tag wheels.

To purge moisture from the air tank, pull on the cable momentarily and release repeatedly until water is no longer seen spraying from the valve on the bottom of the tank. This operation should be performed weekly during periods of normal use.

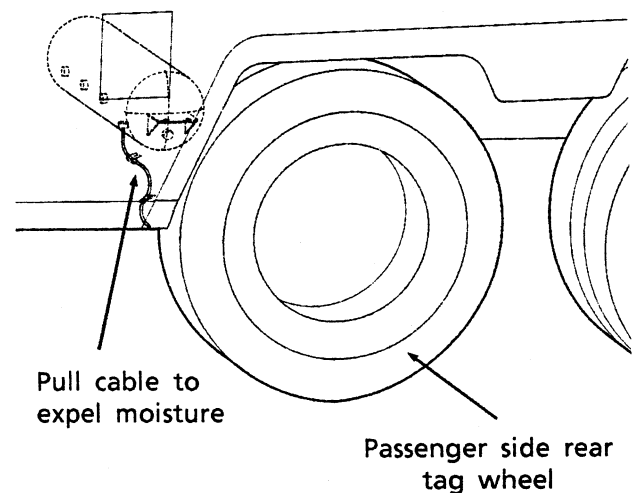

CAUTION

The LOW AIR warning light, located on the instrument panel, will illuminate if a low air condition should occur in the tag axle/rear suspension system. If this should occur while driving, the vehicle may be carefully driven to the nearest Winnebago dealer or a qualified truck air suspension service center. Although this condition does not totally disable the vehicle, it will cause less than satisfactory ride characteristics and should be serviced as soon as possible to restore proper performance.

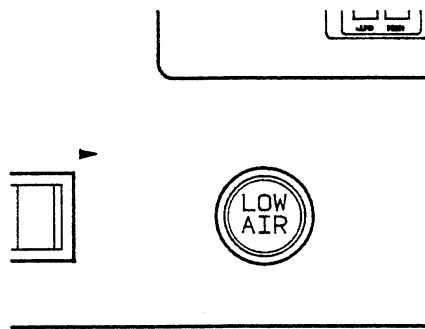

Low Air Warning Light

Lubrication and Maintenance

The tag axle bearings require annual and periodic maintenance as described below to ensure maximum performance and durability. Service is required at more frequent intervals under severe operating conditions.

CAUTION

Failure to correctly maintain proper lubrication in the bearings may result in bearing damage, which could cause the wheel to seize or become detached during operation.

Periodically - Using a manual grease gun, add 2-3 strokes of lithium base wheel bearing grease through the zerk fitting in the center of the tag axle bearing dust caps. This should be performed at regularly scheduled intervals, such as oil changes or chassis lubrications.

Yearly - Bearing components should be inspected at each 12,000 miles or at least annually, especially when returning vehicle to service after storage periods, to ensure that no abnormal wear or bearing setting has resulted. Repack bearings, cups and dust covers with lithium base wheel bearing grease and reinstall assembly. Due to the critical nature of wheel bearing adjustment, we recommend that this operation be performed by your dealer.

AUTOMOTIVE 12-VOLT CIRCUIT BREAKERS

The automotive electrical circuits are protected from short circuits and overloads by a circuit breaker panel. This panel is located below the left-hand side of the dash.

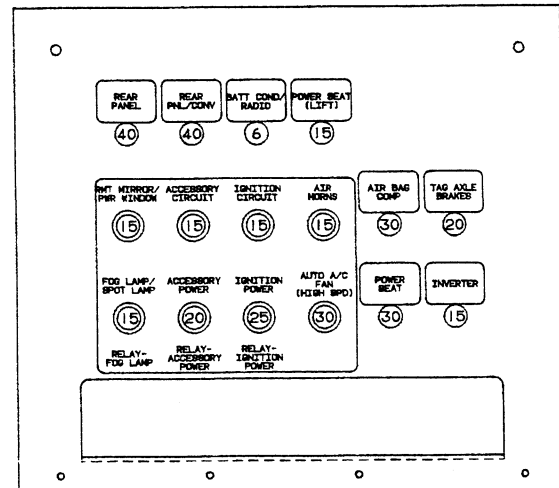

Automotive/Coach Circuit Breakers (Typical)

Each pop-out circuit breaker is labeled according to the circuit it protects. When a breaker is tripped, it will pop out from its normal position. To reset a breaker, press it in toward the panel.

SECTION 11

STORING YOUR MOTOR HOME

PREPARING VEHICLE FOR STORAGE

Properly preparing your vehicle for storage will lessen the possibility of damage to your vehicle. Prepare the motor home for vacancy just as you would if you were leaving your house for an extended period:

- Remove all perishables from cabinets and refrigerator.
- Prop refrigerator door open.
- Turn off LP gas tank.
- Drain water heater, water tank and holding tank.
- Close shades to protect upholstery from sunlight

When storing your vehicle through the winter, or in cold climates, extra preparations need to be made to protect systems that can be damaged by freezing temperatures.

Cold Weather Storage Procedure (Winterizing)

1. Clean and dump holding tanks by following steps A, B, and C.
 - A. Add water to the sewage holding tank by holding the toilet flush lever open with the water pump running. Add water to the waste water holding tanks by opening the kitchen, shower and lavatory faucets. Tanks should be about 1/4 to 1/3 full to rinse properly. Driving to a disposal site will normally loosen and rinse any waste material from the sides of the tanks.
 - B. Completely drain the sewage and waste water holding tanks at an approved waste disposal site. Drain the sewage tank first so the following waste water can rinse any waste solids from the dump outlet and sewer hose.
 - C. Close dump valves and refit the dust cap onto the drain outlet.
2. Level the motor home and drain the entire plumbing system as described in the following steps.
3. Open all drain valves by pulling their ring handles up about 1/2". (See the water system drain valve chart on page 7-5 for locations on your model.) To close the valves, simply push the valve shafts down until they are fully seated.

NOTE: If your coach is equipped with a water purifier system, you will need to remove the filter cartridge and install the diverter plug supplied. The cartridge is located

beneath the galley sink counter. The diverter plug must be removed and a filter cartridge installed before resuming normal use of the water system. The plug is intended for winterization only.

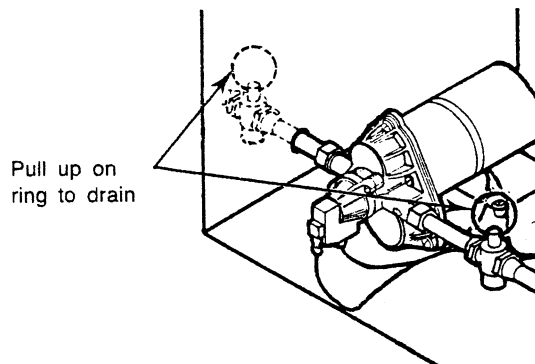

4. Turn the Water Pump switch ON to allow it to operate until you are done draining all faucets and toilet.
5. Open all faucets including the shower head valve.
6. Operate the toilet flush lever and hold until water stops flowing in the toilet. Then turn water pump switch OFF.
7. Turn off the water heater power switch before draining the water heater tank to avoid damage to the heating element.
8. Drain the water heater by removing the plug from the base of the water heater tank, accessible from the outside of the coach. (Requires socket and ratchet.) Also open the Pressure-Temperature relief valve at the top right portion of the tank to prevent air locking in the tank while draining.

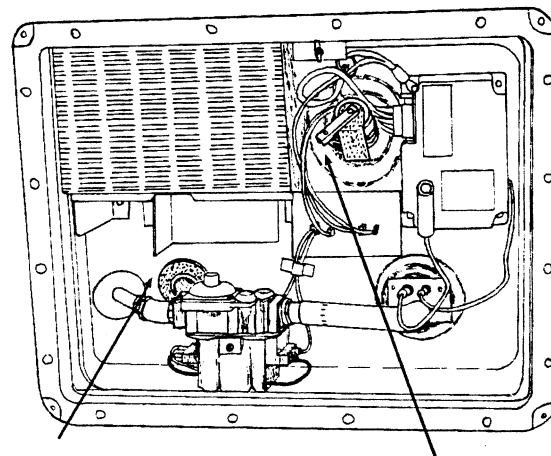

Drain Plug

P-T Relief Valve

9. After water has stopped draining at all faucets and drain valves, connect a "blow-out" plug to the city water connection on the coach. Then use a hand pump or air compressor to force air through the system. (A "blow-out" plug can be purchased at any Winnebago or Itasca dealer. P/N 701705-01-000.)

City Water
Connection

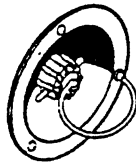

CAUTION

Limit air pressure to 30 psi to avoid damage to pump or water lines.

NOTE: DO NOT burst air into the system. This can damage the water pump. It is better to let air in slowly.

10. Let air flow for five minutes until water is completely drained out of faucets and drain valves. Then close faucets one at a time.
11. Operate and hold toilet flush lever until water is completely drained from toilet.

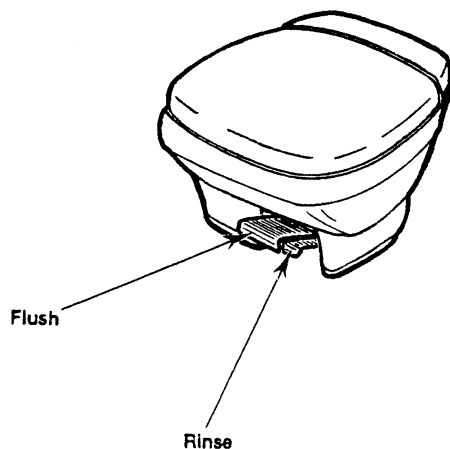

12. Now turn air pressure off and disconnect "blow-out" plug. Recap the city water connection to avoid contamination by dirt or insects.

13. Close all drain valves and faucets to avoid contamination by dirt or insects. Reinstall water heater drain plug and close P-T relief valve.
14. Pour about one cup of non-toxic RV antifreeze into the kitchen sink drain, bathroom sink drain and shower drain. This prevents any holding tank odors from entering the coach during storage.

WARNING

Do not use automotive radiator antifreeze. It is poisonous.

It is not necessary to add antifreeze to the toilet since the flush valve will be closed.

Do not add automotive antifreeze or caustic chemicals such as bleach or laundry detergents into the toilet bowl or holding tanks. Although these products may have a deodorizing effect, they may damage plastic and rubber parts in the system.

NOTE: As an alternative to totally draining the plumbing system, you may winterize tanks and lines by pumping non-toxic RV antifreeze through the system. This product is available from your dealer and from most RV supply stores. Follow directions on the container to determine the correct amount to use for your coach.

For pressure-fillable water systems (34RA), you may pump RV antifreeze into the water lines by following the "Special Instructions for Pressure-Fill Water Systems" listed on page 7-2. Be sure the tank fill valve is closed. It is more economical to pump solution into the water lines only, rather than into the water tank.

If your coach is equipped with the optional water heater by-pass valve, you can fill the hot water lines with antifreeze solution without filling the water heater tank. See page 8-7 for information on the by-pass valve.

15. Place a bucket beneath the sewage drain valve outlet and re-drain the sewage and waste holding tanks of any clean water that entered during "blow-out" procedure.

Close dump valves to prevent valve shafts from rusting and to prevent entry by rodents and insects. Refit the dust cap onto the drain outlet.

Your drainage and fresh water systems are now totally winterized.

16. Have the vehicle chassis completely serviced and lubricated. Be sure radiator antifreeze protection level is sufficient for the lowest anticipated temperatures.
17. Wash and wax the coach.
18. Inspect all seams and seal around doors, windows, vents, and any other joints. Replace or repair any that are damaged. Sealing materials and compounds can be purchased from your dealer. Badly damaged weather seals may need to be replaced by your dealer.
19. Close all windows and roof vents. Protect all appliance vent openings from contamination by animals or insects (e.g. bird nests, wasp nests, etc.)
20. Lubricate all door hinges and locks.
21. Clean the interior of the coach. Dirt and stains are more easily removed when fresh.
22. Remove all foods and items that may cause odors.
23. Clean and defrost the refrigerator. Leave the door slightly ajar to allow any odors to dissipate. Place an open box of baking soda inside the refrigerator to help absorb odors.
24. Turn the furnace thermostat switch on the bottom of the thermostat to OFF.
25. Disconnect all chassis and auxiliary battery cables.
26. Fully charge all batteries. Batteries must have at least 80% charge to survive freezing temperatures and long periods of non-use.

REMOVAL FROM STORAGE

1. Completely air out the motor home.
2. Have the entire LP gas system checked for leaks.
3. Check window operation.
4. Check cabinet and door hinges. Lubricate with penetrating oil, if necessary.
5. Close all faucets and drain valves that are open. If necessary, reconnect toilet water line and close flush valve.

6. Add a few gallons of water to the fresh water tank and check for leaks especially at junctions. Also make sure all hangers and supports are securely in place. Sanitize the water system as outlined under "Disinfecting the Fresh Water System" in Section 7.
7. Check operation of all faucets to be sure faucet washers have not hardened during storage.

NOTE: If equipped with water purifier system, reinstall filter cartridge.

8. Check sealing valve in the toilet for proper operation and lubricate with silicone spray.
9. Add water to the holding tank using the toilet flush pedal. Check to be sure dump valve seals tightly.
10. Check around all appliances for obstructions and ensure that all vent openings are clear.
11. Start refrigerator and check for proper cooling.
12. Clean paneling and counter surfaces and apply a thin coat of wax.
13. Replace batteries if necessary and check out electrical system to make sure all lights and electrical components operate.
14. Check tires for proper cold inflation pressure.
15. After washing accumulated winter grime from the vehicle, it is important to carefully inspect the seams and sealants for separation or cracks that may have appeared around the window frames, vents and any other joints. Re-sealing is quite simple and the material is quickly and easily applied. Appropriate compounds are available from your dealer. Also, inspect weather seals around doors, etc., and if necessary, have a dealer replace immediately.

INDEX

A

Air Conditioner, Automotive	2-9
Air Conditioner, Roof.....	8-10
Air Springs, Rear	10-4
Antenna and Signal Amplifier	8-10
Arm Rest Adjustment.....	2-5
Audio System - Radio/Cassette.....	2-11
Auxiliary Generator 110-Volt.....	6-3, 6-4
Auxiliary Generator Hourmeter.....	6-4, 8-4

B

Bathroom, Care of.....	10-2
Battery Charger, connecting.....	3-4
Battery Condition Meter.....	6-6, 8-5
Battery Information.....	6-6
Battery Isolator (Diesel only).....	6-6
Battery Mode Switch (DUAL-MOM).....	6-6
Beds, Converting for use	8-1
Before Driving Your Vehicle	2-1
Before Entering Your Vehicle	2-1
Brake, Parking.....	2-2
Bunk, Front Overhead.....	9-1
By-Pass Valve, Water Heater.....	8-9

C

Cabinets, cleaning.....	10-2
Cable TV Hook-Up.....	8-11
Capacities:	
Fresh Water Tank	7-1, 8-8
Fuel Tank.....	2-2
Holding Tanks	7-4, 8-8
Water Heater.....	8-8
Carbon Monoxide Warning	1-4
Carpets, Care of.....	10-1
Cassette Player/Radio.....	2-11
Chassis Service.....	10-3

Checklists

Pre-Travel.....	4-2
Emergency Equipment.....	4-2
Quick Loading	4-2
Circuit Breakers, 12-Volt:.....	6-5
Circuit Breakers, 110-Volt:.....	6-2
City Water Hook-Up, Flushing.....	7-2
Coach Battery Access.....	6-5
Cold Weather Storage.....	11-1
Comfort Controls	2-10
Converter, AC-DC Power.....	6-1
Cooling System, Engine.....	10-3
Couch/Bed Conversion	9-1
Crank-Out Windows	9-4
Cruise Control	2-9

D

Dinette/Bed Conversion.....	9-1
Disinfecting Water System.....	7-1
Door Handles and Locks.....	2-3
Doors and windows, Care of.....	10-3
Drain Valves.....	7-4

Drainage System (Sewage).....	7-3
Drains, Water System.....	7-4
Draperies, Care of.....	10-2
Drinking and Driving.....	ii
Driving Safety Precautions.....	1-1
Dual Rear Wheels	3-2
Dump Valves, Sewage	7-3

E

Electrical Outlets, 110-Volt.....	6-3
Electrical Safety Precautions.....	1-3
Electrical System, 110-Volt AC.....	6-1
Electrical System, 12-Volt DC.....	6-4
Emergency Equipment Checklist	4-2
Emergency Exit Window.....	1-4
Engine Access.....	10-3
Engine Cooling System	10-3
Engine Overheat.....	3-4
Engine, Starting and Stopping the.....	2-2
Entering Your Vehicle, Before	2-1
Exterior Body Care.....	10-1
Exterior Feature Identification	iv
External Power Cord (Shoreline).....	6-1

F

Faucet O-Rings, Washerless	10-3
Fire Extinguisher.....	1-5
Formaldehyde Warning.....	1-4
Fresh Water Tank.....	7-1
Fuel Caps, Replacement.....	2-2
Fuel Pump Shut-Off Switch.....	2-2
Fuel Selection, Vehicle.....	2-1
Fuel Safety Precautions.....	1-1
Fuel Tank, Filling Vehicle.....	2-2
Furnace, LP Gas.....	8-10
Fuses, 12-Volt	6-5, 10-4

G

General Warnings.....	1-1
Generator, Auxiliary 110-Volt	6-3, 6-4
Generator Hourmeter.....	6-4, 8-4
Ground Fault Circuit Interrupter (GFCI).....	6-3

H

Hazard Flashers	2-2, 3-1
Heater/Defroster	2-11
Heater, Rear Auto.....	2-11
Holding Tank, Dumping	7-3
Holding Tank Level Indicators	7-4
Hood, Engine.....	10-3
Hourmeter, Auxiliary Generator.....	6-4
Humidity and Condensation.....	4-4

I

Ice Maker	8-2
Instrument Panel	2-7,8
Interior Care	10-1

J

Jet Air Ride System	2-13
---------------------------	------

Jump Starting	3-3	Range Maintenance.....	10-2
K		Rear Air Springs (Air Bags).....	10-4
Keys.....	2-1	Recovery Towing.....	3-2
L		Refrigerator	8-1
Leveling Coach	2-13, 4-5	Refrigerator Maintenance	8-2
Lights, Replacing Exterior.....	10-4	Regulator, LP Gas	5-3
Loading, Roof.....	4-1	Relief Valve, Water Heater.....	8-5
Loading Safety Precautions	1-3	Removal From Storage.....	11-3
Loading the Vehicle.....	4-1	Reporting Safety Defects	ii
Locks	2-3	Restraints, Child	2-6
LP Gas Furnace.....	8-10	Roof Loading.....	4-1
LP Gas, How it Works.....	5-1	Roof Maintenance	10-1
LP Gas Leak Gauge.....	1-2, 5-4	Roof Vent, Power.....	9-2
LP Gas Leaks.....	1-2, 5-3, 5-4	S	
LP Gas Level, checking.....	8-8	Safety Defects, Reporting	ii
LP Gas Pressure Regulator.....	5-3	Sanitizing Water Tank (Disinfection)	7-1
LP Gas Safety Precautions.....	1-1	Seat Belts and Child Restraints	2-4, 2-5
LP Gas Selection.....	5-1	Seat Belts.....	2-4
LP Gas System, Safe Use of.....	5-1	Seats.....	2-4
LP Gas Tank	5-2	Service and Assistance.....	i, 10-3
LP Gas Tank, Air in the	5-2	Sewer Systems (Hook-Up)	7-3
LP Gas Tank Filling.....	5-2	Shade Adjustment.....	10-3
LP Gas, Traveling with	5-2	Shoreline Power Cord (Hook-Up).....	6-1
LP Gas, Winter Use of.....	5-5	Shower Hose Vacuum Breaker	7-2
LP Gas Works, How.....	5-1	Signal Lever, Multi-Function.....	2-9
M		Sink, Stainless Steel	10-2
Map Light.....	2-12	Smoke Alarm.....	1-5
Microwave Oven	8-7	Spare Tire.....	3-1
Mirrors, Rear and Side View	2-5	Speed Control	2-9
Monitor Panel	8-7	Springs, Rear Air.....	10-4
Motor Home Operations Manual (Binder).....	i	Starting and Stopping the Engine	2-2
Motor-Aid Water Heater.....	8-9	Step, Entrance.....	2-4
Mountain Driving.....	4-5	Storage, Removal From.....	11-3
Multi-Function Signal Lever	2-9	Storing, Cold Weather	11-1
N		Suspension Alignment	10-4
Nighttime Driving	4-5	Suspension Information, Rear	10-4
O		T	
Outlets, 110-Volt.....	6-3	Tables.....	10-2
Oven.....	8-5, 8-6	Thermal Breaker, Power Converter	6-2
Oven, Microwave	8-7	Tires	10-4
Oven Pilot.....	8-6	Tire Balancing	10-4
Overheated Engine	3-4	Tire Changing.....	3-1
P		Toilet.....	9-2
Parking Brake	2-2	Towing Your Vehicle.....	3-2
Power Roof Vent	9-2	Trailer Towing.....	4-1
Power Converter Location, 110V-to-12V	6-2	Travel Tips.....	4-3
Pre-Travel Checklist.....	4-2	TV Antenna.....	8-10
Pressure Regulator (LP Gas).....	5-3	TV Cable Hook-Up.....	8-11
Pump Switch, Water.....	8-8	TV Signal Amplifier.....	8-11
Q		U	
Quick Load Checklist	4-2	Upholstery Carpeting and Draperies.....	10-1
R		Under-Body Cleaning.....	10-1
Radio/Cassette Player	2-11	V	
Radio Switch.....	2-11	Vehicle Chassis Manual	i
Range.....	8-5, 8-6	Vehicle Certification Label.....	iii
Range Hood.....	8-7	Vent, Power Roof.....	9-2

Vinyl Fabrics.....	10-2
W	
Warnings	
Carbon Monoxide.....	1-4
Driving	1-1
Electrical.....	1-3
Formaldehyde	1-4
Fuel	1-1, 2-2
General	1-1
Generator, Auxiliary.....	6-3, 6-4
LP Gas.....	1-1, 5-1
Loading.....	1-3
Maintenance.....	1-3
Warranty	ii
Washerless Faucet O-Rings.....	10-3
Waste Drainage System	7-3
Water Pump.....	7-1
Water Pump Switch	8-8
Water Heater.....	8-8
Water Heater By-Pass Valve	8-9
Water Heater, Motor-Aid	8-9
Water Heater Relief Valve	8-9
Water Hook-Up, External.....	7-2
Water Hook-Up, Flushing	7-2
Water System, Disinfection of.....	7-1
Water Tank, Filling Instructions.....	7-1
Water Tank, Preparing for Storage	11-1, 11-2
Water Tank Drain Valve Locations.....	7-4
Weather Information, Severe	4-4
Weighing the Vehicle	4-1
Wheel Nuts	3-2
Window Cleaning	10-3
Window Shades	10-3
Windows, Crank-Out	9-2
Windows, Emergency Exit.....	1-4
Windshield Wiper/Washer Switch.....	2-9
Winterizing.....	11-1

**IMPORTANT
SERIAL NUMBERS**

Motor Home (Coach): Year _____ Model _____ Serial _____
Chassis: Make _____ Serial (VIN) _____

Roof Air Conditioner:	Brand _____	Model _____	Serial _____
Furnace:	Brand _____	Model _____	Serial _____
Water Heater:	Brand _____	Model _____	Serial _____
Power Converter:	Brand _____	Model _____	Serial _____
110-Volt Generator:	Brand _____	Model _____	Serial _____
Range:	Brand _____	Model _____	Serial _____
Microwave Oven:	Brand _____	Model _____	Serial _____
Refrigerator:	Brand _____	Model _____	Serial _____
Television:	Brand _____	Model _____	Serial _____
Video Cassette Player:	Brand _____	Model _____	Serial _____

EMERGENCY INFORMATION

Dealer

Name _____

Address _____

Phone _____

INSURANCE POLICY

Company _____

Policy Number _____

Phone _____



Built Proudly By Winnebago Industries.

Actasca[®]
A DIVISION OF WINNEBAGO INDUSTRIES, INC.

054185-74-000