

TO THE OWNER

Congratulations! We welcome you to the exciting world of motor home travel and camping. You will find it convenient and enjoyable to have all the comforts of home and still enjoy the great outdoors wherever you choose to go.

Your Ultimate Freedom motor home has been carefully designed, engineered and manufactured to provide dependability as well as safety. Before sliding into the driver's seat, take a few minutes to become familiar with operations and features. This manual was prepared to aid you in the proper care and operation of the vehicle and equipment. We urge you to read it completely. In addition, spend some time with the dealer when you take delivery, you will want to learn all you can about your new motor home.

Your new motor home is covered by a factory warranty against defects in material and workmanship. This warranty should be validated at once and returned to the factory by your dealer.

About Safety Messages Used in This Manual

Throughout this manual, certain items are labeled Note, Caution, Warning or Danger. These terms alert you to precautions that may involved damage to your vehicle or a risk to your personal safety. Read and follow them carefully.



This SAFETY ALERT SYMBOL is used to draw your attention to issues which could involved potential personal injury. This symbol is used throughout this manual and/or on labels affixed on or near various equipment in this motor home.



DANGER

DANGER indicates a directly hazardous situation which, if not avoided, will result in death or serious personal injury.



WARNING

WARNING indicates a potentially hazardous situation which, if not avoided, could result in death or serious personal injury.









CAUTION

CAUTION indicates a potentially hazardous situation which, if not avoided, could result in damage mainly to equipment or property, but in some cases may also result in minor or moderate personal injury.

NOTE: A 'Note' is not necessarily safety related but indicates a recommendation or special point of information that could assist in understanding the use or care of a feature item.

OWNER'S NAME
STREET ADDRESS
CITY AND STATE (OR PROVINCE IN CANADA)
MOTOR HOME SERIAL NUMBER
VEHICLE CHASSIS IDENTIFICATION NO. (VIN)
DATE OF DELIVERY TO FIRST RETAIL PURCHASER
VEHICLE MILEAGE AT TIME OF DELIVERY
SELLING DEALER NAME AND ADDRESS

TANK CAPACITIES	
	Spartan Diesel Chassis Fuel Tank..... 100 gal. (single tank w/dual fills)
	LP Gas Tank.....31 gal. (39 gal. w.c.)
	Fresh Water Tank99 gal.
	Water Heater Continuous
	Black Water Holding Tank (Toilet).....50 gal.
	Grey Water Holding Tank (Galley, Shower & Lavatory)54 gal.

*LP Gas tank capacity shown is the usable “full” LP gas capacity, which is 80% of the tank manufacturer’s listed water capacity (w.c. shown in parenthesis). An LP tank must have at least 20% of tank volume free to allow for expansion and proper vaporization of the liquid fuel. The tank is also equipped with mandatory safety shut-off equipment that prevents filling above this level.

**2004 NEW VEHICLE LIMITED WARRANTY
WINNEBAGO INDUSTRIES, INC.**



WARRANTY COVERAGE TO OWNER

Winnebago Industries, Inc. of Forest City, Iowa warrants each new Winnebago Industries motor home to the owner for use in the U.S.A. and Canada as follows:

WARRANTY PERIOD

The Warranty Period for all coverages begins on the date the vehicle is delivered to the first retail purchaser or first placed in service as a demonstrator or company vehicle.

BASIC COVERAGE

The basic Warranty Period is 12 months or 15,000 miles (24,135 kilometers), on the odometer, whichever occurs first. Winnebago Industries does not authorize any person to create for it any other obligations or liability in connection with this vehicle. ANY IMPLIED WARRANTY OF MERCHANTABILITY OR FITNESS FOR A PARTICULAR PURPOSE APPLICABLE TO THIS VEHICLE IS LIMITED IN DURATION TO THE DURATION OF THIS WRITTEN WARRANTY AS HEREINBEFORE OR HEREINAFTER PROVIDED. THE PERFORMANCE OF REPAIRS IS THE EXCLUSIVE REMEDY UNDER THIS WRITTEN WARRANTY OR ANY IMPLIED WARRANTY. WINNEBAGO INDUSTRIES SHALL NOT BE LIABLE FOR INCIDENTAL OR CONSEQUENTIAL DAMAGES FOR LOSS OF TIME, INCONVENIENCE, OR OTHER CONSEQUENTIAL DAMAGE INCLUDING EXPENSE FOR GASOLINE, TELEPHONE, TRAVEL, LODGING, LOSS OR DAMAGE TO PERSONAL PROPERTY, OR LOSS OF REVENUE RESULTING FROM BREACH OF THIS WRITTEN WARRANTY OR ANY IMPLIED WARRANTY. Some states do not allow limitations on how long an implied warranty will last or the exclusion or limitation of incidental or consequential damages, so the above limitations or exclusions may not apply to you.

ITEMS NOT SUBJECT TO WARRANTY COVERAGE.

Chassis, Drivetrain and related components*
Wheels*
Tires*
Service Items, such as Windshield Wiper Blades, Lubricants, Fluids & Filters
Adjustments

*These items are covered under the manufacturer's individual warranty.

This warranty gives you specific legal rights and you may also have other rights which vary from state to state.

Also, this warranty shall not apply to failures, damage or malfunctions resulting from normal wear, misuse, abuse, negligence, alteration, accident, fire, improper repair of the vehicle or failure to follow recommended maintenance requirements.

36 MONTHS/36,000 MILE STRUCTURAL WARRANTY

At the expiration of the Basic Coverage and for the remainder of the period of 36 months or 36,000 miles (57,924 kilometers), on the odometer, whichever occurs first, Winnebago Industries warrants the following:

1. Body Thermo-Panel® Lamination of the sidewalls and backwall against delamination. Body Thermo-Panel® Lamination is the bonding of the exterior skin and the interior paneling to an insulating core material. Delamination (separation of layers) caused by other factors such as physical damage or failure to properly maintain sealants is not covered by this warranty.
2. The slide-out room assembly for defects in material or workmanship.
3. Structural defects of the subfloor and floor. Floor lamination failure and lamination failure of the subfloor panels and risers are covered by the structural warranty.

PLACE
STAMP
HERE

Winnebago Industries, Inc.
P.O. Box 152
Forest City, Iowa 50436

ATTENTION: WARRANTY DEPT.

WINNEBAGO INDUSTRIES' RESPONSIBILITY

Any part of the vehicle subject to warranty which is found to be defective in material or workmanship, will be repaired or replaced at Winnebago Industries' option upon notice of the defect without charge to the customer for parts or labor. While any Winnebago Industries motor home dealer can perform warranty service, we recommend you return to the dealership that sold you your vehicle. If you are touring or have moved, contact any Winnebago Industries motor home dealer in the United States or Canada for warranty service.

CUSTOMER RESPONSIBILITY WHEN REPAIRS ARE NEEDED

If a part of the system covered by this warranty fails to function or requires service during the warranty period:

1. Promptly take the vehicle to the selling dealer for repair or inspection.
2. Written notice of defects must be given to the selling dealer or manufacturer no later than 10 days after the expiration of the warranty.
3. If the dealer is incapable of making the repairs, request that he contact Winnebago Industries, Inc.
4. If, after the above steps are completed and the repair is not made, the customer should contact Winnebago Industries, Inc., P.O. Box 152, Forest City, Iowa 50436, Attention: Owner Relations Department (800-537-1885) and furnish the following information:
 - The complete serial number of the vehicle
 - Date of retail purchase
 - Selling dealer's name
 - Nature of the service problem, and a brief explanation of the steps or service the dealer has performed, and the results obtained. The customer may be directed to another dealer or service center for repairs to be completed, if such a dealer or service center is better able to complete the repair.

Winnebago Industries may, at its option, request the vehicle be returned to Forest City, Iowa for repair. If the customer refuses to allow repairs to be performed at the Forest City, Iowa facility, the warranty on that repair will be voided.

5. If after the above steps are completed and the repairs are not satisfactory, the customer may contact the Service Administration Manager of Winnebago Industries, and request a customer relations board meeting to resolve the problem. This action, however, is not mandatory.
6. Certain components are covered beyond the 12 months/15,000 miles basic warranty coverage by the individual manufacturer's warranty. Please refer to the component's information supplied in the owner's information InfoCase for any additional warranty coverage after the basic warranty has expired.

DEALER'S REPRESENTATIONS EXCLUDED

Winnebago Industries, Inc. does not undertake the responsibility to any purchaser of its products for any undertaking, representation, or warranty made by dealers selling its product beyond those herein expressed.

INSTALLATION NOT COVERED

Winnebago Industries, Inc. cannot, however, and does not accept any responsibility in connection with any of its motor homes for additional equipment or accessories installed at any dealership or other place of business, or by any other party other than Winnebago Industries, Inc. Such installation of equipment or accessories by any other party will not be covered by the terms of this warranty.

CARE AND MAINTENANCE

It is the owner's responsibility to perform the care, maintenance and proper load distribution described in the owner's manual which accompanies your motor home. Any damage which results to your vehicle as a result of your failure to perform such duties, is not covered.

Damage to appearance items such as fiberglass, metal, paint, fabrics and trim, may occur during manufacturing or transporting. Normally, any factory defect or damage is corrected at the factory. In addition, dealers are obligated to inspect each vehicle upon delivery to them and prior to delivery to you. You should also immediately inspect appearance items and advise your selling dealer of any discrepancies. Damage and normal deterioration due to use and exposure is not covered by this warranty.

CHANGES IN DESIGN

Winnebago Industries, Inc. reserves the right to make changes in design and changes or improvements upon its products without imposing any obligation upon itself to install the same upon its products theretofore manufactured.

NEW YORK:

If your motor home has been repaired three or more times for the same nonconformity, defect, or condition, or if your motor home has been out of service by reason of repair for twenty-one days, Section 198-a of the General Business Law of the State of New York requires you to provide written notice by certified mail, return receipt requested, to Winnebago Industries or its authorized dealer before making any claim under that section of the law. If you do have problems with your motor home, you should provide written notice to Winnebago Industries at the following address:

Winnebago Industries, Inc.
 P.O. Box 152
 Forest City, Iowa 50436
 Atten: Owner Relations

PART NO. 701677-K2-004 5-03

-----CUT HERE-----

NOTICE OF SECOND OWNER

ORIGINAL OWNER	NAME	
	ADDRESS	
NEW OWNER	NAME	
	ADDRESS	ZIP CODE
WINNEBAGO INDUSTRIES IDENTIFICATION NUMBER	VEHICLE MILEAGE	DATE
CHASSIS IDENTIFICATION	NEW OWNER SIGNATURE	

IMPORTANT: THIS NOTICE IS TO BE USED ONLY FOR RECORD KEEPING BY WINNEBAGO INDUSTRIES
 The completed form does not constitute an actual change of ownership.

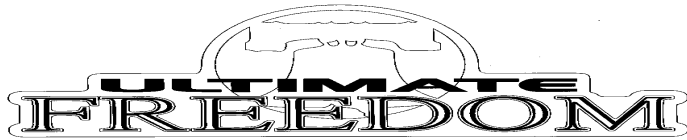

TABLE OF CONTENTS

INTRODUCTION

About this Manual	0- 1
Spartan Chassis Operating Guide	0- 1
Cummins Diesel Engine Manual	0- 1
Owner's InfoCase	0- 2
Before Driving	0- 2
Service and Assistance.....	0- 2
Warranty	0- 2
Drinking and Driving.....	0- 3
Reporting Safety Defects	0- 3
Vehicle Certification Label.....	0- 4
Exterior Feature Identification.....	0- 5

SECTION 1: SAFETY PRECAUTIONS

General Warnings	1- 1
Driving	1- 2
Fuel and LP Gas.....	1- 2
LP Gas Leaks	1- 3
LP Gas Alarm	1- 3
Electrical	1- 4
Loading	1- 4
Maintenance.....	1- 5
Formaldehyde Information	1- 5
Carbon Monoxide Warning	1- 5
Carbon Monoxide Alarm	1- 6
Emergency Exits	1- 6
Fire Extinguisher.....	1- 7
Smoke Alarm	1- 7

SECTION 2: DRIVING YOUR MOTOR HOME

Before Entering Your Vehicle	2- 1
Before Driving Your Vehicle	2- 1
Fuel Selection	2- 2
Starting and Stopping Engine	2- 2
Engine Block Heater	2- 3
Parking Brakes.....	2- 3
Jacobs Extarder Engine Exhaust Braking System.....	2- 4
Hazard Warning Lights.....	2- 5
Signal Lever/Headlight Hi/Lo Beam	2- 5
Entrance Door Lock and Handle.....	2- 8
Power Door Lock.....	2- 9
Keyless Remote Entry System.....	2- 9
Electric Entrance Step.....	2- 10
Stepwell Cover.....	2- 11
Luggage Compartment Doors.....	2- 11

Power Electric Mirrors.....	2- 12
Driver Seat	2- 16
Seat Belts	2- 17
Child Restraints.....	2- 18
Comfort Controls	2- 21
Antenna Check Light	2- 22
Stereo Sound System	2- 22
CB Radio Wiring	2- 23
Slideout Room Extension	2- 26

SECTION 3: IN CASE OF DRIVING

EMERGENCY

Hazard Warning Flasher	3- 1
Recovery Towing.....	3- 1
Jump Starting	3- 2
Connecting Jumper Cables	3- 2
Connecting A Battery Charger	3- 3
Engine Overhead.....	3- 3

SECTION 4: TRAVELING WITH YOUR MOTOR HOME

Loading the Vehicle.....	4- 1
Front Axle Tire Alignment	4- 1
Weighing Your Loaded Vehicle	4- 1
Maximum Occupancy.....	4- 3
Roof Loading	4- 3
Car or Trailer Towing.....	4- 3
Pre-Travel Check List.....	4- 4
Travel Tips.....	4- 5
Severe Weather Information.....	4- 6
Nighttime Driving.....	4- 7
Mountain Driving	4- 7
Campsite Selection	4- 7
Leveling	4- 7
Effects of Prolonged Occupancy	4- 8
Humidity and Condensation	4- 8

SECTION 5: LP GAS SYSTEM

LP Gas Supply	5- 1
Safe Use of the LP Gas System	5- 1
How LP Gas Works	5- 1
Selecting LP Fuel Types	5- 2
LP Tank System.....	5- 2
Air in the LP Gas Tank	5- 3
Regulator.....	5- 4
LP Gas Leaks	5- 4
Winter Use of LP Gas	5- 5



SECTION 6: ELECTRICAL SYSTEMS

110-Volt AC System..... 6- 1
External Power Cord (Shoreline)..... 6- 1
Powerline Energy Management System
(EMS)..... 6- 3
Power Converter System 6- 3
Inverter/Charger and Circuit Breaker
Locations..... 6- 4
110-Volt Circuit Breakers..... 6- 5
Thermal Overload Protector 6- 5
110-Volt Receptacles..... 6- 6
Ground Fault Circuit Interrupter..... 6- 6
Auxiliary 110-Volt Generator..... 6- 6
Operation Warnings and Cautions..... 6- 8
12-Volt DC System..... 6- 10
Solar Charger Panel 6- 10
Battery Information..... 6- 11
House Batteries 6- 11
Battery Storage and Maintenance 6- 12
Trailer Wiring Connector..... 6- 13

SECTION 7: PLUMBING SYSTEMS

Fresh Water System 7- 1
Water Pump 7- 2
Accumulator Tank 7- 3
Disinfecting of Fresh Water System..... 7- 4
External Water Supply..... 7- 4
Water Purifier (Filter) System 7- 5
Shower Hose Vacuum Breaker..... 7- 6
Exterior Shower 7- 6
Waste Water System (Holding Tanks) 7- 6
Dumping Holding Tanks 7- 7
Using On-Site Sewer Hook-Ups..... 7- 8
Utility Light 7- 8
Tank Monitor Panel 7- 8
Water Drain Valves 7- 8
Tank Capacities..... 7- 9

SECTION 8: APPLIANCES AND INTERIOR FEATURES

Refrigerator..... 8- 1
Microwave/Convection Oven..... 8- 7
Range Hood 8- 7
OnePlace Systems Monitor Panel..... 8- 7
Dishwasher..... 8- 9
Washer-Dryer..... 8- 10
Hydronic Heating System..... 8- 10
Gas/Electric Water Heater 8- 12
Electronic Thermostat..... 8- 13
TV Antenna..... 8- 17

Antenna Signal Amplifier..... 8- 17
Digital Satellite Television System..... 8- 18
Video Selector System..... 8- 18
Exterior Entertainment Center 8- 20
Cable TV and Phone Hook-Ups 8- 21
Central Vacuum Cleaner..... 8- 21
Bedroom Radio 8- 22
Table and Chairs 8- 23
Dinette Chairs 8- 23
Sleeping Facilities..... 8- 24
Sleep Number Bed..... 8- 24
Rest Easy Multi-Position Lounge..... 8- 26
Banquette Sofa..... 8- 28
Fresh Water Toilet 8- 29
Power Roof Vent 8- 29
Slider Windows..... 8- 30

SECTION 9: CARE AND MAINTENANCE

Roof 9- 1
Underbody 9- 1
Exterior 9- 1
Care of Stripes and Decals..... 9- 2
Upholstery, Carpeting and Draperies..... 9- 2
Vinyl Wallboard 9- 5
Range and Refrigerator..... 9- 6
Bathroom 9- 6
Doors and Windows..... 9- 6
Vehicle Maintenance 9- 6
Rear Engine Grille 9- 6
Engine Cooling System 9- 8
Tires 9- 8
Suspension Alignment and Tire Balance..... 9- 9
Loading the Vehicle..... 9- 9
Windshield Washers and Wipers..... 9- 9
Lights 9- 9
Automotive 12-Volt Fuses and
Circuit Breakers 9- 10

SECTION 10: STORING YOUR MOTOR HOME

Preparing Vehicle for Storage..... 10- 1
Cold Weather Storage Procedure
(Winterizing)..... 10- 1
RV Antifreeze Water Line Winterization
Systems 10- 4
Removal from Storage 10- 6



INTRODUCTION



Congratulations on the purchase of your new Ultimate Freedom motor home, which has been carefully designed, engineered and quality built by Winnebago Industries, Inc.



ABOUT THIS MANUAL

Please read this operator's manual completely to understand how everything in your coach works before taking it on its "maiden voyage."

This manual is a guide to safe operation of the features, equipment and controls in this coach. Some equipment, such as the vehicle chassis and certain electronic systems or appliances, have their own comprehensive, manufacturer supplied manuals or information sheets which describe operation of these products in great detail. This manual will refer you to the manufacturer's information included in your Owner *INFOCASE* whenever necessary.

SUBJECT ICONS - To make it easy for you to find information you're looking for, we have placed convenient, pictorial symbols called "icons" beside many of the subject headings in this manual. The icons correspond to the subject matter of the section. These icons were designed similar to the familiar international symbols which identify public facilities such as restrooms and handicap access. There are several examples of icons on this page.

PAGE ICONS - The icons at the upper corners of each page correspond to the primary content of each main section of the manual, such as LP Gas, Electrical, Plumbing, etc. This means you can flip through the manual either forward or backward and know exactly which main section you are looking for just by watching the icons at the top of the page. This means less paging back and forth.

We also urge you to read the complete Chassis Operating Guide provided by the chassis maker and all other operating information provided by our equipment suppliers and manufacturers. This is contained in your Owner *INFOCASE*.

This manual should be kept in the vehicle at all times for personal reference. The operator's manual, *INFOCASE* and chassis operating guide are to be considered permanent components of this vehicle. They should remain in the vehicle when sold to provide the next owner with important safety, operating and maintenance information.

NOTE: The descriptions, illustrations, and specifications in this manual were correct at the time of printing. We reserve the right to change specifications or design without notice, and without incurring obligation to install the same on products previously manufactured.

SPARTAN CHASSIS OPERATING GUIDE

Throughout this manual, frequent reference is made to the vehicle chassis operating guide. The chassis guide is the operator's manual provided by Spartan, the manufacturer of the chassis on which this motor home is built. Consult the chassis guide for operating safety and maintenance instructions pertaining to the chassis section of the motor home.

CUMMINS DIESEL ENGINE MANUAL

The diesel engine in your coach is built by the respected Cummins engine company. Consult the Cummins Operation and Maintenance Manual for information on all engine related topics such as engine maintenance, fluid level checks, capacities, and service parts, etc.



INTRODUCTION

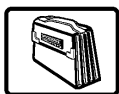

OWNER'S INFOCASE

Your InfoCase contains information supplied by manufacturers of individual appliances and equipment installed in your motor home.

Consult this information regarding the operation and care of appliances, accessories and special equipment.

OPTIONS AND EQUIPMENT

Some equipment described in this manual may not apply to your coach.



BEFORE DRIVING

Before sitting in the driver's seat, always check around your vehicle to be sure you have proper clearance for maneuvering. If necessary, have a passenger help guide you out of a difficult parking space.

Although your coach features automotive conveniences like power steering and power brakes, driving a motor home is different from driving a car. A motor home is larger and heavier than an automobile, so it requires more stopping and passing distance, and more parking and maneuvering space than a car does.



Always be aware of the size of your motor home. The added height of rooftop accessories or luggage boxes may cause clearance problems around some tunnels, canopies and hanging

signs. Know the height of your coach so you can observe posted clearance limits. Also, remember that some bridges, old ones in particular, may not support the weight of your motor home. Know the weight of your unit and observe any posted weight limits.

Remember: Always use your seat belt and be sure your passengers do so as well. We also advise making frequent rest stops while traveling to relieve stress on yourself, your passengers and your vehicle.

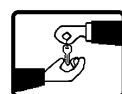

SERVICE AND ASSISTANCE

Your Ultimate Freedom dealer will be glad to provide any additional information you need, as well as answer any questions you might have about operating the equipment in your motor home. When it comes to service, remember that your dealer knows your vehicle best and is interested in your satisfaction. Your dealer will provide quality maintenance and any other assistance that you may require during your ownership of this vehicle.

If you need warranty repairs while traveling, you may take your motor home to any Winnebago or Itasca dealership and they will assist you.



WARRANTY

Your new Ultimate Freedom is covered by a factory warranty against defects in material and workmanship. This warranty should be validated immediately and returned to the factory by your dealer. For additional information, see your "New Vehicle Limited Warranty" included with this vehicle.



DRINKING AND DRIVING

Winnebago Industries supports the recommendations of the Presidential Commission on Drunk Driving.

- Exercise your good judgment and encourage others to do the same.
- Know the legal limits and do not exceed them.
- Also know your personal limits, which may be lower than the legal limits.
- Should you ever exceed your limits, find alternative transportation; call a cab, ask a friend to drive you home or call a family member to come and get you.

The presence of alcohol in significant levels in the blood increases the probability that the driver will be involved in an accident.

REPORTING SAFETY DEFECTS

If you believe that your vehicle has a defect which could cause a crash or could cause injury or death, you should immediately inform the National Highway Traffic Safety Administration (NHTSA) in addition to notifying Winnebago Industries, Inc.

If NHTSA receives similar complaints, it may open an investigation, and if it finds that a safety defect exists in a group of vehicles, it may order a recall and remedy campaign. However, NHTSA cannot become involved in individual problems between you, your dealer, or Winnebago Industries.

To contact NHTSA, you may either call the Auto Safety Hotline toll-free at 1-800-424-9393 (or 366-0123 in Washington, D.C. area) or write to: NHTSA, U.S. Department of Transportation, Washington, D.C. 20590. You can also obtain other information about motor vehicle safety from the Hotline.



VEHICLE CERTIFICATION LABEL

This label contains vehicle identification and other important reference information. The vehicle certification label is located on the sidewall to

the left of the steering wheel. Never remove or destroy this label.

MANUFACTURED BY		INCOMPLETE VEHICLE MANUFACTURED BY	
		BY ① MOTOR CORP.	
③		MONTH AND YEAR OF MANUFACTURE: ②	
GAWR: ⑤		GVWR ④ LB _____ KG	
FRT LB _____ KG		SUITABLE TIRE AND RIM CHOICE	
RR. ⑤ LB _____ KG		TIRE _____ RIM _____	
		COLD INFLATION PRESSURE	
		PSI _____ KPA SINGLE	
		⑧ PSI _____ KPA ⑨	
THIS VEHICLE CONFORMS TO ALL APPLICABLE FEDERAL MOTOR VEHICLE SAFETY STANDARDS IN EFFECT ON THE DATE OF MANUFACTURE SHOWN ABOVE.			
SERIAL NO. ⑩		VIN _____ ⑪	
TYPE _____ ⑫		MODEL _____ ⑬ COLOR _____ ⑭	

EXPLANATION OF DATA

1. Chassis manufacturer.
2. Chassis manufacture date.
3. Month and year of manufacture at Winnebago Industries.
4. Gross Vehicle Weight Rating: Total permissible weight of the vehicle, including driver, passengers, total cargo carried (including all liquids) and equipped with all options.
5. Gross Axle Weight Rating: Total permissible weight allowed for the front and rear axles (listed in pounds and kilograms).
6. Suitable Tire Choice: Tires recommended to meet handling and safety requirements. When replacing any of the tires on your vehicle, always replace with a tire that meets these specifications.
7. Suitable Rim Choice: Wheel rims recommended to meet handling and safety requirements. When replacing any of the rims on your vehicle, always replace with a rim that meets these specifications.
8. Cold Inflation Pressure: Inflation pressures recommended (while Cold) for the tires originally equipped on your vehicle. These pressure levels must be maintained to assure proper handling, safety and fuel economy.
9. Rear Axle Wheel Configuration: Single or Dual.
10. Serial Number: This is the serial number assigned to the completed vehicle by Winnebago Industries.
11. Vehicle Identification Number (VIN): This number identifies the chassis on which the motor home is built. The 10th digit of the VIN designates the chassis model year. (3=2003, 4=2004) This information is useful when ordering chassis repair parts.
12. Type: States the NHTSA designated usage classification for your motor home. MPV signifies a Multi-purpose Passenger Vehicle.
13. Model: Lists the Winnebago product model number of your vehicle.
14. Color: Signifies the color code number of the decor used throughout the vehicle. This number is necessary for ordering replacement cushions, curtains, carpet, etc.



EXTERIOR FEATURE IDENTIFICATION

Composite model shown for illustration purposes only.
Actual locations of features depends on coach model and options.

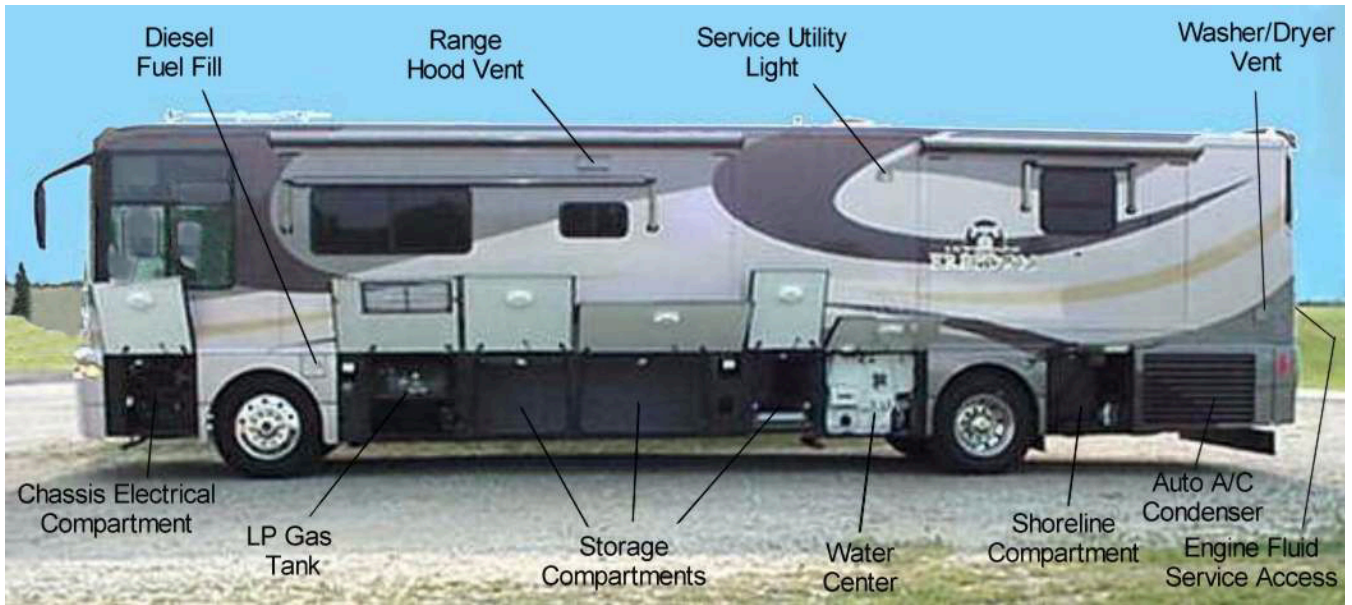

NOTE: Some equipment shown may be optional.



SECTION 1

SAFETY PRECAUTIONS



About Safety Messages Used in This Manual

Throughout this manual, certain items are labeled Note, Caution, Warning or Danger. These terms alert you to precautions that may involve damage to your vehicle or a risk to your personal safety. Read and follow them carefully.



This SAFETY ALERT SYMBOL is used to draw your attention to issues which could involve potential personal injury. This symbol is used throughout this manual and/or on labels affixed on or near various equipment in this motor home.

 **DANGER**

DANGER indicates a directly hazardous situation which, if not avoided, will result in death or serious personal injury.

 **WARNING**

WARNING indicates a potentially hazardous situation which, if not avoided, could result in death or serious personal injury.

 **CAUTION**

CAUTION indicates a potentially hazardous situation which, if not avoided, could result in damage mainly to equipment or property, but in some cases may also result in minor or moderate personal injury.

NOTE: A 'Note' is not necessarily safety related but indicates a recommendation or special point of information that could assist in understanding the use or care of a feature item.

The following pages provide safety precautions that must be adhered to. These precautions as well as others that involve possible injury or damage to equipment are also displayed in the appropriate areas in this manual.



GENERAL WARNINGS

- Only seats equipped with seat belts are to be occupied while the vehicle is moving.
- All seats which can be positioned, such as swiveling, sliding, reclining, or footrest out, must be placed in a fully upright and swivel-locked position with footrests retracted while the vehicle is moving. Some swivel lounge chairs are designed to lock in a forward facing position, while others lock in an aisle facing position. Be certain these seats are secure from swiveling before traveling.
- Make sure all passengers have seat belts fastened in a low and snug position so the force exerted by the belt in a collision will be spread across the strong hip area. Pregnant women should wear a lap-shoulder belt whenever possible, with the lap belt portion worn low and snug throughout the pregnancy.
- Before driving, secure dinette chairs with retainer strap provided as shown in Section 8.
- Never let passengers stand or kneel on seats while the vehicle is moving.
- Sleeping facilities are not to be utilized while vehicle is moving.
- Examine the escape window and be familiar with its operation, but do not use except in an emergency.
- Inspect the fire extinguisher monthly for proper charge and operating condition. This



SECTION 1 SAFETY PRECAUTIONS



should also be done before beginning a vacation or any extended trip.



DRIVING

- Do not attempt to adjust the driver's seat while the vehicle is moving.
- Do not adjust tilt steering in a moving vehicle.
- Do not operate the cruise control on icy or extremely wet roads, winding roads, in heavy traffic, or in any other traffic situation where a constant speed cannot be maintained.
- Use care when accelerating or decelerating on a slippery surface. Abrupt speed changes can cause skidding and loss of control.
- Driving through water deep enough to wet the brakes may affect stopping distance or cause the vehicle to pull to one side. Check brake operation in a safe area to be sure they have not been affected. Never operate any vehicle if a difference in braking efficiency is noticeable.
- Adverse weather conditions and extremes in terrain may affect handling and/or performance of your vehicle. Refer to your chassis manual for related information.

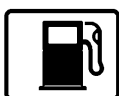

FUEL & LP GAS



- All pilot lights must be extinguished and appliances turned off while refilling the fuel tank or LP tank.
- Never smoke while refilling vehicle fuel tank or LP gas tank.

- Avoid inhaling exhaust gases produced by burned gasoline, diesel fuel or LP gas in items such as the range, chassis engine, generator engine, refrigerator, furnace and water heater. They contain carbon monoxide, which is an odorless, colorless and poisonous gas.
- Do not bring or store LP gas containers, gasoline or other flammable liquids inside the vehicle because a fire or explosion may result. LP gas containers are equipped with safety valves which relieve excessive pressure by discharging gas to the atmosphere.
- Do not alter the LP gas system at any time or in any way.
- Do not fill LP gas container(s) above 80 percent of capacity. Overfilling the LP gas container can result in uncontrolled gas flow which can cause fire or explosion. A properly filled container will contain approximately 80 percent of its volume as liquid LP gas.
- Never use an open flame to test for LP gas leaks. Replace all protective covers and caps on LP system after filling. Make sure valve is closed and door latched securely.
- Never connect natural gas to the LP gas system.
- When lighting range burners do not turn burner controls to "On" and allow gas to escape before lighting match.
- Portable fuel-burning equipment, including wood and charcoal grills and stoves, shall not be used inside the recreational vehicle. The use of this equipment inside the recreational vehicle may cause fires or asphyxiation.
- LP gas regulators must always be installed with the diaphragm vent facing downward. Regulators are equipped with a protective cover. Make sure that the regulator vent faces downward and that the cover is kept in place to minimize vent blockage which could result in excessive gas pressure causing fire or explosion.



- The following warning label is located in the cooking area to remind you to provide an adequate supply of fresh air for combustion.

⚠ WARNING

IT IS NOT SAFE TO USE
COOKING APPLIANCES
FOR COMFORT HEATING

Cooking appliances need fresh air for safe operation. Before operation

1. Open overhead vent or turn on exhaust fan.
2. Open window

FAILURE TO COMPLY COULD RESULT IN
DEATH OR SERIOUS INJURY.

Unlike large homes, the oxygen supply inside a recreational vehicle is limited due to its size. To avoid danger of asphyxiation, provide proper ventilation when using the gas rangetop or gas oven. It is especially important that the gas oven and range top not be used for comfort heating. Danger of asphyxiation is greater when these appliances are used for long periods of time.



LP GAS LEAKS

The following label is located in the vehicle near the range area. If you smell gas within the vehicle, quickly and carefully perform the procedures listed.

⚠ DANGER

IF YOU SMELL GAS

1. EXTINGUISH ANY OPEN FLAME, PILOT LIGHTS AND ALL SMOKING MATERIALS.
2. DO NOT TOUCH ELECTRICAL SWITCHES.
3. SHUT OFF THE GAS SUPPLY AT THE TANK VALVE(S) OR GAS SUPPLY CONNECTIONS.
4. OPEN DOORS AND OTHER VENTILATING OPENINGS.
5. LEAVE THE AREA UNTIL ODOR CLEARS.
6. HAVE THE GAS SYSTEM CHECKED AND LEAKAGE SOURCE CORRECTED BEFORE USING AGAIN.

FAILURE TO COMPLY COULD RESULT IN
EXPLOSION RESULTING IN DEATH OR
SERIOUS INJURY.



LP GAS ALARM

Your coach is equipped with an LP gas detector which sounds an alarm if an unsafe amount of LP gas is present inside the coach. Because LP gas is heavier than air, the detector is located on a cabinet face near the floor of the coach.



A green light on the face of the alarm shows when the unit is active. The red button is used to reset the alarm.

Press to stop alarm

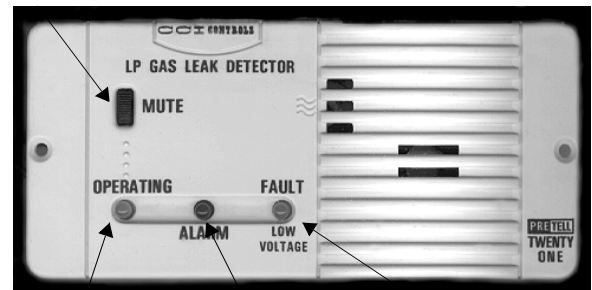

Green (Active) Red (Alarm) Amber (Low Batt.)

If The Alarm Sounds

If the alarm sounds, do not touch any electrical switches. Immediately turn off the main LP tank valve and all LP appliances, open all windows and roof vents, and leave the coach until the alarm stops sounding.

If the alarm keeps sounding at regular intervals, a leak may be present. Contact your dealer or an LP gas service center to have the problem corrected before using the LP system again.



SECTION 1 SAFETY PRECAUTIONS



If the coach batteries become extremely drained, an amber light on the face of the alarm will come on and in some cases the LP alarm may begin to sound on its own. This condition typically occurs only during storage periods when the house battery will not be charged regularly by the engine or shoreline. To avoid battery discharge we recommend turning the Aux Batt switch off during storage periods and after periodic or weekend usage.



WARNING

Never use an open flame to test for gas leaks. When testing for gas line leaks with a soapy water solution, DO NOT use a detergent containing ammonia or chlorine. These substances may generate a chemical reaction causing corrosion to gas lines, resulting in dangerous leak conditions.

Power Connection

The gas alarm is powered by the coach batteries. If the battery cable is disconnected from the batteries, auxiliary battery switch is shut off, or the circuit breaker is tripped, the alarm will not work. The LP gas alarm breaker is located on the coach breaker fuse panel shown in Section 6.

Because the LP gas alarm is connected directly to the auxiliary battery, it is always drawing a small amount of current. Even though this current draw is slight, it could drain the coach battery. If this happens, connect the shoreline to 110-volt supply to recharge the house batteries.

Further Information

See the manufacturer's information entitled "Your LP Gas Detector" in the Owners InfoCase for further instructions on nuisance alarms and care and testing of the LP gas detector.



ELECTRICAL

- Careless handling of electrical components can be fatal. Never touch or use electrical components or appliances while feet are bare, while hands are wet, or while standing in water or on wet ground.
- Improper grounding of the vehicle can cause personal injury. Do not plug the utility power cord into an outlet which is not grounded and do not adapt the plug to connect to a receptacle for which it is not designed.
- Do not attach an extension cord to the utility power cord.
- Be sure that all electrical appliances to be used contain 3-prong plugs for proper grounding.
- Avoid overloading electrical circuits. Replace fuses or circuit breakers with those of the same size and amperage rating only. Never use a higher rated fuse or breaker.
- Use caution when handling or working near electrical storage batteries. Always remove jewelry and wear protective clothing and eye covering. Avoid creating sparks.

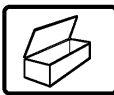

LOADING

- Store or secure all loose items inside the motor home before traveling. Possible overlooked items such as canned goods or small appliances on the countertop, cooking pans on the range, or free-standing furniture items can become dangerous projectiles during a sudden stop or evasive maneuver.
- Be aware of GVWR, GAWR and individual load limit on each tire or set of duals. (See "Loading the Vehicle" in Section 4.)
- Never load the motor home in excess of the gross vehicle weight rating or the gross axle weight rating for either axle.



NOTE: *Your motor home's load capacity is designated by weight, not by volume, so you cannot necessarily use all available space when loading your motor home.*



MAINTENANCE

- Do not remove the radiator cap while engine and radiator are still hot. Always check coolant level visually at the see-through coolant reservoir.
- Never get beneath a vehicle that is held up by a jack.
- Do not mix different construction types of tires on the vehicle such as radial, bias or belted tires, as vehicle handling may be affected. Replace tires with exact size, type and load range.
- Do not attempt to start the vehicle by hot wiring.

FORMALDEHYDE INFORMATION

WARNING

Some components in this vehicle contain formaldehyde based adhesives which may release formaldehyde fumes into the air for an unknown period of time until total dissipation occurs. Individuals who are allergic to formaldehyde gas fumes may experience irritation to eyes, ears, nose and throat. Reaction in infants may be more severe. Although long range effects are not well understood, testing to date has not revealed any serious health effects in humans at the level of emission from these products.

IMPORTANT

To aid in dissipation, ventilate the vehicle by opening all windows and circulating the air with a fan.

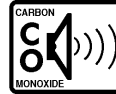

CARBON MONOXIDE WARNING

WARNING

Avoid inhaling exhaust gases, as they contain carbon monoxide, which is a colorless, odorless and poisonous gas.

If you suspect that exhaust fumes are entering the passenger compartment, have the cause determined and corrected as soon as possible. If you must drive under these conditions, drive only with **ALL WINDOWS FULLY OPENED**.

The best protection against carbon monoxide entry into the vehicle body is a properly maintained engine exhaust and ventilation system. It is recommended that the exhaust system and body be inspected by a qualified motor home service center.

- Each time the vehicle is raised for an oil change.
- Whenever a change in the sound of the exhaust system is noticed.
- Whenever the exhaust system, underbody or rear of the vehicle is damaged.

To allow proper operation of the vehicle's ventilation system, keep front ventilation inlet grill clear of snow, leaves or other obstructions at all times. **DO NOT OCCUPY A PARKED VEHICLE WITH ENGINE RUNNING FOR AN EXTENDED PERIOD.**

Do not run engine in confined areas, such as a garage, except to move vehicle in or out of area. When vehicle is stopped in an **UNCONFINED** area with the engine running for any more than a short period, adjust heating or cooling system to force outside air into the vehicle as follows:



SECTION 1 SAFETY PRECAUTIONS



1. Set fan to medium or high speed and vent control to air.
2. On vehicles equipped with air conditioning, set fan to medium or high speed and set control to obtain maximum vent air.

Rear windows should be closed while driving to avoid drawing dangerous exhaust gases into the vehicle.

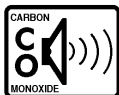

CARBON MONOXIDE ALARM

Your coach is equipped with a carbon monoxide (CO) alarm, located on the ceiling in the bedroom area.

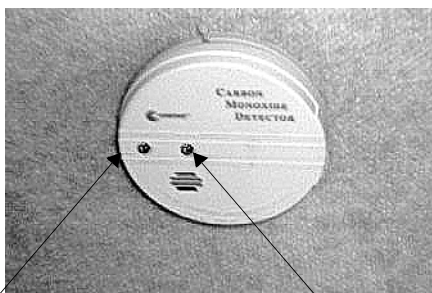

Red Light
(Press to Test Alarm)

Yellow Light
(Warning)

The CO alarm is powered by a 9-volt battery and contains a sensor that is designed to detect toxic carbon monoxide gas fumes resulting from incomplete combustion of fuel. It will detect CO gas from any combustion source such as the furnace, gas range/oven, water heater, refrigerator, chassis engine, and electric generator engine.

- Patented biomimetic sensor mimics the human response to Carbon Monoxide.
- Test/Reset provides for one time alarm silence and multiple warning silence. Also tests alarm circuitry, microprocessor, battery and horn.
- Red light flashes once every thirty seconds in normal operation.
- Continuous yellow light with a beep every three seconds indicates an unhealthy CO level.
- Continuous red light and pulsating alarm signal a dangerous CO condition.

- Battery operation provides protection 100% of the time. Low battery signal alerts consumer of need to replace battery.
- 85 decibel alarm assures waking during sleeping hours.

Monthly Testing

Press the TEST button on the face of the alarm periodically (at least monthly) to check the function of the alarm and condition of the battery. If the alarm begins to beep every few seconds, the battery may be weak and need replacement. (Press the TEST button to be sure before replacing the battery. If the alarm sounds, the battery may still be okay. If the alarm still beeps every few seconds, check the smoke detector also. The “low battery” warning beep is similar on many alarm devices, so the origin of this electronic sound can be deceiving.)

Further Information

Please read the information provided by the manufacturer, which is included in your Owner’s InfoCase. It includes information on precautions, operational testing, and battery/sensor replacement.



EMERGENCY EXITS Emergency Exit Windows

Your motor home is equipped with an emergency exit window on the left (driver’s) side of the bedroom which functions as an escape exit in an emergency situation.



WARNING

Use emergency window for emergency exit only. Do not test for proper operation.

Use care when exiting emergency window, as broken glass may be present in the exit area.



The side mounted escape window is secured by two safety latches and can be opened by first releasing these two latches and then pushing outward on the lower part of the window. Identify which type of emergency exit window is in your vehicle.

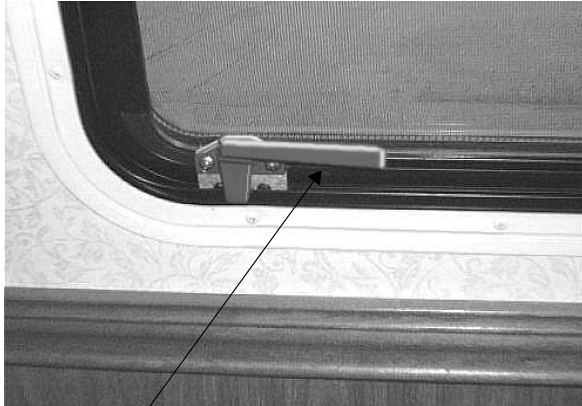

Lift Both Handles Up
Push Out on Bottom of Window

Instructions for removal are also located on a label on the glass for quick reference and for passengers who may not be familiar with the exit. Never remove or destroy this label.

Using Slider Windows as Emergency Exits

Slider windows along the side of the motor home can also be used as emergency exits, should the need arise. To use the windows as exits, slide the window open, then slide the screen open.

SAFETY DEVICES



FIRE EXTINGUISHER

A dry chemical fire extinguisher is located near the floor behind the passenger seat.



We recommend that you become thoroughly familiar with the operating instructions displayed on the side of the fire extinguisher or in the information supplied in your Owner's InfoCase.

We also recommend that you inspect the fire extinguisher for proper charge at least once a month in accordance with National Fire Protection Association (NFPA) recommendations as stated on the label. If the charge is insufficient, the fire extinguisher must be replaced.

WARNING

Do not test the fire extinguisher by discharging it. Partial discharge can cause leakage of pressure or contents which would render the unit inoperative when needed. When using the fire extinguisher, aim the spray at the base of the fire.



SMOKE ALARM

Your motor home is equipped with a smoke alarm located on the ceiling in the galley and lounge area. This alarm meets U.L. Standard 217 and NFPA Standard 74 for operation of smoke detection devices.



SECTION 1 SAFETY PRECAUTIONS



See your Owner's InfoCase for further information.



1. The smoke alarm should be tested for correct operation each time the vehicle is brought out of storage, before each trip, and at least once a week during motor home use. To test the electronics, firmly depress the button. To test that smoke reaches the sensor, blow smoke in a careful, fire-safe manner into your smoke alarm.

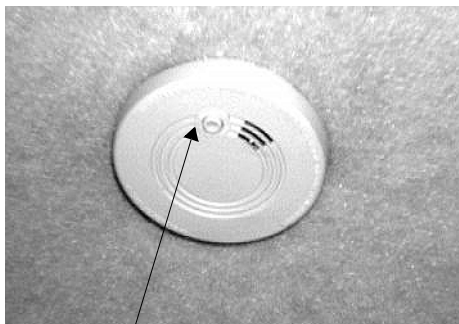

Press to Test

2. Your smoke alarm will not work without power. Never remove the battery to quiet the alarm. When your smoke alarm "beeps" about once a minute the battery is weak. Install a new battery immediately. Be sure to use only batteries specified in manual or on unit. Test unit after installing a new battery.
3. Clean and vacuum the openings on your smoke alarm once a month. Do not open the smoke alarm or try to repair it. For replacement information see warranty in Owner's Manual.
4. Smoke alarms have technical limitations and may not respond in all situations. FIRE PREVENTION is your best safeguard.

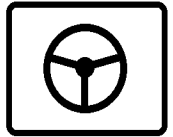

(See also Safety Precautions, Section 1 of this manual.)

NOTE: See your Spartan chassis operator's manual for information on starting the engine, operating the transmission, steering column controls descriptions of instrument gauges and other chassis related information.

Some items described in this section may be optional or unavailable on your coach.



BEFORE ENTERING YOUR VEHICLE

Before entering your vehicle, there are a few recommended procedures that will aid in your driving safety and equipment.

1. Be sure that the windows, mirrors and light lenses are clean and unobstructed.
2. Make sure all exterior lights operate properly.
3. Check tires for proper cold inflation pressures and inspect for any unusual wear.
4. Check wheel lug nuts for tightness.
5. Look beneath the vehicle for noticeable fluid leakage.
6. Check fluid levels and fill if necessary. This includes engine oil, transmission fluid, coolant, brake fluid, power steering fluid and windshield washer solvent.

 **WARNING**

The engine should be shut off unless specifically required for a certain procedure.

The transmission must be in N (Neutral) and park brake applied while performing any checks or adjustments.

7. Unhook and store sewer and water supply hoses.
8. Retract step.
9. Be sure that all of your cargo is secured before traveling. Be aware of loose items on tables or countertops, or free-standing furniture items that could become dangerous projectiles during a sudden stop or evasive maneuver.
10. Check around your vehicle in all directions to assure that you have proper clearance.
11. Lower TV antenna and satellite dish.
12. Disconnect and store shoreline.

 **WARNING**

Before driving your vehicle, be sure you have read the entire operator's manual and that you understand your vehicle's equipment completely and how to use the equipment safely.



BEFORE DRIVING YOUR VEHICLE

Before preparing to drive your vehicle, here are a few recommended procedures that will add to your driving safety and enjoyment.



1. Be sure that you adjust the interior and exterior rear view mirrors to your driving preference.
2. Adjust the driver's seat for proper distance from foot pedals and steering wheel to allow for safety and ease in controlling your vehicle.
3. Place front seats in the forward facing position.
4. Be sure to fasten all safety belts to fit you comfortably, but tight enough to obtain the full safety of the belts.
5. Make sure all doors are completely shut and locked. When the doors are shut and locked, there is less chance of the doors flying open in event of an accident. It also prevents unintentional opening of doors and keeps intruders out of your vehicle.
6. Check to see that all gauges are operating properly.
7. Check the fuel level in the vehicle.
8. Be certain that the fire extinguisher is fully charged and secure in its mounting bracket.

 CAUTION
Be sure hood and all compartment doors are latched securely before driving vehicle.

“KEY ONE” LOCK SYSTEM

(See also Power Door Lock, pg. 2-8)

Your coach is equipped with the new Key One™ lock system. A single key will open every door lock in the entire motor home (except the security deadbolt lock on the entrance door). This means you don't have to sort through a handful of keys to find the right one for the water fill door or the luggage doors or the entrance door or the driver's door.

The key number for your coach is registered in our factory database, so if you ever lose your keys, any Winnebago Industries dealership can easily order a new key for you. They are also equipped with special master keys and can unlock your coach for you if needed.



FUEL SELECTION

Refer to your Spartan chassis operating guide for the manufacturer's recommendations on proper fuel selection.

Winter Fuel Waxing and Anti-Gel Additives

In sub-freezing temperatures, #2 diesel fuel can form small wax crystals that become trapped in the fuel filter and block the fuel flow to the engine, causing it to stall out. At sub-zero temperatures, the fuel can congeal and turn “slushy”. If this happens, the only remedy is to have the vehicle towed into a heated facility to allow the fuel to warm up and become fully liquid again.

During winter time, most truck stops and reputable filling stations have winter blend diesel fuels available that are less susceptible to waxing.

There are also commercially available products, typically called anti-gel additives, to add to diesel fuel while filling the tank to inhibit wax formation in freezing temperatures.

Consult your Spartan chassis guide or Cummins engine guide for more information on fuel requirements and additives.

FILLING THE FUEL TANK

Diesel fuel, especially #2 grade, can foam up while being pumped into the tank. Sometimes this foam can cause the pump nozzle to shut off before the tank is actually full. Allow the foam to settle then resume filling at a slower flow rate until the tank is full.

Diesel Fuel Tank Capacity100 gal. diesel (single tank w/dual fills)



STARTING AND STOPPING ENGINE

Refer to your Spartan chassis operating guide for the manufacturer's recommendations on starting and stopping the engine.

See also “Engine Block Heater” elsewhere in this section.

Idling Diesel Engine

 **CAUTION**

The Cummins diesel engine must be set to 1000 rpm fast idle mode if idling for more than 10 minutes or the engine will be severely damaged.

To Increase Idle Speed: While idling, press the Cruise Control ON button, then press the SET button momentarily. This will automatically set the engine idle speed to 1000 rpm. The engine idle speed can be increased (or ‘ramped up’) by holding the SET button and releasing at the desired rpm speed - anywhere from 1000 rpm to a maximum of 1700 rpm.

To Decrease Idle Speed: Press the Cruise Control RES button momentarily to ‘bump down’ rpm’s in preset increments, or press and hold to ‘ramp down’ to 1000 rpm..

To Cancel High Idle: Press the Brake pedal to return to normal engine idle speed - especially before shifting the transmission when you are ready to drive off. You can also do this by pressing the cruise control On/Off or Cancel buttons.

Cold Weather Starting: Please note the following cold weather starting precautions. These labels are also located in appropriate areas of the coach. Failure to follow these precautions could cause serious damage to your diesel engine.

WARNING

DO NOT USE ETHER
OR STARTING FLUID

INTAKE MANIFOLD HEATER
MAY CAUSE EXPLOSION
AND SEVERE INJURY.



ENGINE BLOCK HEATER

Your coach is equipped with an engine coolant heater to assist starting in freezing temperatures. The power cord is located in the rear cargo compartment on the driver side of the coach. When plugged into the receptacle, the heater is connected to both the shoreline and the auxiliary generator, so a separate extension cord is not needed. The power switch is a standard household light switch located above the OnePlace panel.



Diesel Engine Heater Switch

REMEMBER! Turn the engine heater switch off after starting the engine. The heater will keep operating for as long as it is supplied with electricity. If the switch is left on, the engine heater will come on each time you hook up the shoreline cord or start the generator.



PARKING BRAKES

The parking brakes are applied by pulling outward on the large yellow knob on the dash to the left of the steering column. Push the knob in to release the brakes.

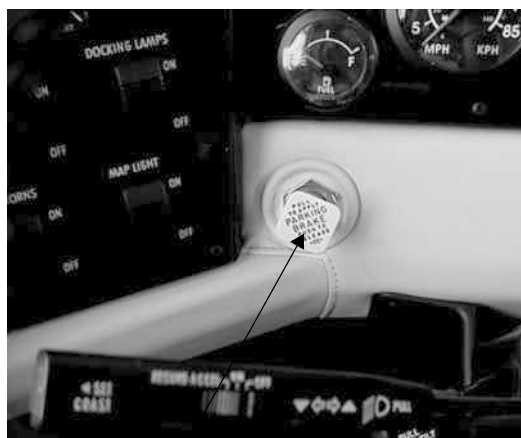

Parking Brake Knob

Use the parking brakes whenever the vehicle is parked. Never try to drive the vehicle with the park brake applied. This can cause excessive wear on the brakes and may damage the transmission.

NOTE: It is normal to hear an occasional burst of air pressure from the rear of the vehicle. This is an automatic moisture purging feature of the air brake system. See the Brakes section of your Spartan chassis manual for instructions on periodic draining of brake air tank.

JACOBS® ENGINE BRAKING SYSTEM

(Jake Brake)

Many large diesel trucks are equipped with compression release engine braking systems also known as “Jake Brakes”.

They are called Jake Brakes because the original maker of this type of braking system was Jacobs Vehicle Systems, the brand which is equipped on the engine of your coach.

The Jacobs Engine Brake is a hydraulically operated device mounted on the top of the diesel engine that changes the timing of the exhaust valves and increases engine vacuum.

The idea behind a Jake Brake is to use engine vacuum to provide braking power. If you’ve ever driven a stick shift car and downshifted to pro-

vide braking, you were using engine vacuum to slow the car down.

The exhaust retarding action of the Jake Brake takes this a step further. It actually turns the power-producing engine into a giant, power absorbing air compressor, which provides effective braking power, especially on long downgrades.



Engine Brake Switch

To Use the Engine Brake: The engine brake activation switch is located on the lower left side of the dash. Press and release the ON side of the switch to activate the engine brake system. The engine brake will operate whenever you let up on the throttle pedal while the switch is ON.

Press and release the OFF side of the switch to deactivate the engine brake system and return to chassis air brakes alone.

WARNING

Do not activate the engine exhaust braking system while on icy or extremely wet roads or in any other situation where abrupt deceleration could cause skidding or loss of vehicle control.



HAZARD WARNING LIGHTS

The hazard warning flasher switch is located on the underside of the steering column near the signal/cruise lever. Pull the switch button outward from the column to activate the flashers. To cancel flashers, push the switch button inward toward the column. See also Section 3 for further operating information.

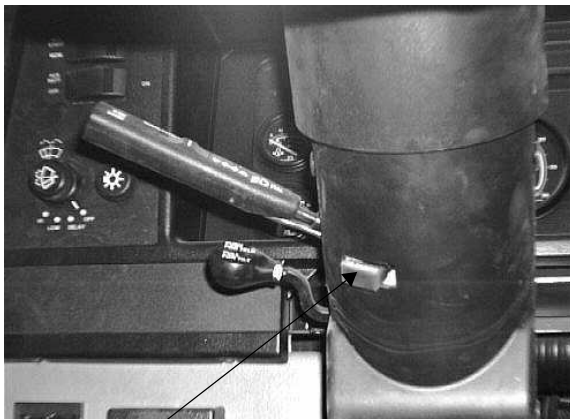

Hazard Light Switch
 Pull On/Push Off

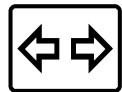

SIGNAL LEVER/ HEADLIGHT HI/LO BEAM

The signal lever controls the turn signals, high/low beam changing.



Turn Signals/Hi-Lo Beams



HEADLIGHT BEAM CHANGE AND TURN SIGNALS

Move multi-function lever upward for right turn signal and downward for left turn signal.

Pull end of handle toward you to switch high beam to low, or low beam to high.

STEERING COLUMN TILT/TELESCOPE

The tilt/telescoping adjustment lever is located on the left side of the steering column.

To Adjust Tilt Wheel: Pull the lever toward you and tilt the steering wheel to the desired angle, then release the lever.



Pull to Tilt
 Push to Telescope

To Adjust Telescoping Column: Push the lever toward the dash. Push or pull the steering wheel to slide the steering column in or out to the desired length. Release the lever to lock the column into position.



WARNING

Do not adjust the steering column or tilt wheel while the vehicle is in motion. This could cause a loss of vehicle control.



(Truckers often use this signal as a greeting or an expression of thanks for assistance in passing, etc.)

SMARTWHEEL™ STEERING WHEEL CONTROL SYSTEM

The Smart Wheel™ Control System offers convenient and safe control of the horn, headlight and marker light flash, cruise control, and wiper functions all from switch panels mounted at your fingertips on the steering wheel.

HORN BAR

- Normally sound chassis horn.
- Also sounds air horns if Air Horn switch on dash is activated.

HEADLIGHT COURTESY FLASH

- Press and release to blink or flash the headlights.
- Night: If the headlights are already turned on, pressing the switch will blink them off briefly.
- Day: If the headlights are off, pressing the switch will flash them on briefly.

(Truckers often use this signal to indicate to a passing rig when it is clear to pull back into the lane ahead of them.)

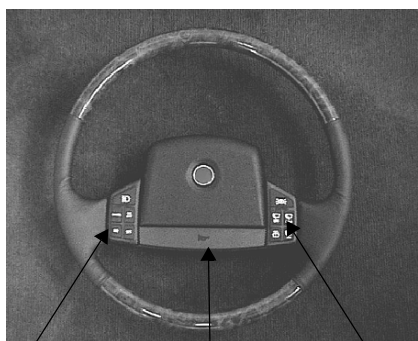

Cruise Control Pad Horn Bar Wiper Control Pad

MARKER LIGHT COURTESY FLASH

- Press and release to blink or flash the marker (clearance) lights.
- Night: If the marker lights are already turned on, pressing the switch will blink them off briefly.
- Day: If the marker lights are off, pressing the switch will flash them on briefly.

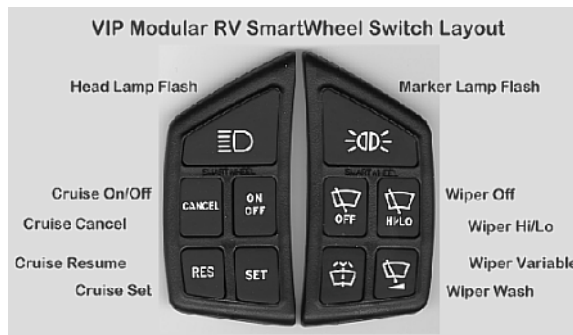

CRUISE CONTROL FUNCTIONS:

ON/OFF (Cruise System On/Off)

- Press to turn cruise control system on or off.
- This will also erase previously set speed.

SET (Set Speed/Coast)

- Press to maintain current desired driving speed. Will not work below 40 mph.
- This button will also perform “Coast” feature. Press and hold until vehicle slows to desired speed and release to establish new ‘set’ speed.

RES (Resume/Accel)

- Press to return to previous ‘set’ speed after braking or reducing speed.



CANCEL

- Press to switch cruise function off without losing current ‘set’ speed.



! WARNING

Do not operate the cruise control on icy or extremely wet roads, winding roads, in heavy traffic, or in any other traffic situation where a constant speed cannot be maintained.

WIPER FUNCTIONS:

There are four wiper control buttons:

- ON/HI/LO
- DELAY
- WASH/WIPE
- OFF

WASH/WIPE

- Press switch to activate Lo wipers and spray washer fluid onto the windshield for as long as you hold the button.
- After you release the button, the wipers will continue for three wipe cycles, then turn off.
- If wipers are already active, pressing the switch will simply spray fluid onto the windshield without affecting wiper setting.



WIPER ON/HI/LO

- Press to turn wipers on at Lo speed
- then press again to switch wiper speed back and forth from Lo to Hi speed.
- Press Off button to switch wipers off.

WIPER DELAY

This switch will set a Lo speed wiper delay time based on the duration between any two presses of the button.

Here's how it works:

- During a light rain or mist, when your windshield needs a clearing wipe, press the button once and the wiper will swipe back and forth once a Lo speed. Let's say 7 seconds later, the windshield needs another wipe - press the button again and the delay time will be set to 7 seconds.
- If the mist gets heavier and you press the button again 3 seconds after the last wipe, the delay time will be reset to 3 seconds.
- The delay time can be set from approximately 1 to 30 seconds.

WIPER OFF

- Press to shut wipers off.
- Wipers will also switch off when the ignition is turned off.

NOTE: Many states now have laws that require headlights to be on during precipitation conditions. To assure compliance with this law, the headlights will come on whenever you press any of the wiper function buttons - Hi/Lo, Wash or Delay. You can manually reset the headlights by the cycling the headlight switch (on the dash) on and off. The headlights will also turn off when the ignition switch is turned off.

IDLE SPEED CONTROL

The cruise control system can also be used to increase or decrease engine idle speed (rpm) while parked if desired. Press the ON/OFF button to activate or deactivate the idle control circuit. Press the Brake Pedal to cancel idle speed functions and return to normal idle.

SET BUTTON INCREASES IDLE RPM FROM NORMAL IDLE SPEED:

- Press and release to increase engine speed from normal idle to about 1000 rpm.



- Press and hold to ‘ramp up’ engine speed, then release at desired rpm. Maximum idle speed is about 1700 rpm.
- Press the On/Off or Cancel buttons or the Brake Pedal to return the engine to normal idle.



RES BUTTON DECREASES HIGH IDLE RPM:

- Press momentarily to ‘bump down’ engine rpm in preset increments until it settles back to 1000 rpm.
- Press and hold to ‘ramp down’ engine speed until it settles back to 1000 rpm.
- Press the On/Off or Cancel buttons or the Brake Pedal to return the engine to normal idle.

Pedal Adjustment

The accelerator and brake pedals may be adjusted forward or rearward for maximum comfort and control using the button on the driver side armrest panel.



ENTRANCE DOOR LOCK AND HANDLE

The entrance door may be opened from outside the vehicle by pulling the door handle outward. To open the door from inside, pull outward on the door handle. When the door is locked, neither the inside nor the outside door handle can be operated. It can be locked and unlocked from the outside of the vehicle by inserting the key into the lock and turning, or by using the keyless remote entry system.

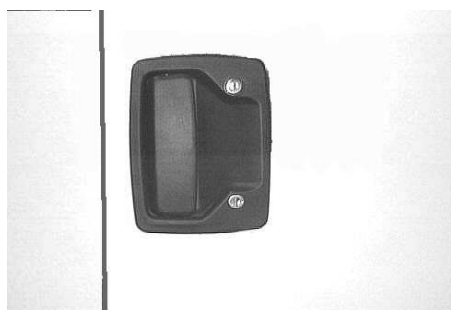

To lock the door from inside, rotate the lock levers as indicated. The deadbolt lock is for added security and should be used as a security night lock.

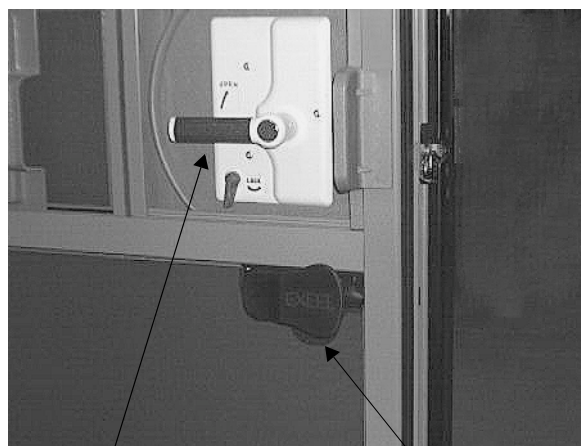

Door Latch Handle

Screen Door Latch

Entrance Door Handle - Inside

Lubricate the locks periodically with graphite to maintain good working condition.

CAUTION

When releasing security night lock, be sure to retract bolt before opening door latch to prevent drag on bolt pin. Instruct all passengers in operation of this door catch system as well as emergency exit window.

 **POWER DOOR LOCK - with Keyless Remote Entry System**

The power door lock controls the side entrance door.



Storage Compartment Door Locks

Entrance Door Locks

Power Lock Switch



Keyless Remote Entry System

The keyless entry is a remote control power door lock system. This feature allows you to unlock or lock your entrance door and cargo doors from outside the coach without using a key.

Lock: When you leave the coach, simply press the “lock” button on the remote transmitter attached to your key ring. The entrance door will lock. Your parking lights will flash once to tell you that the door has locked.



Keyless Remote Unit

Unlock: When you return to the coach, press the “Unlock” button on the transmitter and your parking lights will flash twice to tell you that the door has unlocked. The porch light will also come on for 20 seconds to light your way to the coach.

If You Lose a Remote: Your dealer can order replacement remote keyring transmitter if you should lose one, or if you simply want a spare.

When you get a new remote unit, the receiver/control unit in the coach must be programmed to recognize the signal code of the new remote. For simple programming instructions, refer to remote lock manufacturer’s information in your owner InfoCase. If you do not wish to do this yourself, you can see your dealer to have the receiver/control unit programmed for you.

Replacing Batteries in Remote Units: The battery should last for one year under normal use.



When the transmitting range of the remote unit drops, the battery is probably becoming weak.

1. Remove remote unit from key ring and lay face down.
2. Remove screws from rear corners of case.
3. Open transmitter case. Do not lose key ring swivel. It is not fastened to case.
4. Remove old battery and insert new battery in same direction (+/-) as old battery.
5. Close case and replace case screws.

The compact 12 volt battery used in these units is available at most electronic shops and camera shops.

Recommended 12 volt battery:

- Gold Peak GP27A or GP23A
- Bronica B-1
- Radio Shack #23-144 or #23-279

NOTE: Keys should always be removed when leaving the vehicle. Since doors can be locked without keys, make sure they have been removed from the ignition before locking the driver's compartment.

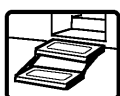

ELECTRIC ENTRANCE STEP

The power switch for the electric entrance step is located to the left of the main entry door as you enter the coach.

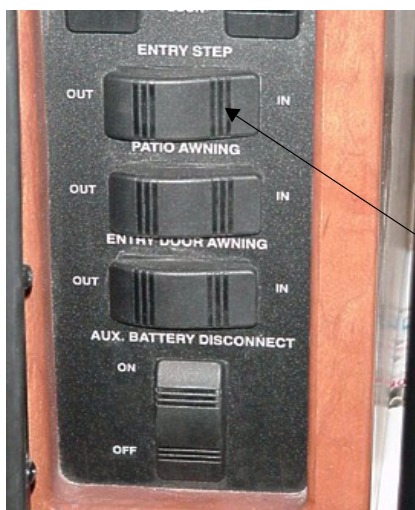

Press to cancel door switch

Automatic Mode (Operates with Door)

With the Power Switch in the On position the step is in Automatic Mode. This means it will extend and retract automatically whenever the door is opened or closed. This is done by means of a magnetic door switch attached to the lower hinged edge of the screen door section of the entrance doors. The steps will extend when the screen door is opened, and retract when the screen door is closed. With the power switch in the Off position the step can be kept in the extended or retracted position as described below.

Stationary Extended Mode

To keep the step in the extended position:

- turn the Power Switch to **On**,
- **open** the screen door to extend the step,
- then turn the Power Switch to **Off**.

The step will now stay extended whether the door is opened or closed. This position is normally used when parked at a campsite or whenever people are going to be entering and exiting the vehicle frequently.

Automatic Retraction Feature

The coach is equipped with a step retraction feature that retracts the step automatically when the Ignition Switch key is turned to either the On or Start position regardless of whether the Step Power Switch is On or Off. This feature is standard and is installed to prevent injury or damage which may be caused by an extended step when the vehicle is moving. An associated feature is the "Last Out Feature". This feature extends the step when the screen door is opened after the ignition switch has been turned to either the On or Start position.



! WARNING

Do not use steps unless it is fully extended.

Do Not Stand on step when vehicles ignition switch is turned to either the “On” or “Start” position. The step will automatically retract, which may cause personal injury. Always remember to retract the step before moving the vehicle.

For additional information on the step, see the step manufacturer’s operators manual included in your Owners *InfoCase*.

STEPWELL COVER

The stepwell cover can be extended to cover the stepwell area and increase usable floor space in the front of the coach while the entrance door is not in use.

Press and release the Step Cover switch on the passenger sidewall armrest. The step will extend or retract fully. It is not necessary to hold the switch down while the cover is extending or retracting.

- Press OUT to extend.
- Press IN to retract.



! CAUTION

Stay clear of entrance step area when stepwell is being extended or retracted. When entering or exiting, loose clothing may catch on components of the mechanism. Personal injury and/or property damage may result.

Rotate the knob pointer back to the CLOSED position to resume power operation.



STORAGE COMPARTMENT DOORS

The storage compartment doors have power locks connected to the keyless entry system. They may be locked and unlocked using the key fob remote unit or the lock switches on the driver armrest or entry switch panel.

2-Stage Door Props

Compartment doors located below the bedroom slideout rooms are equipped with 2-stage door props.

The 1st stage holds the door open at a position parallel to the ground to avoid contact with extended slideout rooms.

If the slideout room is closed and clearance is not an issue, you can lift the door higher and a 2nd stage will kick in that lets the door rise higher for greater access.

Latch Properly

To ensure that compartment doors have latched properly, press the bottom edge of the door with the palms of your hands. This is more important for smaller and lighter compartment doors because when the door is “dropped” closed, the air trapped inside the compartment may create a cushioning effect that could sometimes prevent door latches from engaging properly.



adjustment by repositioning the mirror arm or head. If you cannot move the mirror by hand, see your dealer for adjustments.



POWER ELECTRIC MIRRORS

The electric mirrors are adjusted using a multi-directional switch located on the driver's side armrest.



Power Mirror Controls



Select the mirror to be adjusted by pushing the switch in the middle of the control to the right or left. Then press the arrow buttons as necessary to obtain the best view.

When mirrors are adjusted to preference, place the selector switch back in the middle position to cancel power to the buttons. This prevents accidental misadjustment of mirror settings.

The mirrors also contain heating elements to defog or de-ice the mirror glass during cold weather operation. An ON-OFF switch for the mirror heaters is located near the mirror control.

If you cannot adjust the mirror properly using the control switch, the mirror may need a coarse



SONY COLOR REARVIEW MONITOR SYSTEM



Refer to the Owner's InfoCase for specific instructions provided by Sony.

Powered Sunvisors

The powered sunvisors are controlled by switches on the driver and passenger armrest panels. The driver side contains switches for both sides to allow driver control. The passenger side has a switch only for the passenger side visor.

Press and hold DOWN side of the switch to extend, then release at the desired position. Press and hold UP side of the switch to retract the visor.



Power visor switches on driver armrest panel



Always be careful to position visors so they do not impair the driver's forward vision or side-view mirror vision.

TripTek Coach Computer

The TripTek computer is tied in with many engine and chassis systems to give you instant information on engine and drivetrain performance, service reminders, trip information, and fuel economy. Data is displayed on the rearview monitor screen using the control pad on the lower right dash panel.



GPS Mapping System

The Alpine GPS system can help you confidently navigate your course into the densest concrete forest or out on scattered country backroads with satellite positioning technology.

See the ALPINE Mapping System operation guide in your InfoCase for detailed instructions on using this system



ELECTRONIC COMPASS & OUTSIDE THERMOMETER



COMPASS OPERATION

The compass has two (2) buttons - MODE and °F/°C - which are used to change the unit between the various operating modes.

Ignition On Operation:

1. Unit displays outside temperature and compass heading.



2. Press the °F/°C button to toggle between displaying °C and °F.
3. If the unit has been properly calibrated, the heading will remain 'on' continuously. If the unit does not have a valid calibration, the heading and the word 'CAL' will flash continuously.
4. If the temperature reading is valid, the temperature display will remain 'on' continuously. If the temperature reading is invalid (due to an open or shorted temperature sensor), the temperature reading will flash continuously.
5. Unit goes to SLEEP MODE when ignition is turned off.

Sleep Mode Operation:

1. Unit enters SLEEP MODE when ignition is turned off.
2. The display is blank and the unit is in a LOW POWER MODE.
3. Unit wakes from SLEEP MODE and enters:
 - A. Ignition ON operation when the ignition is turned on, or
 - B. CAMPING MODE when the °F/°C or the MODE button is pressed for three (3) seconds.

Camping Mode Operation:

1. Unit enters CAMPING MODE after the °F/°C button or MODE is pressed for (three) 3 seconds while in SLEEP MODE.
2. Unit displays temperature and heading for ten (10) seconds; the display stays 'on' if you continue to push either button and then returns to SLEEP MODE ten (10) seconds after the last button was pushed.

Nighttime Dimming:

The display brightness is lowered by 50% when the vehicle headlights are turned on.

Calibration:

NOTE: The calibration procedure requires you to drive your coach in a circle during calibration mode, so you will need to be in a large area clear of obstacles, such as a vacant section of a parking lot.

The compass must be calibrated after its initial installation and anytime the compass sensor is replaced or relocated. The calibration values are saved in EPROM memory, so it is not necessary to recalibrate if the battery is disconnected.

Calibration Procedure:

(Best performed in empty parking lot)

1. Press and hold the MODE button until the words 'ZONE' and 'CAL' appear (approximately ten (10) seconds). The unit will display the current zone value.
2. Press the °F/°C button to increment the zone value.
3. Press the MODE button to store the zone value.
4. The unit now displays the word 'CAL'. Press the °F/°C button to enter the calibration mode. The display will begin counting down from 60 seconds and the word 'CAL' will flash. Drive slowly in a circle during the 60 second calibration period. If the calibration procedure fails, the unit will flash the word 'CAL' continuously. If the calibration procedure is successful, the unit will display the word 'CAL' for five (5) seconds and then return to normal ignition 'on' operation.

ICE WARNING

The ICE feature is designed to alert the driver when ice may be present on the road. The feature works as follows: When the temperature transitions from above 40° F to below 37° F, the ICE feature is enabled. The ICE feature loops through the following displays for 1 minute; "ICE" for 2 seconds, "outside temperature" for 2 seconds. After the 1 minute timeout expires, the ICE feature is disabled, and the unit returns to displaying the outside temperature. The ICE feature remains disabled until the temperature climbs above 40° F. The ICE feature only works in ignition on mode. The feature is not present in camping mode. For the ICE feature to be enabled, the outside temperature must be above 40° F. If the temperature is below 40° F when ignition is turned on, it is assumed that the driver is already aware of the cold temperature.



CONTINUOUS SELF CALIBRATION:

The self calibration is done in two phases: the first phase is FastCAL™ and the second phase is SmartCAL™. FastCAL™, as the name implies is an initial fast calibration routine. When the compass is first powered up and there are no calibration settings saved in its memory or after you have completed the procedure to erase the current calibration settings, the letters “CAL” will be flashing on the display. The compass is now in FastCAL™ mode. After you complete your first 90 degree turn the “CAL” letters will turn off and the compass will be accurate to within 1 cardinal point. The compass will remain in FastCAL™ mode until, under normal driving conditions; you have completed two or three circles. By this time the compass sensor will have taken multiple reads in every direction and will have gathered enough information about its environment to be fully calibrated. If the battery power is removed from the compass before it has completed the FastCAL™ routine, it will start FastCAL™ over the next time it is powered up. Turning ignition power on and off will not affect the FastCAL™ routine. After the FastCAL™ routine is completed the compass switches into the SmartCAL™ mode. SmartCAL™ is an ongoing, fine tuning of the calibration settings. In the SmartCAL™ mode, whenever the compass is operating in normal ignition on mode, it will continually take readings from the compass sensor and compare those readings to what it has saved in its calibration settings. The compass will use the new information it gathers to fine tune its calibration settings so it will be as accurate as possible, even when you travel in and out of areas where the earths magnetic fields get stronger or weaker.

Calibration:

NOTE: The calibration procedure requires you to drive your coach in a circle during calibration mode, so you will need to be in a large area clear of obstacles, such as a vacant section of a parking lot.

The compass must be calibrated after its initial installation and anytime the compass sensor is replaced or relocated. The calibration values are saved in EPROM memory, so it is not necessary to recalibrate if the battery is disconnected.

Calibration Procedure:

(Best performed in empty parking lot)

1. With the engine running, press and hold the MODE button until the words ‘ZONE’ and ‘CAL’ appear (approximately ten (10) seconds). The unit will display the current zone value.
2. Press the °F/°C button to increment the zone value.
3. Press the MODE button to store the zone value.
4. The unit now displays the word ‘CAL’. Press the °F/°C button to enter the calibration mode. The display will begin counting down from 60 seconds and the work ‘CAL’ will flash. Drive slowly in a circle during the 60 second calibration period. If the calibration procedure fails, the unit will flash the word ‘CAL’ continuously. If the calibration procedure is successful, the unit will display the work ‘CAL’ for five (5) seconds and then return to normal ignition ‘on’ operation.

ZONE ADJUSTMENT

When you travel outside the zone, the unit is currently set ‘on’, the compass has reduced accuracy. To achieve maximum accuracy, it is recommended to change the zone setting when traveling to a new zone in the U.S. To change the zone setting, follow steps (1.) through (3.) of the CALIBRATION ROUTINE, at which point the unit will display the word ‘CAL’. Press the MODE button again to skip calibrating. It is not necessary to recalibrate the compass when you change zones.



Compass zones for the U.S.



SPECIFICATIONS

Parameter	Min	Avg Typ	Max	Units
Operating Voltage	9	12	18	Volts
Operating Temperature	-40	-	85	°C
Storage Temperature	-55	-	105	°C
Supply Current @12V				
Active Mode		0.3		Amps
Sleep Mode		0.001		Amps
Compass Accuracy	+/-5			Degrees
Compass Resolution			45	Degrees
Temp. Measurement Accuracy	+/-1			°C
Temperature Display	-40		127	°F
	-40		53	°C



SEATS

The driver and co-pilot seats may be independently adjusted to suit individual preference.

The seats may be swiveled to provide easy entrance and exit. The swivel feature also allows the seats on some models to be turned toward the living area for additional seating while the unit is parked.

DRIVER SEAT

Power Seat Controls: The power seat controls are located on the lower aisle side of the driver seat as shown.

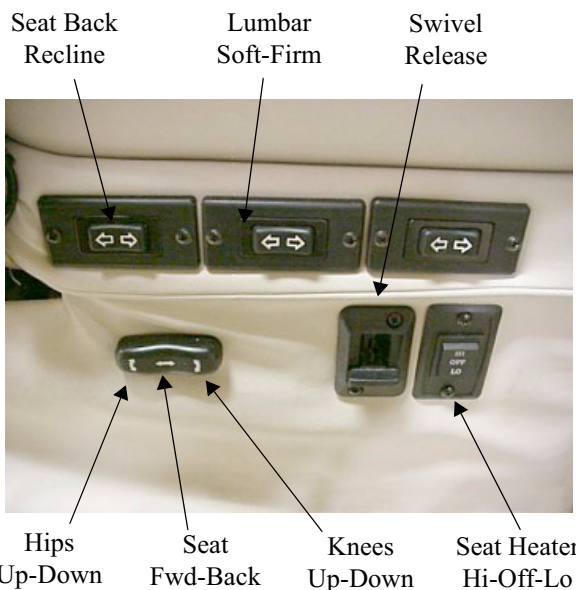

REMOTE CONTROLLED SPOT/FLOOD LIGHT - Optional

If your coach is equipped with the remote controlled spot/flood light option, the light is controlled by a hand-held remote control unit included in your Owner InfoCase. This convenient features allow you to operate the spotlight without having to be in the driver seat. You can operate it from anywhere inside that coach, and even while outside the coach for a limited distance.



On/Off Button Spot/Flood Focus Directional Controls L-R/Up-Down

Swivel: Lift the swivel release lever to swivel seat toward the aisle. The lever is located on the lower aisle-side of the seat by the power seat controls.

Power Recline: The recline button is located on the lower aisle-side of the seat. Push the button rearward, until seat reclines at desired angle and release the button. To return to upright, press the recline button forward and the power seat back will return to the upright position, then release the button. The seatback should only be reclined moderately while driving to maintain effectiveness of seat belts, and to avoid passenger sliding beneath lap belt in event of impact.



! WARNING

Do not adjust driver's seat while vehicle is in motion.

After adjusting seat, always use body pressure to make sure slide and swivel locking mechanism have engaged.

Lumbar Support:

The lumbar support control button is located on the lower door-side of the seat. Press the arrow button forward to increase lumbar support or rearward for less support.

Armrests: The armrests can be swung upward and out of the way for easy access or access to the front seats.



Turn Wheel to Adjust Armrest Height

A thumbwheel is located inside a cutout on the underside of the armrest as shown for adjusting the resting angle of the armrest.

Turn the wheel to adjust the armrest angle up or down for personal comfort while reclined or upright.

PASSENGER "BUDDY" SEAT

The seat control instructions for the passenger seat are the same as the driver seat, except the lo-

cations are opposite or 'mirrored' to keep aisle-side and door-side positions.

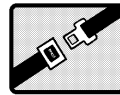
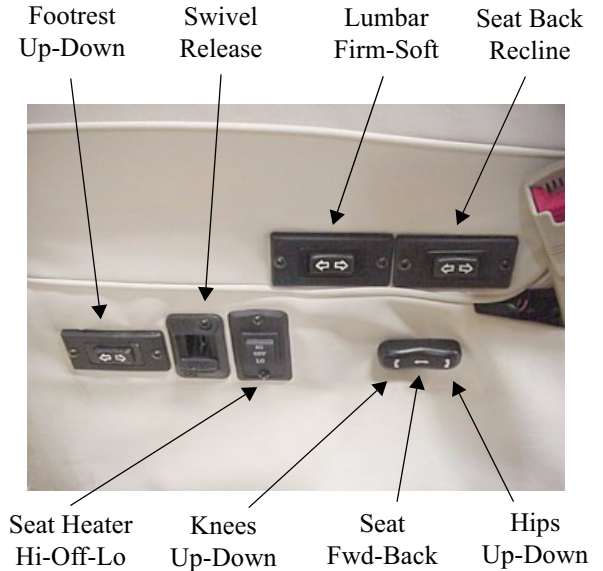

SEAT BELTS

Seats intended for occupancy while the vehicle is in motion are equipped with seat belts for the protection of the driver and passengers. The lap belts must be worn as low as possible and fit snugly across the hip area. Always sit erect and well back into the seat. To gain full protection of the safety belt, never let more than one person use the same safety belt at any one time, and do not let the safety belts become damaged by pinching them in the doors or in the seat mechanism. After any serious accident, any seat belts which were in use at the time should be replaced.

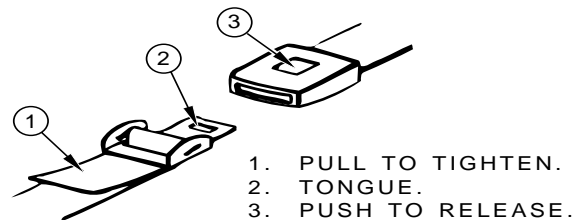

Adjustment: To lengthen belt, turn tongue at a right angle to belt and pull to desired length. To shorten, pull loose end of belt.



To Fasten: Be sure belt is not twisted. Grasp each part of the belt assembly and push tongue into buckle. Adjust to a snug fit by pulling the loose end away from the tongue.

To Release: Press button in center of buckle and slide tongue out of buckle.

WARNING

Snug and low belt positions are essential. This will ensure that the force exerted by the lap belt in a collision is spread over the strong hip area and not across the abdomen, which could result in serious injury.

Only seats equipped with seat belts are to be occupied while vehicle is in motion.



THREE-POINT LAP-SHOULDER BELTS

The driver and co-pilot seat belts in your coach are equipped with automatic locking retractors that let you easily adjust your seat belt to the proper length for passenger safety.

Fastening:

- Grasp the belt just behind the tongue using the hand nearest the door or sidewall. Be sure the belt is not twisted before fastening.
- Pull the belt smoothly across your body, then insert the tongue into the buckle on the aisle side of the seat until it locks with a positive “click”.
- Feed any excess belt length back toward the seat so the belt retractor will lock the belt at the proper length for your body when released.
- The lap belt portion must be worn snug and low across the pelvic area.
- The shoulder strap portion must be worn diagonally across the chest and over the shoulder, but not against the neck.

- Seat belts offer optimum protection only when worn properly on the body and when the seat is in an upright position.

Unfastening:

- Press the release button in the buckle.
- Hold onto the tongue when you release it from the buckle to keep it from retracting too rapidly.

WARNING

Never wear the shoulder belt in any position other than as stated above. Failure to do so could increase the chance or extent of injury in a collision

SEAT BELT CARE AND CLEANING

- Be careful not to damage the belt webbing and hardware. Take care not to pinch them in the seat or doors.
- Inspect the belts and hardware periodically. Check for cuts, frays, and loose parts. Damaged parts should be replaced. Do not remove or modify the belt system.
- Keep belts clean and dry. If the belts need cleaning, use only a mild soap and water solution. Do not use hot water. Do not use abrasive cleaners or bleach. These products may weaken or damage the belts.
- Replace any belt assembly that was used during a severe impact. Replace the complete assembly even if damage is not apparent.



CHILD RESTRAINTS

All 50 of the United States and the District of Columbia now require the use of the child/infant restraint systems for children in vehicles.

A properly installed and secured child restraint system can help reduce the chance or se-



verity of personal injury to a child in an accident or during a sudden maneuver. Children may be injured in an accident if they are not seated in a child restraint which is not properly secured.

A child restraint system is designed to be secured in a vehicle seat by a lap belt or the lap belt portion of a lap-shoulder belt. According to accident statistics, children are also safer when properly restrained in rear seating positions than in front seating positions.

When purchasing a child restraint system:

1. Look for the label certifying that it meets all applicable U.S. Federal Motor Vehicle Safety Standards (FMVSS) or, in Canada, requirements of the Children's Car Seats and Harnesses Regulations (CCSHR).
2. Make sure that it will attach to your vehicle and restrain your child securely and conveniently so that you are able to install it correctly each time it is used.
3. Be certain that it is appropriate for the child's height, weight and development. The instructions and/or the regulation label attached to the restraint typically provides this information.
4. Review the instructions for installation and use of the restraint. Be sure that you understand them fully and can install the restraint properly and safely in your vehicle.



INSTRUMENT PANEL

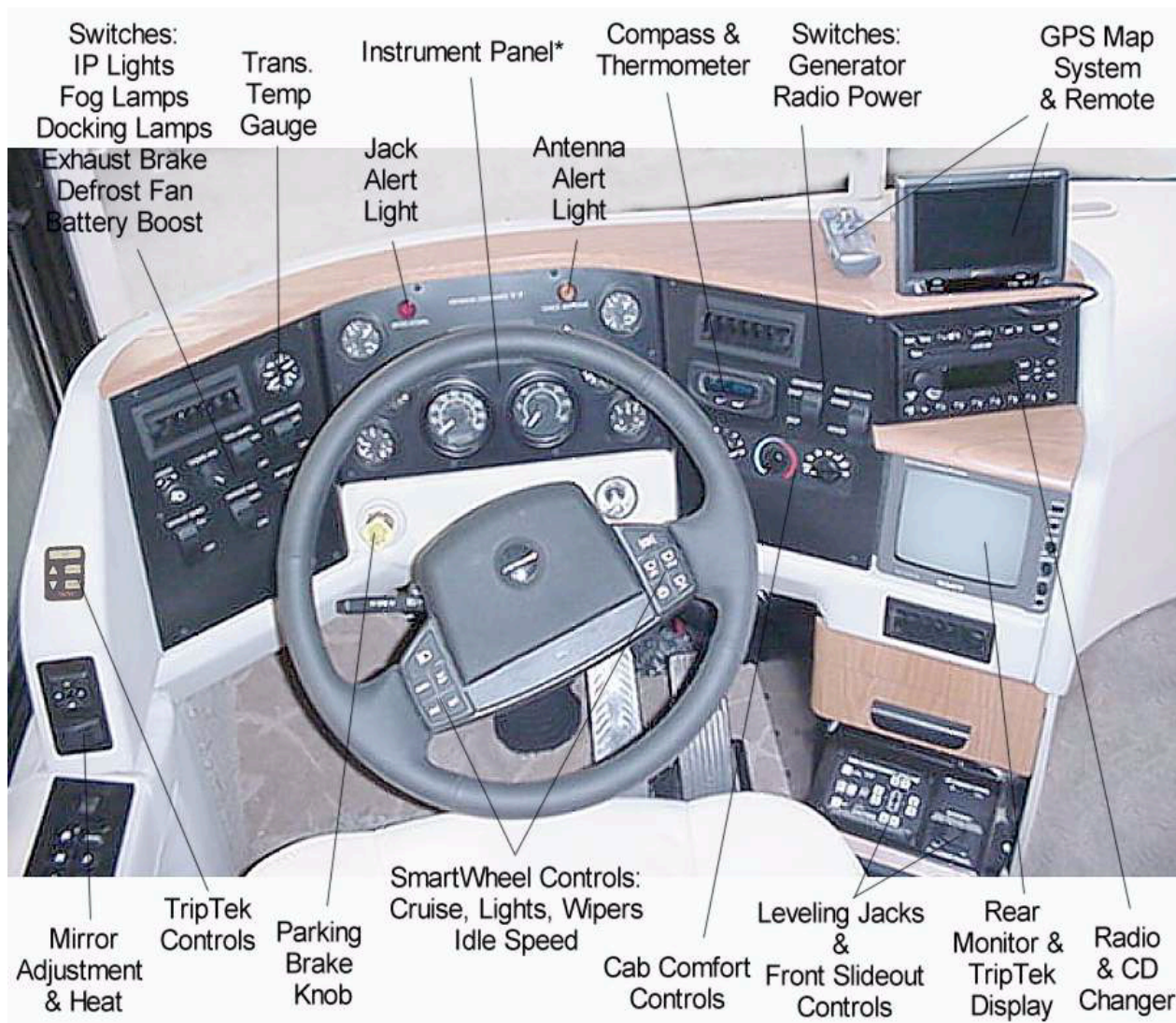

*See your Spartan chassis operator manual for details.

NOTE: Some equipment or controls shown may be optional or unavailable on your mode.



COMFORT CONTROLS

AUTO AIR CONDITIONER/ HEATER

Controls for the air conditioner, heater, defroster and vent are all combined into one control panel. Refer to the following instructions for use of individual controls.

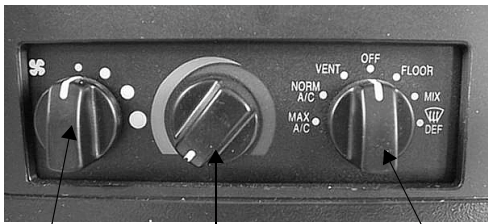

Fan Switch Temp Control Mode Control

Driver Side Controls



Passenger Side Controls

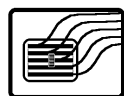

HEATING

- A. For maximum heating
 1. Turn the mode selection knob to HEAT or VENT.
 2. Turn the temperature control knob to WARM (red) zone.
 3. Place the fan switch to high (largest dot).
- B. For reduced heating:
 1. Turn the temperature control knob to a medium position for desired comfort.

2. Adjust the fan speed for desired volume.



DEFROSTING

- A. For maximum defrosting and defogging:
 1. Turn the mode control knob to DEF.
 2. Turn the temperature control knob to WARM (red).
 3. Turn the fan switch to high (largest dot).
 4. Turn on auxiliary (windshield) fans if additional air movement is needed
- B. For reduced defrosting:
 1. Turn the temperature control knob to the left to an intermediate setting.
 2. Adjust the fan speed for desired volume.

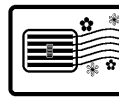

VENTILATION

- A. To vent outside air into the vehicle when neither heating or cooling is required.
 1. Turn the mode selection knob to vent.
 2. Turn the temperature control knob all the way to the left to the COOL (blue) zone.
 3. Adjust the fan speed for desired volume.



AIR CONDITIONING

- A. For maximum cooling.
 1. Turn the mode selection knob to MAX A/C.
 2. Turn the temperature control knob all the way left to the COOL (blue) position.
 3. Turn the fan speed switch in to high (largest dot).

OFF

When no heating, cooling or defrosting are required:

1. Turn the mode selection knob to OFF. This will shut off the fan and prevent outside air from entering the unit.



SECTION 2 DRIVING YOUR MOTOR HOME



NOTE: The automotive air conditioner is not designed to cool the entire interior of the motor home, but is intended to cool the driver's compartment only.

⚙️ **ENERGY TIP:** Turn off any electrical items or accessories (lights, fans, defoggers, etc.) when not being used. This reduces fuel consumption by cutting down electrical load on the automotive alternator. The more electrical items being used, the greater the electrical “pull” on the alternator, which causes the engine to work harder and use more fuel.

ANTENNA CHECK LIGHT

The antenna check light will come on for 20 seconds when the ignition switch is turned on to remind you to be sure the TV antenna and satellite dish are lowered completely into the roof cradle for travel storage.



“Check Antenna”
Light



SOUND SYSTEM

CD6™ Music System - Radio/CD Changer

The CD6™ Music System in your coach can receive AM/FM stereo stations and is also a 6-disc CD changer for hours of your uninterrupted

favorites. Quality high-output speakers are located in several areas of the coach for your listening enjoyment.



Please refer to the Visteon radio manufacturer’s operating guide in your InfoCase for detailed instructions on programming preset station buttons and using this full-featured radio/audio system.

Radio Power Switch

The radio power switch lets you connect the dash radio to the coach batteries with the ignition switch turned off for listening while parked. This prevents accidental draining of the chassis (starting) battery during prolonged operation of the radio.

Deluxe Sound System

Your coach is equipped with a deluxe sound system featuring special high-output cube speakers and subwoofers to enhance your listening enjoyment.

- To enhance radio/CD sound while driving, press the Radio Power Switch (on dash) in the ENGINE position and turn the Speaker Switch (in video center) to RADIO position.
- To enhance radio/CD sound while parked, press the Radio Power Switch (on dash) in HOUSE position and turn the Speaker Switch (in video center) to RADIO.



- To enhance TV sound, press the Radio Power Switch (on dash) in HOUSE position and turn the Speaker Switch to TV position.

BATTERY BOOST SWITCH

This switch can be used to provide emergency starting power from the motor home auxiliary battery if the automotive battery is discharged.



If the engine starting (chassis) battery is dead, press and hold Battery Boost switch while turning the ignition key for an emergency starting boost from the house batteries.

AUXILIARY BATTERY DISCONNECT SWITCH

The Aux. Battery disconnect switch disconnects the auxiliary (coach) batteries from the 12-volt system of your coach to avoid long-term battery drain by electrical items that are hooked directly to the coach batteries.

The Aux. Battery Disconnect switch is located on the entry switch panel. Always leave this switch ON except during storage periods. Some electronic displays and memory functions may need to be reset after power has been reconnected.



Aux. Batt. Switch

See also Battery Storage and Maintenance in Section 6 - Electrical Systems.

CAUTION

NEVER disconnect battery power to the hydronic heater using the Battery Disconnect Switch or circuit breaker while the heater is operating. Doing so may cause serious damage to the heater, which may not be covered under warranty. Always shut down the heater using the remote power switch before using the battery disconnect switch.



CB RADIO WIRING (Optional)

Your coach is pre-wired for CB radio installation. The wires are located beneath the dash to the left of the steering wheel.

Look for a pair of wires, yellow (+) and white (-), with connectors and flag labels, suspended from the wiring harness.

Be sure to read the wire labels before installing a CB radio. The labels contain important information and cautions.



SWR Adjustment

To adjust CB antenna SWR (standing wave ratio), turn the adjusting rings of the antenna to achieve the lowest SWR reading. This procedure will help optimize transmitting and receiving capabilities of the radio system.

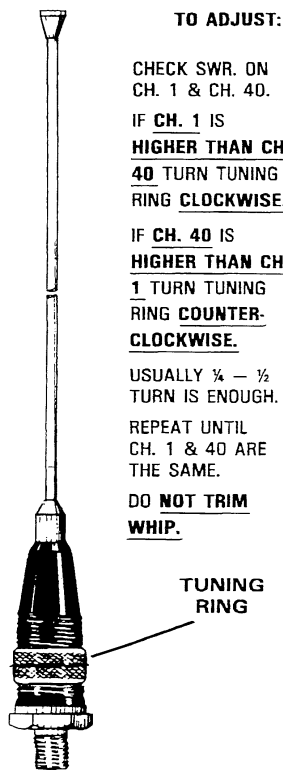
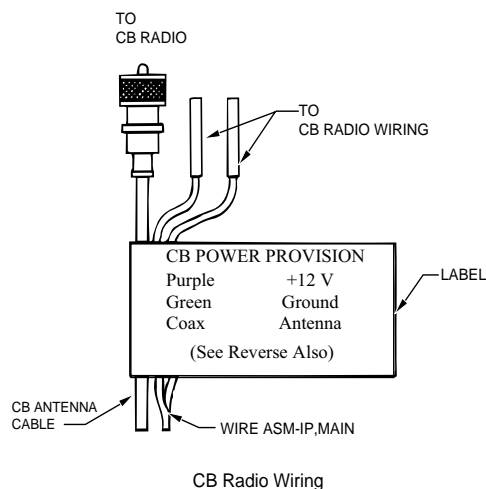

⚠ CAUTION

The CB radio could become damaged if CB antenna SWR is not adjusted before operating CB radio.



AUTOMATIC COACH LEVELING SYSTEM

Your coach may be optionally equipped with a 4-point HWH computerized, automatic, hydraulic leveling system.

This leveling system is designed to diminish problems in selecting a parking site, making “set up” easier and faster for you.

See the HWH Operator Manual in your Owner’s InfoCase for complete operating instructions. It also contains additional precautions, technical information, and instructions for manual operation if automatic functions fail.

The leveling system control panel is located on a swing-out panel at the right side of the dash.



Automatic Leveling System Control Panel

NOTE: When parking at an uneven site, always park the front of the motor home to the downhill side. This allows you to level by raising the front end rather than the rear. Since only the rear wheels are locked



while in PARK, raising either one or both of the rear wheels off the ground could allow the vehicle to roll off the jacks.



⚠ WARNING

Keep all people clear of the coach while the leveling system is operating.

Do not use leveling jacks to support vehicle for service or tire changing.

Further Information

See the HWH Operator Manual supplied in your Owner InfoCase. It contains detailed instructions, precautions and technical information. It also contains troubleshooting instructions for operating system if any functions fail.

NOTE: If one of the leveling jacks should fail to retract, it can be normally retracted by opening a T-handle valve on the reservoir side of the hydraulic pump. The jacks are spring loaded to retract when hydraulic line pressure is relieved. See the HWH Operator's Manual included in your InfoCase for specific instructions on which valve to open and what precautions to follow. The hydraulic pump may be mounted facing a different direction than shown, depending on model. Valves will be in same relative positions.

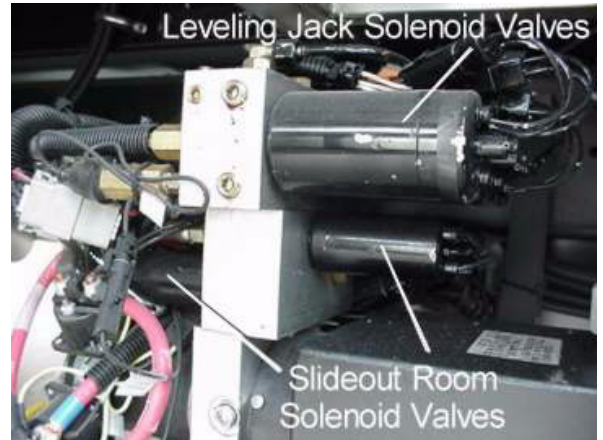

Leveling/Slideout System Hydraulic Pump
(Note valve positions in relation to fluid reservoir)

Turn T-handle out about six turns until fully open.

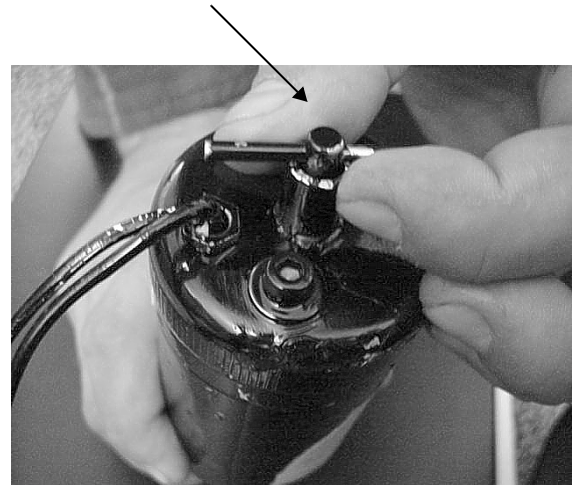

Leveling Jack Solenoid Valve

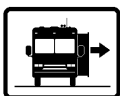

SLIDEOUT ROOM EXTENSION



CAUTION

Release galley slideout room travel latches before attempting to extend galley slideout room. Fasten travel latches before driving vehicle. See the following instructions.

Your coach is equipped with a galley/living room slideout extension to enlarge your living area at the push of a button. The slideout room extends and retracts by hydraulic mechanisms with an electronic control system.

NOTE: Some models are also equipped with a rear bedroom slideout, which is controlled by a separate switch on the bedroom wall.

The lounge slideout switch is located on the lower right dash bezel. (The bedroom slideout switch is located on the bedroom forward wall, just to the left as you enter the room.)

Travel Straps (Front Slideout Room)

The Travel Straps **must be released before attempting to extend the room** or damage to the coach will result.

The travel straps are designed only to help keep the room extension secured against the coach sidewall to maintain an effective weather seal while the vehicle is in motion. They are not designed to withstand the force exerted by the hydraulic extension mechanism and will not prevent extension of the room.

Travel straps are located on the floor near the ends of the slideout room.

To Release:

- Pull the strap buckle outward and up to release tension on strap.
- Pull a short length of the excess strap back through the buckle to provide sufficient slack.

- Unhook the strap end pegs from the mooring brackets on the floor and wall edge. Store straps in location of your choice. (Under the couch is one choice.)



To Fasten Straps:

- Hook the strap end pegs into the mooring brackets.
- Flip buckle downward and press toward strap until it “snaps” snugly into place against the strap.
- If a strap is loose or too tight after closing the buckle, release the buckle and pull the loose end of the strap in or out to adjust tension as needed. Then reclose the buckle.



WARNING

Keep all persons clear of the slideout room and moving parts while extending or retracting. Do not occupy the slideout room while it is being extended or retracted.



To Extend SlideOut Rooms:

CAUTION

Check to be sure the exterior storage compartment doors below the slide-out room extension are closed before extending or retracting the room to avoid possible damage to the finish of the doors.

- Level the coach.
- Set the Parking Brake. An interlock relay system will then provide power to the slide-out control switches.
- Release travel straps (galley).
- Press slide-out switch and hold until room is fully extended, then release switch.
- The front slideout control switch is located on the swing-out panel on the lower right dash.



Front Slideout Switch

- The bedroom slideout switch is located above the OnePlace panel.

Before Retracting Slideout Room

If it has rained recently before you retract the slideout room, we recommend using the hydraulic leveling system to lean the coach and drain off any excess water possibly remaining on the roof before retracting. Lean the coach slightly to the

left (driver's side) as shown by raising both right side jacks to let excess water flow away from the rooftop weatherseal and toward the outside of the slide-out roof.

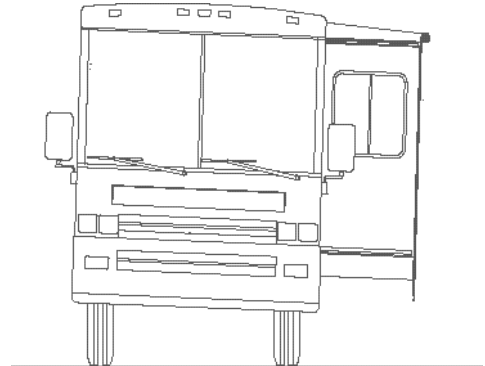

To Retract Slideout Room:

CAUTION

Although there is an awning over the roof of the slideout room, there is a possibility of debris getting onto the roof. Because the slideout roof is drawn into the interior of the coach when retracted, be sure there is no debris, such as excessive dirt, tree seeds, twigs, leaves, etc. on the roof before retracting.

- Remove all items from the coach living room floor. Be sure parking brake is engaged to provide power to the slideout control switch.
- Press the Slideout Power Switch and hold to retract room. Keep holding the switch for about 3 seconds after the room is fully retracted to build up hydraulic line pressure, then release the switch.

General Slideout Care

- Wipe outer seals occasionally with talc or 303 brand protectant for smooth quiet operation.
- Clean the floors inside before retracting the room to avoid vinyl flooring scratches or carpet pile snags.
- Be sure there are no obstruction items at end of bed or behind the driver seat or in compartments. Some items could be crushed or cause



damage to floor covering or cabinets when the room is retracted.

- See your authorized dealer for regular maintenance and service of the mechanism and hydraulic system.
- See the HWH guide in your InfoCase for maintenance information.

If Slideout Room Will Not Operate (Troubleshooting)

- The chassis battery may be low on charge. Press the Aux. Start switch on the dash to the momentary (MOM) position while pressing the slide-out control switch. This momentarily connects the coach batteries to assist in retracting the room.
- One of the fuses may be blown. Fuses are located on the interior firewall beneath the dash, beneath the instrument panel dash pod, and inside the leveling control pad housing. Unfasten the control pad from the driver side armrest panel to inspect the fuse.
- If the batteries and fuses are okay, there may be a failure in the hydraulic system or electrical system. See “Emergency Crank-In Instructions” below for help.

Front Slideout Room Emergency Crank-In Procedure (Use only when slideout room will not retract using control switch)

If a failure occurs in the slideout electrical or hydraulic systems, and the room will not retract using the control switch, you can manually crank the room in using an emergency winch system described below. The winch is stored in a cargo compartment on the passenger side of the coach.

Step 1 - Relieve Hydraulic Line Pressure

- Open the hydraulic pump slideout solenoid valves to release hydraulic line pressure and let fluid bypass into the fluid reservoir. The pump is located behind an access panel in the storage compartment on the driver side of the coach. (It is visible to the rear of this compartment while the slideout room is extended.)



Slideout Pump Access Panel
inside StoreMore compartment



WARNING

Stop engine, place transmission in park position and apply parking brake before lying beneath vehicle for this procedure.

*NOTE: The hydraulic pump is equipped with two types of hydraulic solenoid valves shown. The **leveling jack** solenoids have a **T-handle** on the valve shaft that can be turned by hand. The **slideout room** solenoid has a small 1/4” **nut** at the end of the valve shaft that requires you to use a 1/4” nut driver tool that is provided in your InfoCase.*

See the HWH Operator’s manual included in your InfoCase for specific instructions on which valves to open for front or rear slideout rooms and what additional precautions to follow.

- Open the slideout solenoid valves (with 1/4” nuts on the ends) on the pump to relieve hydraulic line pressure. **DO NOT LOOSEN NUTS MORE THAN 3 FULL TURNS.**

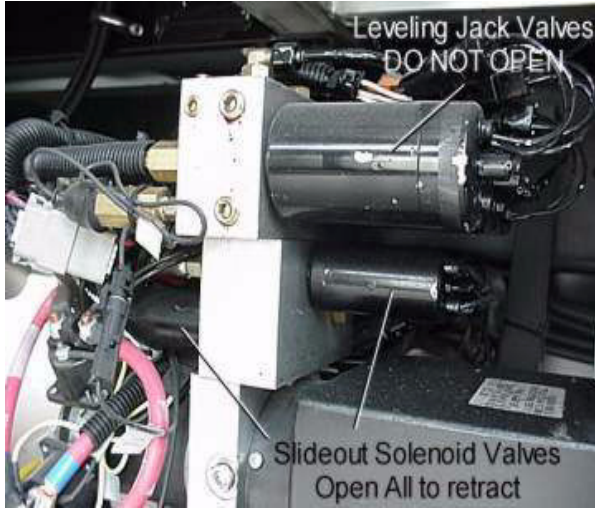

Use provided 1/4" nut driver to turn nut counterclockwise 3 turns only.

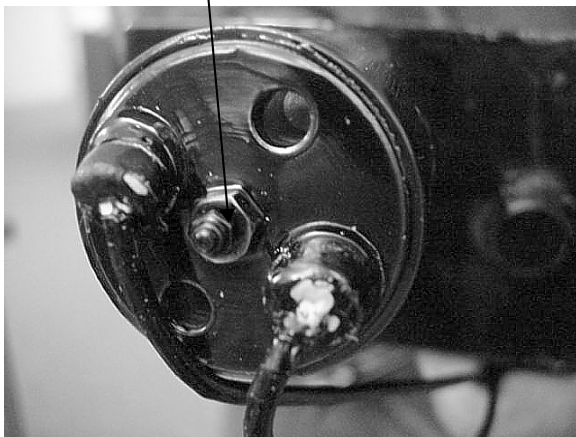

Slideout Room Solenoid Valve

- Do not open any of the four large T-handled valves on the opposite end of the pump. These regulate the coach leveling jacks.

Step 2 - Crank Room Inward

- A wheel (lug) nut wrench is used to crank the room inward. You may use the wrench supplied with the coach (in one of the storage compartments) or any type of lug wrench of the same nut size.
- Crank-in bolts are located on the outboard mounting plates of the slideout room as shown. These plates are located at both ends of the room inside the StoreMore™ compartment doors.

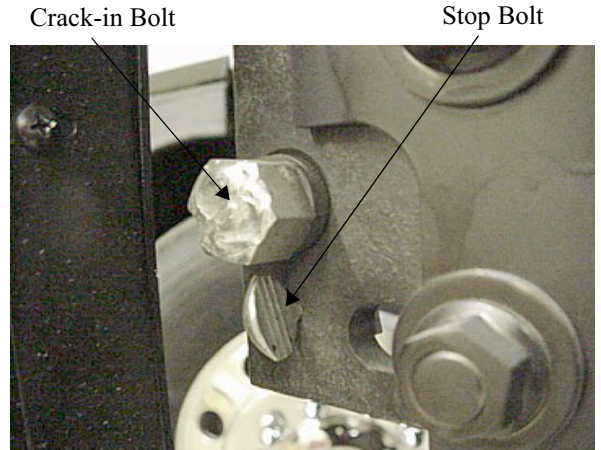

- Loosen the stop bolt beneath the crank-in bolt as shown before trying to turn the bolts.



- After loosening the stop bolts, fit the lug wrench socket onto the bolt head and begin cranking clockwise slowly a few turns, then alternate to the other side for a few turns. This can be sped up by using a helper and an additional lug wrench to crank both sides evenly together.





Crank the tire winch clockwise slowly, until the room is fully retracted. Allow about 10 minutes to crank room in fully.

NOTE: Attempting to crank the room in too quickly will raise pressure in the hydraulic fluid lines and make cranking more difficult.

Step 3 - Secure Travel Straps and Close Hydraulic Line Valves

- Fasten the slideout room Travel Straps.
- Close the hydraulic pump solenoid valves completely.

NOTE: Close the valves snugly, but do not over-tighten. Overtightening may cause internal damage to the valves.

- See your dealer for service of the room extension system before using again.

Bedroom Slideout Emergency ‘Push-In’ Procedure

- Open the “slideout” hydraulic line valves on the pump to relieve hydraulic line pressure. (See Step 1 under “Slide-Out Room Emergency Crank-In” on previous page.)



- **DO NOT OPEN THE LEVELING JACK VALVES.**
- Apply a steady inward pressure of approximately 150 lbs. to the exterior sidewall of the slideout room to push the room in toward the coach until it is snug against the main coach sidewall.

- *NOTE: Use some type of rigid, padded material to protect the sidewall from punctures, dents or other damage to the finish from any device or equipment used to press the sidewall in.*
- Pressure must be applied evenly to avoid binding of the hydraulic mechanism. It may take about 10 minutes to press the room extension inward completely.
- When the room is snug against the coach wall, close the solenoid valves to prevent “creep out” during transit.
- See an authorized Winnebago Industries dealer for service of the slideout control system.

See your Authorized Winnebago Industries Dealer for service of the slideout system before using again.

NOTE: When the system has been corrected, check hydraulic fluid level and refill reservoir as necessary. Press the Retract switch for 15 to 20 seconds before attempting to extend the room. Then run the room out and in several times to purge any air from the hydraulic system. Finally, recheck fluid level and fill as necessary.

Further Information

See the HWH Hydraulic Room Extension operating guide included in your Owner’s Info-Case for further instructions and troubleshooting information.

Power Awnings

The awning control switches are on the entry switch panel.

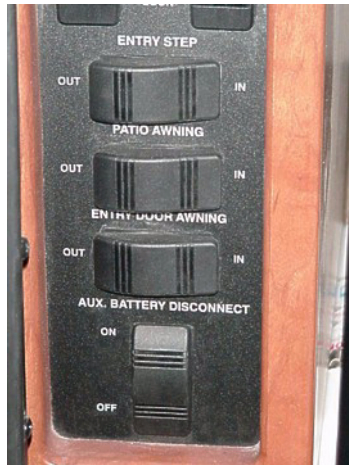

NOTE: The awning retract feature requires the Ignition Switch to be 'ON'.

The auto-retract sensor is in elbow of one of the awning. When the wind becomes strong enough to jiggle the awning and create movement in the arms, the system will sense the motion and retract the awning. This type of sensing system is superior to the windspeed sensing systems that will retract an awning even if the awning is on the leeward side of the coach out of the wind.

The awning control box is located on the forward wall of the compartment to the rear of the entry door. Press the switch to 'manual' position to disable the auto-retract feature, if desired.

NOTE: If the door awning will not retract using the switch it may be manually cranked in using the crank rod stored in one of the right side storage compartments. The crank hooks into a loop at the rearward end of the awning.

Checking Hydraulic Oil Level

See your HWH 625 Series Leveling System Operators Manual for complete maintenance instructions and information.

All maintenance should be done as part of the normal servicing of the coach.

The oil level should be checked when the vehicle is first purchased and then once every two years. More often if there is an oil leak in the system.

Jacks and Slideout Positions:

To get an accurate indication of oil level, all leveling Jacks must be UP and slideout rooms must be positioned as follows for each model*.

Q40KD	RH Front Slideout (Galley) room must be OUT but all other slideout rooms must be IN and all leveling jacks must be UP
Q40ED	LH Rear Slideout (Vanity/Storage) room must be OUT but all other slideout rooms must be IN and all leveling jacks must be UP
Q40AD	RH Slideout (TV/Refrigerator) room must be OUT but all other slideout rooms must be IN and all leveling jacks must be UP

Checking Dipstick:

The oil reservoir is part of the pump/manifold assembly. The oil level is checked and filled through the breather cap.

Clear any dirt and debris away from the breather/filler cap before removing. The oil level should be within one inch of the top of the reservoir, or between the two marks on the breather cap dipstick shown in the following illustration.

**NOTE: If you do not know the model number of your coach, check the Vehicle Certification Label on the wall panel to the left of the drivers seat. See page 0-4 for instructions on reading the model number.*



NOTE: THE BREATHER CAP IS LOCATED ON THE TOP SIDE OF THE POWER UNIT RESERVOIR.

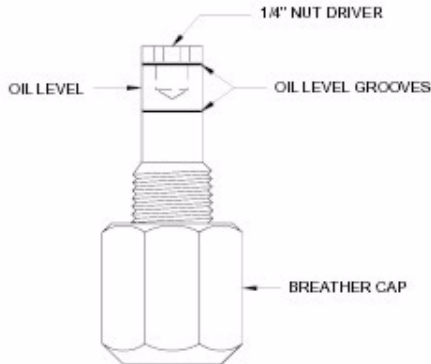

IMPORTANT: PRIOR TO REMOVING THE BREATHER CAP, EITHER TO CHECK THE OIL LEVEL OR TO USE THE 1/4\"/>

NOTE: *Overfilling the tank can cause leakage of oil through the breather cap.*

HYDRAULIC FLUID RECOMMENDATION

HWH Specialty Hydraulic Oil is recommended. In an emergency Dexron automatic transmission fluid can be used.

DO NOT USE brake fluid or hydraulic jack fluid. Use of these can damage seals.

NOTE: *Dexron automatic transmission fluid contains red dye and can cause staining should a leak occur.*

IN CASE OF DRIVING EMERGENCY

HAZARD WARNING FLASHER

The hazard warning flasher provides additional safety when the vehicle must be stopped on the side of the roadway and presents a possible hazard to other motorists. When the flasher is on, it serves as a warning to the other drivers to approach and overtake your vehicle with caution.

WARNING
Operating the hazard warning flasher system while moving on the highway is illegal.

The front and rear turn signals will flash intermittently when the flashers are in operation. When it is necessary to leave the vehicle, the flasher system will continue to operate with the ignition key removed.

See Section 2 for information on operating the hazard warning flashers.

IF YOU GET A FLAT TIRE

In case of sudden tire failure, avoid heavy brake application. Tire manufacturers recommend accelerating briefly to regain steering stability, then gradually decreasing speed. Avoid quick steering movements. Hold steering wheel firmly and move slowly to a safe, off-road place. Park on a level spot, set the parking brake, turn off the ignition, and turn on the hazard warning flasher system.

Emergency Road Service

Because of the size of this vehicle and the possible complications involved in tire changing, this coach is not supplied with a spare tire. If you experience a tire related road emergency, call the number on your Winnebago Industries *Premium*

Roadside Assistance card. A tire center road service unit will be quickly dispatched to your location to service your tire on the spot. A qualified tire center road service unit has the necessary equipment and expertise to handle road tire emergencies quickly and safely.

RECOVERY TOWING

When calling a professional towing service, we recommend that you advise them of your coach length and approximate front axle weight. This will allow the towing operator to determine the proper towing equipment to use. (This information is found on the vehicle certification label located to the left of the steering wheel.)

For safe towing, Spartan recommends a wheel lift towing assembly on chassis like yours with independent front suspension.

Winnebago Industries does not assume responsibility for damage incurred while towing this vehicle.

NOTE: Consult the Spartan chassis operating guide for any additional towing instructions or precautions provided by the chassis manufacturer.

CAUTION
Do not lift on bumper. Damage will result to front end body parts.

WARNING
Stay out from beneath the motor home while it is suspended by the towing assembly unless the vehicle is adequately supported by safety stands. Do not allow passengers to occupy a towed vehicle.

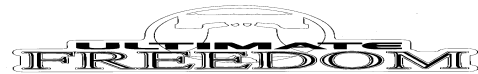

NOTE: Know and obey all state and local towing regulations. Tow at reduced speed.

JUMP STARTING

If your coach will not start from the automotive batteries, try using the aux. start switch to divert power from the coach batteries to the starter. (See Aux. Start Switch on page 2-14.) If you wish to try jump starting the engine using another vehicle or booster system, here are basic guidelines for connecting jumper cables to automotive electrical systems.



WARNING

Automotive batteries produce caustic acid, explosive gases, and electrical current which may cause burns. It is important that the instructions below are followed **exactly**, or personal injury (particularly to eyes) or property damage may result due to battery explosion, battery acid, or electrical (short circuit) burns.

- NEVER smoke near the battery or expose it to open flame or electrical sparks.
- Wear eye protection or shield your eyes while working near battery, in case an explosion does occur. NEVER lean over a battery.
- Do not allow battery fluid to contact eyes, skin, clothing, or painted surfaces. Immediately flush any contacted area with water. If eyes are affected, seek medical help after flushing.
- Remove all metal jewelry to lessen the risk of a short circuit occurring.

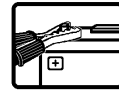

CONNECTING JUMPER CABLES

1. Make sure that the other vehicle has a 12-volt battery and negative ground compatible with your vehicle's electrical system.
2. Position the vehicle with the good battery so that the jumper cables will reach, but **do not allow the vehicles to touch**.
3. Turn off all electrical accessories, motors, and lights except those needed for safety or to light up the work area. Place automatic transmission in N (Neutral) and apply parking brake. Be sure parking brakes are engaged in both vehicles.
4. If the weak battery has filler caps, make sure the electrolyte is at proper level. Add distilled water if fluid is low. If electrolyte is not visible or appears to be frozen - **do not attempt jump starting!** A battery may rupture or explode if the electrolyte is frozen or not filled to the proper level.
5. Connect one end of the positive "+" (red) jumper cable to the positive "+" terminal of the weak battery. Connect the other end to the positive "+" terminal of the charged battery.
6. Connect one end of the negative "-" (black) jumper cable to the negative "-" terminal of the charged battery.
7. Finally, connect the remaining end of the negative "-" (black) cable to a solid, metal grounded location on the engine of the vehicle with the weak battery, at a point at least 18 inches from the battery. Do not connect to any moving parts. **THE MAIN SAFETY PRECAUTION IS TO MAKE THE FINAL GROUND CONNECTION ON THE ENGINE AT A SAFE DISTANCE FROM THE BATTERY. THIS HELPS TO REDUCE THE CHANCE OF EXPLOSION DUE TO SPARKS.**
8. Start the engine of the vehicle with the charged battery, and allow it to run for a few minutes at moderate r.p.m. Then start the engine of the vehicle with the discharged battery.



9. Reverse the above sequence EXACTLY when removing the jumper cables. Start by removing the cable from the ground location on the engine first, then continue in reverse sequence.

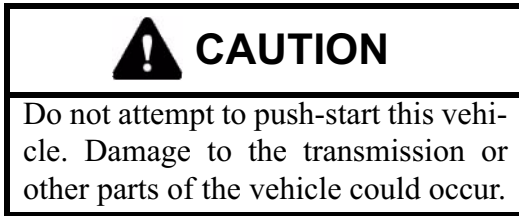

CONNECTING A BATTERY CHARGER

To connect a battery charger, first make sure the engine is switched off. Disconnect the negative (-) lead from the battery. Never disconnect the battery while the engine is running or alternator damage could result.

Connect the positive "+" (red) lead of the charger to the positive "+" terminal on the battery. Next, connect the negative "-" (black) lead of the charger to the negative battery terminal. Finally, plug in or switch on the charger.

To disconnect the charger after charging, unplug the charger from the electrical outlets, remove the charger leads from the vehicle, and reconnect the vehicle leads to the battery.



ENGINE OVERHEAT

If you see or hear steam escaping from the radiator or the engine compartment or have any other reason to suspect an extreme engine overheating condition, pull the vehicle over to the roadside as soon as it is safe to do so, stop the engine and get out of the vehicle.

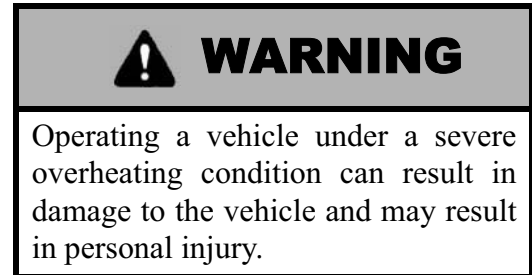

An engine will overheat if the water pump drive belt breaks, if the coolant is low or there is a loss of coolant because of one or more of the following:

- a leak in the cooling system
- a hose failure
- water pump failure

Also, be aware of the following situations, which can cause temporary engine overheating:

- climbing a long hill on a hot day
- idling while stopped in traffic for long periods of time
- towing a trailer or automobile
- stopping after a period of high speed driving

If the TEMP indicator on the instrument panel shows a rise in engine coolant temperature while driving, take the following steps to try to lower the overheating:

- If you are using the automotive air conditioner, turn it off.
- If you are stopped in traffic, shift the transmission into N (Neutral), and engage parking brake.

If the temperature does not drop within a minute or two:

- Pull the vehicle over to the roadside as soon as it is safe to do so.
- Place the transmission in N (Neutral) and press the accelerator to increase engine speed (r.p.m.'s) to twice that of normal idle speed, and hold it there for approximately two or three minutes.
- If engine temperature does not go down, turn the engine off and wait until the engine has cooled before opening the engine compartment



SECTION 3 **IN CASE OF DRIVING EMERGENCY**

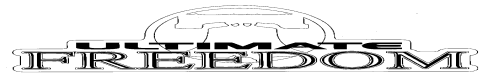

When no trace of escaping steam is heard or seen, open the hood to check for the cause of the overheat. Check hose connections and tighten if necessary. Make sure there are no broken belts, pulleys or hoses before adding any coolant to the coolant reservoir.

For further information about overheating, consult your Spartan chassis operating guide and Cummins Diesel Engine manual.



TRAVELING WITH YOUR MOTORHOME

(See also SAFETY PRECAUTIONS, Section 1 of this manual.)



LOADING THE VEHICLE

NOTE: *Your motor home's load capacity is designated by weight, not by volume, so you cannot necessarily use all available space when loading your motor home.*

When loading the vehicle, distribute the cargo load equally so that you do not exceed either the Front or Rear Gross Axle Weight Rating (GAWR) or the Gross Vehicle Weight Rating (GVWR). The Gross Axle Weight Rating (GAWR) means the weight value specified by the chassis manufacturer as the load carrying capacity of a single axle system as measured at the tire-to-ground interfaces. This is the total weight a given axle is capable of carrying. Each axle has its own rating.

Have your vehicle weighed to determine the proper load distribution for your vehicle. Also distribute cargo side-to-side so the weight on each tire or dual set does not exceed one half of the GAWR for either axle.

For example, if the Front GAWR is 6,000 lbs., there should be no more than 3,000 lbs. on each tire. If the left side weighs 3,100 lbs. and the right side weighs 2,700 lbs., at least 100 lbs. of the load should be shifted from the left side to the right side. The GVWR is listed on the Vehicle Certification Label. (See Introduction Section).

The GCWR (Gross Combination Weight Rating) means the maximum allowable loaded weight of this motor home and any towed trailer or towed vehicle. If trailer towing is not recommended, the GCWR will equal the GVWR.

NOTE: *We recommend that you dump all holding tanks before traveling to avoid carrying unnecessary weight.*



CAUTION

The weight of the loaded vehicle (including options, attachments, passengers, water, fuel, luggage and all other cargo) must not exceed the GVWR or GAWR of either axle.



FRONT AXLE TIRE ALIGNMENT

We recommend that you have the front suspension and steering alignment checked and adjusted after you have fully loaded the vehicle according to your needs. Thereafter, have alignment inspected periodically to maintain vehicle steering performance and prevent uneven tire wear.



WEIGHING YOUR LOADED VEHICLE

To check the weight of your fully loaded coach, locate a commercial weighing scale that is capable of weighing large trucks.

Drive the entire coach onto the scale. This weight should not exceed the Gross Vehicle Weight Rating (GVWR) specified on the Vehicle Certification Label near the driver seat. (See sample in the Introduction Section).

Loading: Load your vehicle completely as if you were going on a long trip, with everything you would carry, including food, clothing, bedding, lawn chairs, etc., a full fuel tank, full LP tank, and maybe a partial tank of fresh water - but empty holding tanks.

Finding a Scale: In urban areas, the most common places to find a public access scale are commercial truck stops. In rural areas, most grain storage elevators have scales available. If

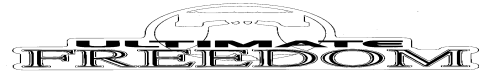

you don't know of a truck scale in your area, look in the Yellow Pages for entries such as Grain Elevators, Scales-Public, Truck Stops, Weigh Stations, etc. If you cannot locate a scale in your area, call your state DOT and ask for recommendations. Most scales charge a nominal fee for weighing a vehicle.

Weighing: There is typically a scale operator to direct you but the basic routine is to take three separate weights - front axle, whole vehicle, and rear axle. You will first drive only your front wheels on to the scale pad, then drive ahead so that the whole vehicle is on the scale, then finally pull off until just the rear wheels are on the pad.



Front GAWR (Front Axle Only)



GVWR (Both Front and Rear Axles)



Rear GAWR (Rear Axle Only)

You will receive a weight 'ticket' that states your current Front Gross Axle Weight, Rear

Gross Axle Weight and Gross Vehicle Weight. You can compare these weights to the weight ratings listed on your Vehicle Certification Label to use as a guideline for future loading limits and weight distribution.

The gross weight of the vehicle should not exceed the Gross Vehicle Weight Rating (GVWR) specified on the Vehicle Certification Label on the rear inner jamb of the drivers door. (see page 0-4). The front and rear axle weight also should not exceed the corresponding Axle Weight Rating specified on the Vehicle Certification Label.

Corner Weighing (Side-to-Side)

Weighing each corner of the coach separately (single LF/RF front wheels or LR/RR rear dual sets) is an accurate method to determine how to distribute your cargo to avoid overloading, especially on tires.

To determine the weight distribution on each tire or dual set, you will need to find a scale capable weighing side-to-side, or all four 'corners' of the vehicle, separately. A truck scale may be used if the ground is level with the scale surface and the scale has clearance to drive one side of the coach onto the scale as shown below.

Drive the coach on the level area next to the scale and straddle the scale so that only one side of the coach will be on the scale pad. Pull only the front wheel onto the pad as shown.



Weighing Left Front 'Corner'

When the front wheel has been weighed, pull the coach straight ahead until only the rear wheel/dual set is on the scale pad as shown.



Weighing Left Rear 'Corner'

After the rear wheel set has been weighed, turn the coach around and repeat this process for the other side.

The load on each wheel or dual-wheel set should not exceed one-half of the corresponding GAWR. For example, if the GAWR for the rear axle is 12,000 lbs., then the load on each rear dual set (left rear duals or right rear duals) should not exceed 6,000 lbs.

Tires should be filled to the recommended air pressure for the highest loaded tire set on that axle. For example, on the rear axle, if the left side weighs more than the right, fill the left tires to the pressure required for that weight, then fill the right tires to the same pressure as the left ones.

NOTE: The Hitch Load from a Towed Vehicle or carrier box must also be counted on the Rear GAWR and subtracted from the rear axle cargo capacity.

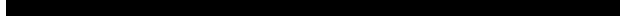

MAXIMUM OCCUPANCY

The following label is placed in a visible location in the driver compartment.

BELTED SEATING POSITIONS MAY EXCEED SLEEPING CAPACITY OF THIS VEHICLE. SEE OWNER MANUAL FOR OCCUPANCY AND WEIGHT RESTRICTIONS.

The number of belted seating positions in your motor home may exceed the number people used to determine maximum coach occupancy, called the Cargo Carrying Capacity (CCC).

To calculate the CCC, Winnebago uses vehicle sleeping capacity, however your coach may be equipped with more belted seating positions than sleeping positions to give passengers a choice of seating arrangements. You may use all of the belted seating positions providing you stay within your vehicle's GVWR listed on the Vehicle Certification Label (see Introduction Section at front of manual). However you use or load your vehicle, it is your responsibility to keep the weight within its stated gross vehicle weight rating.



ROOF LOADING

The roof is capable of carrying some light-weight articles while the vehicle is in motion. A roof-mounted luggage carrier designed for this purpose is available from your dealer. However, roof load while the vehicle is in motion is not to exceed 10 pounds per square foot or a maximum of 100 pounds.

When the vehicle is stationary, a cargo load of 100 pounds plus the weight of a 225 pound person to load the cargo or to conduct inspection and maintenance is permissible.

Weight added to both the roof and the trailer hitch contribute to the gross vehicle weight, which must not exceed the vehicle's GVWR.



CAR OR TRAILER TOWING

Spartan Chassis

Hitch pulling cap.:	10,000 lbs. max
Tongue weight:	500 lbs. max.

The factory installed towing hitch on this coach is rated to pull a 10,000 lb. load (max.), however this does not necessarily mean that you can always tow a 10,000 lb. load. The combined weight of the loaded coach and the towed vehicle could exceed the chassis ratings. Do not exceed either the GVWR, the rear axle GAWR, or the

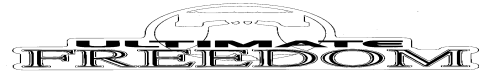

chassis GCWR. See preceding items “Loading the Vehicle” and “Weighing Your Loaded Vehicle” for explanation of these weight ratings. Always be aware of the loaded weight of your coach and the weight of any towed vehicle.

Because of individual vehicle use and loading habits, we recommend weighing the vehicle while fully loaded to avoid exceeding any of the listed Gross Weight Ratings. See “Vehicle Certification Label” in the Introduction Section at the front of this manual for information on gross weight ratings.

Towing will affect vehicle handling, durability and fuel economy. Exceeding any of the listed Gross Weight Ratings will result in unacceptable overall vehicle performance. Maximum safety and satisfaction when towing depends on proper use of correct equipment. Select a drawbar that mates properly with the towing hitch receiver and provides proper alignment to the vehicle tow bar. The tongue of the tow bar must be as close as possible to parallel with the ground when attached to the hitch ball.

Installation of a proper trailer brake system is recommended. Check state regulations on trailer weight and trailer brake requirements to be sure you select the right equipment before towing.

Before descending a steep or long grade when towing a trailer, reduce speed and shift into a lower gear to control vehicle speed. Avoid prolonged or frequent application of brakes which could cause overheating and brake failure.

WARNING

For safety towing and vehicle handling, maintain proper trailer weight distribution.

The total weight of the motor home and the vehicle towed must not exceed the Gross Combined Vehicle Weight rating. Contact the chassis manufacturer to obtain the Gross Combined Vehicle Weight rating for your chassis.

CAUTION

Exceeding any of the recommended gross vehicle weight ratings may result in vehicle damage.

Do not install a frame equalizing type hitch on your vehicle.

See also - Trailer wiring connector in Section 6.



PRE-TRAVEL CHECK LIST

Before starting the engine to leave on a trip, be sure your motor home has been properly prepared and maintained. This will ensure an enjoyable trip and help avoid delays. Use this checklist as a guide.

- Fluid Levels - Check and fill if necessary:
 - engine oil
 - transmission
 - power steering
 - radiator
 - brake
 - battery
 - windshield washer
- Wheel Lug Nuts - Check for tightness
- Tires - Check for proper cold inflation pressures as specified on the Vehicle Certification Label.
- Drive Belts - Check for proper condition and tension (not cracked, frayed, or loose, etc.)
- 110-Volt Generator (Optional) - Check oil level in generator engine.

WARNING

Never check oil level in generator while engine is operating.

- Fire Extinguisher - Make sure it is fully charged and secured in mounting bracket.



- Lights - Make sure all exterior lights operate.
- Sewer and Water Supply Hose - Unhook and store.
- TV Antenna/Satellite Dish - Make certain the antenna and dish are lowered and seated in their support cradles.
- Loose Items Inside the Motor Home - Store or secure items.
- Pilot Lights - Make sure all pilots are off.
- Fuel Tanks - Check level.
- Water Tank - Fill with fresh water.
- Exterior Door and Step - Make sure doors are closed, locked and step retracted.
- Seats - Adjusted for comfortable position and locked in place.
- Mirrors - Adjust for maximum visibility from driver's seat.

TRAVEL TIPS

As you travel around the country in your motor home, you will pick up useful advice from other motor home owners.

A number of suggestions can also be obtained by reading articles and regular columns in outdoor and camping magazines. Some magazines and publishing companies print an annual park and campground directory. These can be found at your local news stand or RV supply dealer. Here are a few travel tips to begin with.

1. Always check for sufficient clearance. Know the height and width of your unit.
 2. Always fill the fresh water tank at an approved potable water filling facility or a known purified drinking water source. Taste the water before filling the water tank in an unfamiliar location. The water in some areas may contain an undesirable taste. Do not use a new hose to fill the water tank. It can leave a distinct rubber or vinyl taste.
 3. Showers can take a lot of water. Conserve water by taking a "Sea Shower". This is done by wetting down, turning off the water, soaping thoroughly and then rinsing.
 4. Dump sewage only at approved dumping stations.
 5. Store liquids in plastic containers with tight fitting caps to prevent spills.
 6. Keep an eye on the water and holding tank levels. It is a good idea to dump the holding tank at least every two days.
 7. When traveling with children, it is helpful to plan their wardrobe for a week. Place each days clothing in a plastic bag and label the bag with the child's name and day of the week for use.
 8. Use sleeping bags whenever possible. They save laundry and take up less storage space than bedding.
 9. Make sure all compartment doors have been closed and the door step has been stowed in the correct position before moving the vehicle.
 10. Before traveling, make sure the refrigerator door has been secured. Use care when opening the refrigerator door after the vehicle has been stopped. Any articles that have shifted may fall out when the door is opened.
 11. During peak tourist season and holidays, it is best to phone ahead and make reservations at the park where you plan to stop.
 12. Some states or cities will not permit vehicles with LP gas containers to pass through highway tunnels. If your route includes a tunnel, check with the highway patrol or department of highways to avoid inconvenience.
 13. Do not leave food or odor-causing material in your vehicle for extensive periods of time. Always allow damp clothing, swimwear, hunting gear, etc., to dry before stowing.
 14. Become familiar with the fire extinguisher and make sure it is always fully charged. Remove and replace it and read instructions so you know the correct operating procedure before an emergency happens.
 15. Make a list of all groceries, fresh meats, vegetables, newspapers, etc., that you may need and try to pick them up during your last fuel stop of the day. This will prevent leaving a good parking spot once you have arrived at your destination.
 16. When you sit over the front wheels while driving, as in a motor home, you have a tendency to crowd the middle of the road. Check the side view mirror frequently to observe how close you are driving to the center line.
-

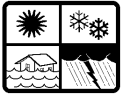

**SEVERE
WEATHER
INFORMATION**

One of the more serious conditions affecting the motor home traveler and camper is that of the weather. Whether you travel the high mountain terrain, the lower deserts and flatland or the plains of the midwest, the weather is always with you and subject to change, sometimes with little or no warning. However, adequate warnings are normally broadcast over local radio and TV stations.

Motor home travelers and campers often seek secluded areas for weekend recreation or extended summer vacations. Many recreational areas are vulnerable to severe weather situations, especially flash flooding conditions. A few simple precautions may help lessen the hazards of flash flooding or reduce your immediate involvement.

NOTE: We recommend that all motor home occupants become familiar with these safety precautions, and be alert to change in weather.

- Be alert, because thunderstorms can form at any time, in any month of the year. Thunderstorms can produce large amounts of rain over a small area in a short time, which may result in a flash flood. Listen frequently to weather reports on the radio for weather and flood conditions.
- When camping near a stream, leave plenty of sloping bank between you and the stream.
- Avoid deep canyons and dry washes during stormy or threatening weather. Be aware of alternate exits.
- If heavy rain occurs, move to high ground immediately (at least 30-40 feet above the canyon floor or bottom of dry wash).
- During a flash flood, if you cannot move your vehicle, abandon it. Do not attempt to return to your vehicle before the water has receded.

- Do not attempt to wade to your vehicle if the water is above your knees - fast moving water exerts an enormous amount of pressure, making it impossible to remain standing or walking.
- Do not try to drive through flooded areas.
- Follow instructions of local authorities. Leave immediately when advised to do so. Many lives have been lost because people did not heed warnings.
- Have on hand survival supplies for several days, including food, water, first aid equipment and necessary medications. In desert areas during hot weather allow 3-4 gallons of drinking water per person, per day.
- Before you leave home, inform someone of your destination and when you expect to return. Authorities at your destination should be notified immediately if you do not arrive on time.

REMEMBER THESE TERMS:

WATCH: Severe weather may develop in the specified area. Be alert and prepare for possibility of an emergency.

WARNING: Severe weather is occurring or is imminent in certain areas. Move to a safe location immediately.

We highly recommend that you obtain a weather-band radio that lets you hear up-to-date weather reports from local offices of the National Weather Service (NWS). Recorded messages that last from three to five minutes are replayed continuously around the clock with updates about every three or four hours. When severe weather threatens, these messages are updated more frequently. If necessary, the weather service will interrupt with storm watches and warnings and live reports when the situation demands.





NIGHTTIME DRIVING

- Make sure all running lights and signal lights are clean and in working order. Have your headlights periodically checked and adjusted.
- Use care when passing other vehicles. Your motor home is a longer vehicle than a car, and you may have a more difficult time knowing when to pull back into your lane. If possible, have another person in the coach help you watch while maneuvering your motor home in traffic.



MOUNTAIN DRIVING

Special techniques must be used when driving in mountainous or hilly country.

CLIMBING A HILL

The transmission will automatically downshift as needed to climb most hills. If the hill is long or very steep, however, you may need to manually shift to a lower gear to keep the transmission from repeatedly upshifting and downshifting. Select the lowest adequate gear range for the duration of the incline. See the Allison transmission manual in your Owners InfoCase for specific instructions.



CAUTION

Observe the engine temperature gauge more frequently than normal. If overheating occurs, pull off to the side of the road and allow the engine to thoroughly cool before refilling the radiator and restarting the engine.

DESCENDING A HILL

When going down a long grade, be sure the Jacobs Engine Brake is engaged, rather than keeping your foot on the brake pedal. Holding your foot on the brake pedal for an extended period may cause brakes to overheat, causing you to

lose control of the vehicle. See your chassis operating guide for more information. See also Jacobs Braking System on page 2-4 or the Jacobs user guide for engine braking information.



CAUTION

Observe the engine temperature gauge more frequently than normal. If overheating occurs, pull off to the side of the road and allow the engine to cool thoroughly before restarting the engine.

CAMPSITE SELECTION

Try to pick as level a spot as possible on which to park your motor home. Whether you nose into a parking site or back into it depends on personal preference and the location of the site's utility hook-ups. Remember that the utility connections on your motor home are on the left (driver) side of the vehicle.



LEVELING

(See "Coach Leveling Systems" in Section 2).

Leveling the motor home is very important, not only for your comfort but for appliances and plumbing as well. Some refrigerators are extremely sensitive to being off level. The ammonia vapor cooling system used in most RV refrigerators can "lock-up" and damage the refrigerator if it is not level. This is both inconvenient and costly. Also, water and holding tank level indicators may give false readings because water level is greater at one side of the tank than the other.

The refrigerator is installed level at the factory. So, if the refrigerator is level, the motor home is level. A small bubble-level sight is included in the refrigerator to help you determine refrigerator leveling.



NOTE: We do not recommend lifting any of the wheels off the ground for leveling. This could allow the coach to roll off the jacks, possibly resulting in damage to the vehicle.

water vapor out of the coach. Avoid making steam from boiling water excessively or letting hot water run. Avoid bringing extra moisture into the coach by way of soaked clothing or snow on shoes. Do not hang-dry wet overcoats or clothing inside the coach.

Hydraulic Leveling System - Optional

See *Coach Leveling Systems* in Section 2 for operating information.



EFFECTS OF PROLONGED OCCUPANCY

Your motor home was designed primarily for recreational use and short term occupancy. If you expect to occupy your coach for an extended period, be prepared to deal with condensation and humid conditions that may be encountered.

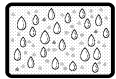

HUMIDITY AND CONDENSATION

Moisture condensing on the inside of windows is a visible indication that there is too much humidity inside the coach. Excessive moisture can cause water stains or mildew which can damage interior items such as upholstery and cabinets. When you recognize the signs of excessive moisture and condensation in your coach, you should take immediate action to minimize their affects. You can help reduce excessive moisture inside the motor home by taking the following steps:

Ventilate with outside air: Partially open one or more windows and a roof vent to circulate outside air through the coach. In cold weather, this ventilation may increase operation of the furnace, but will greatly reduce condensation inside the coach.

Minimize moisture released inside the coach: Run the range hood fan while cooking, and open a bath vent while bathing or showering to carry



SECTION 5 LP GAS SYSTEM



(See also Safety Precautions, Section 1 of this manual.)



LP GAS SUPPLY

The LP gas system supplies fuel for the range, water heater, furnace and refrigerator (while in gas mode). When used and handled properly, this system is safe and economical and provides modern living conveniences wherever you travel.



SAFE USE OF THE LP GAS SYSTEM

The LP system is designed and built with strict adherence to both federal and recreational vehicle industry requirements for mobile LP gas equipment.

For your safety, there are many safety devices and backup systems installed, such as tank fill overflow valves, an interior LP gas detector/ alarm, and an interior carbon monoxide (CO) detector/alarm.

LP gas also contains an odor additive that you can smell if LP is present in the air.

Listed below are a few precautions to observe that will help you to use the LP gas system safely.

- Exercise caution at all times. Be familiar with the distinctive odor of LP gas. If a leak is suspected, turn off the supply valve immediately. Have the LP gas system checked by your dealer or a qualified LP gas service center.
- Do not tamper with the LP gas piping system, pressure regulator or gas appliances. Service and maintenance of LP gas system components should be performed only by your dealer or a qualified LP gas service center.
- Never attempt to connect natural gas to the LP gas system.
- Have the entire LP gas system inspected for possible leaks and missing or damaged parts

at each tank filling. Also inspect before and after each trip, and any time trouble is suspected.

- Turn the LP supply valve off when not using the LP gas system.
- Never use a wrench to tighten the tank supply valve. It is designed to close leak-tight by hand. If a wrench is required to completely close the valve, it is defective and must be replaced.
- Never allow the tank to be filled above the 80 percent level indicated by the flow of liquid gas out of the overflow valve or by the automatic stop-fill device.
- Be sure appliance and outside vents are open and free from obstruction when using the LP gas system.
- Never attach a lock or any device requiring a key to the LP tank compartment door. According to standards set for recreation vehicles, the LP supply valve must be readily accessible in an emergency.
- Exercise caution when drilling holes or attaching objects to the walls. Gas lines and electrical wiring could be seriously damaged and present an extreme safety hazard.

HOW LP GAS WORKS

LP (Liquefied Petroleum) gas is a true gas compressed into liquid form for easy transportation and storage. LP gas is available in two types - propane and butane. It is also called tank gas, bottle gas, or simply LP.

LP is used by appliances in vapor form only, but is stored in the tank as a liquid under very high pressure. As the liquid gas is released, it reverts back to a vapor and expands to many times its compressed volume.



SELECTING LP FUEL TYPES

We recommend using straight propane in your LP tank. Propane gas is commonly available at all LP gas outlets in the U.S. and Canada (According to the National LP Gas Association, LP gas outlets in the United States do not offer any other type of liquefied petroleum gas than propane to the general public.) Check local phone directory yellow pages for locations of local LP gas refilling stations or bulk dealerships.

NOTE: If you travel outside the U.S. with your motor home, you may find butane or propane/butane mixtures available in addition to propane. Because gas-burning RV appliances are designed to run on propane only, we recommend that you request straight propane only. Butane burns about 30 percent hotter than propane and can overheat some appliances, particularly refrigerators, and cause permanent damage. Other appliances designed to operate on propane can become sooted and lose efficiency by using butane fuel.

LP GAS OUTPUT

Each gallon of liquid LP gas contains approximately 92,000 BTU's of heat energy; or about 36.2 cubic feet of dry gas for cooking, heating, water heating and refrigeration.

LP gas tank capacities are often listed in pounds rather than gallons. A gallon of LP weighs 4.24 pounds. LP tanks can only be filled to 80% of their total capacity, so your 130-pound tank would actually hold 104 pounds, or about 24.5 gallons.

To find out how long a gallon of LP gas will last, you should determine the total hourly BTU **input** on all your LP gas appliances in use. Let's say your appliances have a 10,000 BTU **input** per hour of operation. A gallon of LP gas would last 9.2 hours of continuous operation (92,000 BTU's ÷ by 10,000 BTU's = 9.2). To estimate how long a gallon of LP gas lasts, try to determine what your total daily BTU input is, then divide into 92,000 to arrive at an approximate daily LP gas consumption.

LP TANK SYSTEM

The storage reservoir for the LP gas system is a horizontally mounted tank which is permanently attached to the vehicle frame. The tank is accessible only from the outside of the vehicle. The tank supply valve is located near the top center of the tank, next to the regulator. Before opening the supply valve, check to be sure all controls for gas appliances are in the "Off" or "Pilot Off" position. If this step is not performed, LP gas could accumulate inside the motor home creating a fire or explosion hazard.

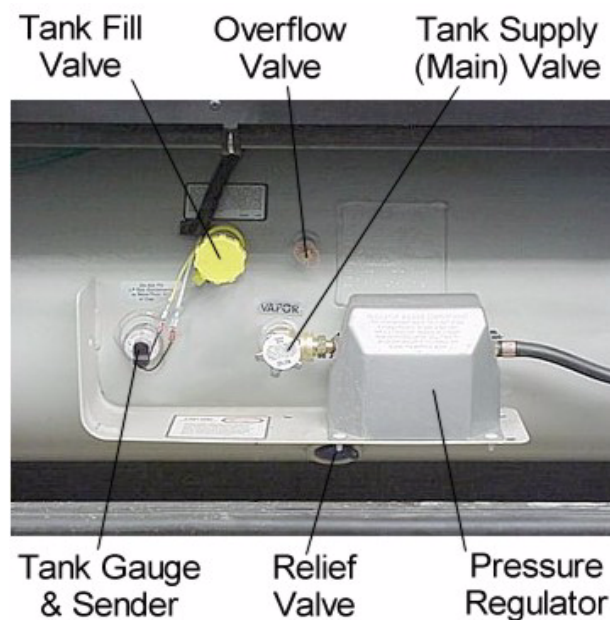

REFILLING LP TANK

There are many LP gas refueling stations located throughout the country. These stations are listed in the telephone directory Yellow Pages under "Gas - Liquefied Petroleum - Bottled and Bulk."

Since the LP tank is permanently mounted to the frame, the motor home must be driven to an LP supplier for filling. Do not attempt to remove the LP tank from the vehicle. The tank is equipped with a fill adapter with both internal and external threads which allows easy filling with any LP filling equipment. The tank is full when liquid LP gas appears at the overflow valve.



NOTE: The LP tank is equipped with an automatic 80% stop-fill device.



LP Gas Tank Capacity:
.....*31 gal. (39 gal. w.c.)

* LP Gas tank capacity shown is the usable “full” LP gas capacity, which is 80% of the tank manufacturer’s listed water capacity (w.c. shown in parenthesis). An LP tank must have at least 20% of tank volume free to allow for expansion and proper vaporization of the liquid fuel. The tank is also equipped with mandatory safety shut-off equipment that prevents filling above this level.

 **WARNING**

Make sure the filling attendant uses the 80% overflow valve when filling the tank. A tank should never be filled above 80% level to allow for vaporization and liquid expansion.

Do not place LP gas containers inside the vehicle. LP gas containers are equipped with safety devices which relieve excessive pressure by discharging gas to the atmosphere.

Do not place LP gas containers, gasoline, or other flammable liquids inside the vehicle. Fire or explosion may result.

AIR IN THE LP GAS TANK

If your LP gas appliances do not stay lit or require frequent adjustment, even though you know the LP tank contains sufficient fuel, the problem may be air in the LP gas tank. Air in the tank mixes with the LP gas vapors causing them to burn poorly. This condition could linger for weeks if the air is not purged from the tank. Most LP gas dealers have equipment for purging air from LP gas tanks and will purge before refilling the tank.

TRAVEL WITH LP GAS

It is illegal for vehicles equipped with LP tanks to travel on certain roadways or through certain tunnels in the U.S. To avoid inconvenience, check state regulations concerning flammable gas transportation.

 **WARNING**

Do not alter or remove LP tank gauge at any time.

 **WARNING**

DO NOT FILL CONTAINER TO MORE THAN 80 PERCENT OF CAPACITY. Make sure the motor home is level when filling. It is possible to accidentally overfill the tank if the vehicle is unlevel, with the fill valve on the uphill side. Overfilling the LP gas tank can result in uncontrolled gas flow, which can cause fire or explosion. A properly filled container will contain approximately 80 percent of its volume as liquid LP gas.

All pilot lights must be extinguished and supply valve closed before refilling LP gas tanks or vehicle fuel tanks.

Do not smoke or expose an open flame while near an LP refueling area. LP gas is heavier-than-air and extremely flammable.

Never use an open flame to test for LP gas leaks.

Replace all protective covers and caps on LP system before filling.

Never fill the LP tank with engine or generator running.



REGULATOR

The pressure regulator is protected from the elements by a plastic cover which should be left in place at all times. Only your dealer or a qualified LP gas service should remove the regulator cover for adjustments.

 **WARNING**

Inspect the pressure regulator vent hole periodically for blockage. If any obstruction is apparent, have the regulator serviced by your dealer or a qualified LP gas service center.

LP gas regulators are installed with the diaphragm vent facing downward. Make sure that the regulator vent always faces downward to minimize vent obstruction which could result in excessive pressure, causing a fire or explosion.

Regulator freeze-ups are caused by the presence of moisture in fuel. This moisture will pass through the cylinder valve and into the regulator where it can freeze. Fuel producers, tank and bottle manufacturers and LP gas dealers take every precaution to reduce moisture, but sometimes only a fraction of an ounce entering the tank can cause problems. To help avoid the possibility of freeze-up, always keep tank control valve closed when not in use, even when tank is empty, to prevent moisture from collecting on the inside.

If regulator freeze-up should occur, you may attempt to thaw the regulator using a light bulb. **DO NOT USE AN OPEN FLAME OR HEAT LAMP.**

If moisture begins to cause problems, have your LP gas dealer inject a small amount of dry methyl alcohol in your tank (approximately one ounce to 20 pounds or one pint to 100 gallons) to help guard against regulator freeze-ups.

In very cold weather when a large volume of gas is being used for heating, it is possible to experience a loss of gas pressure. At first, this problem may appear to be caused by a regulator

freeze-up, but is actually caused by failure of the liquid gas to vaporize as fast as it is needed. As the temperature becomes colder, it is increasingly harder for the liquid LP gas to vaporize. At the same time, the demand for LP to produce heat increases to the point where the system cannot maintain production.

The only solution to this problem is to reduce the consumption of gas where possible. Adjusting the temperature on the gas/electric refrigerator may be a first step. Using less hot water will help as well.



LP GAS LEAKS

The following label has been placed in the vehicle near the range area. If you smell gas within the vehicle, quickly and carefully perform the procedures listed.

 **DANGER**

IF YOU SMELL GAS

1. EXTINGUISH ANY OPEN FLAME, PILOT LIGHTS AND ALL SMOKING MATERIALS.
2. DO NOT TOUCH ELECTRICAL SWITCHES.
3. SHUT OFF THE GAS SUPPLY AT THE TANK VALVE(S) OR GAS SUPPLY CONNECTIONS.
4. OPEN DOORS AND OTHER VENTILATING OPENINGS.
5. LEAVE THE AREA UNTIL ODOR CLEARS.
6. HAVE THE GAS SYSTEM CHECKED AND LEAKAGE SOURCE CORRECTED BEFORE USING AGAIN.

FAILURE TO COMPLY COULD RESULT IN EXPLOSION RESULTING IN DEATH OR SERIOUS INJURY.

 **DANGER**

Never use an open flame to test for gas leaks. When testing for gas lines leaks with a soapy water solution, **DO NOT** use a detergent containing ammonia or chlorine. These substances may generate a chemical reaction causing corrosion to gas lines, resulting in dangerous leak conditions.

LP GAS ALARM - See page 1-2.



WINTER USE OF LP GAS

Due to vaporization characteristics of LP gas, it is important that the winter camper knows how to most efficiently use the LP system. The vaporization rate of LP gas decreases in a direct relationship to a decrease in temperature. Propane will convert to a usable gas at temperatures down to -44°F. For this reason, propane is a popular heating fuel in cold climates.

The greater the amount of liquid gas in the tank (up to 80% level) the greater the amount of LP gas vapor generated. The following is an example of the number of BTU's available from an 84-pound tank at 0° F at three levels. As you can see, the number of BTU's decreases as the tank is emptied. Nearly twice as many BTU's are available from a full tank than one that is one-fourth full.

BTU's Available at 0° F.

<u>Tank Level</u>	<u>BTU's</u>
80%	64,000
50%	50,400
20%	33,000

The following LP Gas Vaporization and Temperature Relationship chart typifies the LP gas loss with a decrease in temperature. The percentage figures are the increase or decrease of vapor that would be available at 0°F. These figures apply to any size LP gas tanks.

<u>Temperature</u>	<u>Percentage of BTU's Available at 0° F.</u>
20° F.	200%
10° F.	150%
0° F.	100%
-5° F.	75%
-10° F.	50%
-15° F.	25%
-20° F.	12 1/2%
-44° F.	Propane will not vaporize

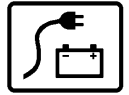

(See also Safety Precautions, Section 1 of this manual.)

Your coach is equipped with an electrical system consisting of two separate voltages; a 12-volt DC system and a 110-volt AC system. The 12-volt system consists of two internal power sources, while the 110-volt system is operated from an outside power source, or from the optional 110-volt generator or 110-volt inverter system.

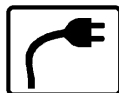

110-VOLT AC SYSTEM

The 110-volt system operates from an outside 110-volt utility service such as those at campgrounds, or from the 110-volt generator or 110-volt inverter system. When the power cord is connected to an outside power source, or when the generator is in operation, the power converter automatically changes a portion of the 110-volt current to 12-volt DC current. All equipment in the motor home that is normally powered by the auxiliary battery is then powered through the converter.

In addition, the following equipment is entirely dependent on 110-volt current: central air conditioner, refrigerator (when placed in 110-volt mode), microwave oven, ice maker, vacuum cleaner and other 110-volt electrical equipment used at convenience outlets.



EXTERNAL POWER CORD (Shoreline)

The external utility power cord (commonly referred to as a “shoreline”) is stored in a compartment on the left (driver’s) side of the coach.



The power cord reel has a two-way switch to extend and retract the cord. Press and hold the switch in the direction desired.

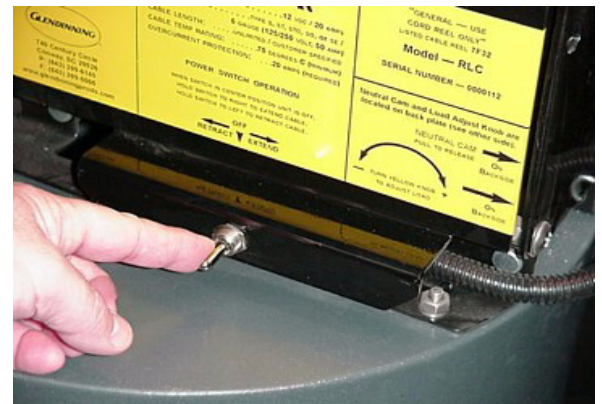

WARNING

Do not connect the external power cord to any receptacle **until** you have contacted the owner and/or attendant of the premises to verify proper polarity and grounding.

It is the responsibility of the owner of the electrical receptacle to ensure that the receptacle is properly wired and grounded.

Reverse polarity and improper grounding of the vehicle can cause personal injury or death.



SECTION 6 ELECTRICAL SYSTEMS



The power cord is designed to ground the electrical system through the receptacle. It is also designed to carry the amperage output of most campground outlets. If the electrical receptacle to be used is designed to mate with the prongs of the power cord plug, the electrical connection can be expected to carry rated load.

The 50-amp shoreline gives your coach extra current handling capacity.

Plug the shore end of the cord (black plug end) into a suitable 50-amp power receptacle to provide external power to the coach and converter/charger system.

NOTE: Some parks do not have 50-amp service available, so you will need to connect to a standard 30-amp service pole using an adaptor.

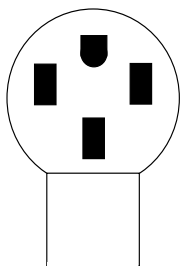

50 Amp.
Power Receptacle

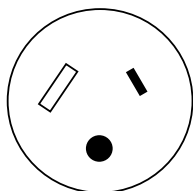

30 Amp Receptacle

A flip down hatch in the compartment floor lets you route the shoreline cord through a passage in the bottom of the compartment so you can shut the compartment door while the shoreline is connected.



1. Flip the hatch downward.



2. Swivel the cover section aside to reveal cord notch.



3. Route the cord through the notch and flip the hatch back up into place and close the compartment door.



⚠ WARNING

Do not plug the power cord into an outlet which is not grounded, or adapt the plug to connect to a receptacle for which it is not designed.

Be sure that all four prongs of the supply cord are properly plugged into the receptacle.

Do not connect the power cord to an extension cord.

Park Fuses or Breakers

Most campgrounds are equipped with a fuse or circuit breaker at the receptacle. This protects the park's wiring, as well as the power cord on your vehicle, from electrical damage. If electrical power fails, contact the park attendants and have them check the fuse or breaker for your supply receptacle.

After disconnecting the power cord, neatly replace it in the storage compartment.

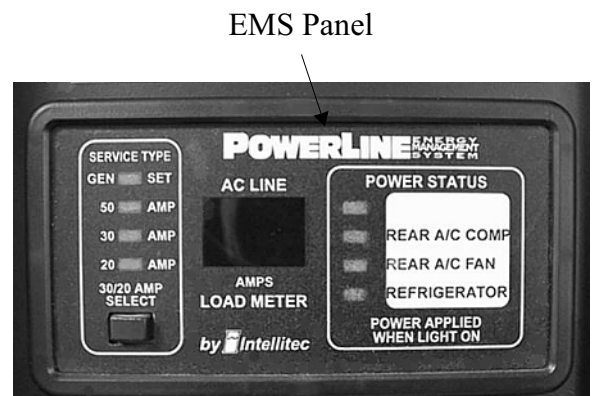

POWERLINE ENERGY MANAGEMENT SYSTEM (EMS)

The energy management system (EMS) monitors the electrical usage of the appliances and equipment in the coach and distributes the electrical loads to avoid nuisance tripping of the shoreline circuit breaker. This system works together with the energy efficient central air conditioner to allow you to run both compressor units at the same time on a 30-amp shoreline connection. The EMS panel is located on the OnePlace systems monitor panel.

Please read your PowerLine Energy Management System Owners Guide for important information on running both air conditioner compressor units at the same time. This guide will also explain how this system operates under several conditions, whether 20-amp, 30-amp or 50-amp connections.

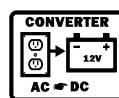

POWER CONVERTER SYSTEM

The power converter changes 110-volt AC current from the auxiliary generator or the shore-



line into 12-volt DC current for use by 12-volt equipment in the motor home.

Certain circuits, however, remain unchanged for use by items which require 110-volt current, such as the air conditioner(s), the refrigerator in AC mode, the microwave oven, etc.

Current drawn from the coach batteries passes through the power center unchanged, although it is routed through a series of protective circuit breakers.

INVERTER/CHARGER AND CIRCUIT BREAKER LOCATIONS

- 2000W Inverter/Charger Unit:**
The inverter/charger is located on the upper rear wall of the battery compartment. The inverter/charger has a power/reset switch and two circuit breakers to protect the inverter and the AC input source from overloads. See the Heart Interface operation information for complete explanation and instructions on this system.



- Inverter Control Panel:** The Heart Interface inverter/charger also has a remote monitor/control panel that can be programmed for several charging configurations. See the Xantrex/Heart Interface remote panel instructions in your Owners InfoCase for complete information and specific configuration directions.



Inverter Charger Control Panel

- 12-Volt House Circuit Breakers:** The 12-volt house breaker panel contains pop-out breakers; push in to reset. The breakers are clearly labeled for the circuits which they protect.

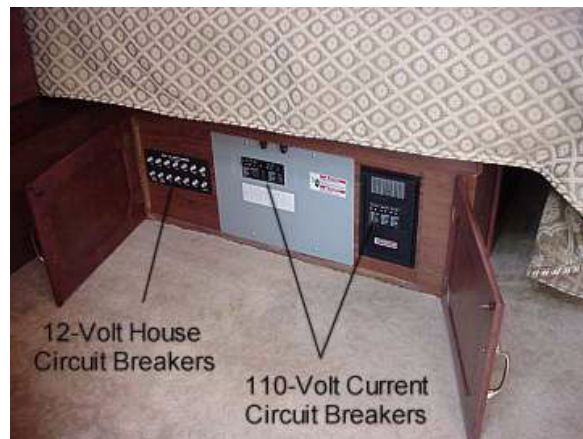

Electrical Load Center
Model 40E or 40K

**Typical view of breaker panel. Actual breaker labels may vary according to appliance and equipment options. Fuses and breakers are labeled on panel.*



CAUTION

Do not store items too closely around the inverter unit in the storage compartment. The inverter generates heat while operating and needs unrestricted airflow for proper cooling.

110-VOLT CIRCUIT BREAKERS

The 110-volt circuit breaker panel protects all 110-volt components in the motor home from either an overload on the circuit or a short in the wiring or component itself. When an overload or short develops, the breaker will open preventing any further flow of electricity and, therefore, damage to the system.

Shut off the equipment (example: air conditioner) and allow a brief cooling period. Then reset the breaker by moving the switch to “Off” and back to “On”. If the breaker continually trips and no equipment is running, have the system checked for a short in the wiring or the appliances.

Model 40E or 40K: The 110-volt circuit breaker panel is located behind a cabinet door in the bed base.

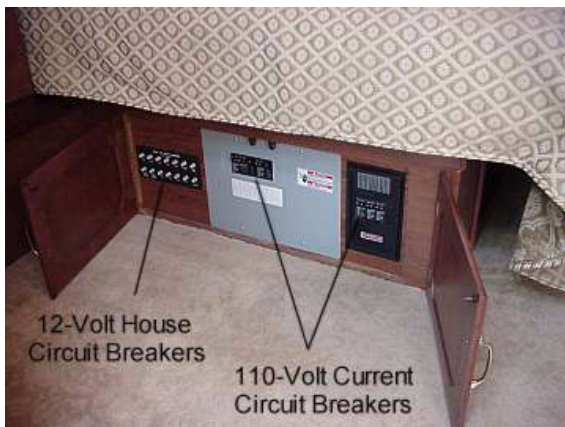

CHARGING SECTION

The house batteries are automatically charged while 110-volt external power is connected. The charger will automatically “sense” the condition of the RV battery. If it is below “full charge”, the Charging Section will start charging the battery.

If the house batteries have been extremely discharged, they will accept charge at a relatively high amperage rate. If they are only slightly discharged, they will charge at a lower amperage rate. The rate of charge will decrease as the batteries reach “full charge”, then will remain

“trickle” charging at a very low amperage rate. If your storage battery does not charge as described above, it is possible the battery is defective.

NOTE: We do not recommend leaving the shore-line plugged in continuously during storage periods because the batteries can lose electrolytic fluids and become damaged from continuous charging without periodic use. We recommend following regular battery inspection and maintenance, especially in cold weather. See “Battery Storage & Maintenance” on page 6-11 this section.

THERMAL OVERLOAD PROTECTOR

A thermal overload protector will shut down the converter if it becomes overheated. This can result from operating above its maximum limit for an extended period of time or by obstruction of ventilation to unit.

NOTE: 12-volt lights and motors will automatically draw from battery power in this event.

The thermal breaker will reset itself after a cool-down period, and the lights and motors will resume operating from the converter. If the overload trips again shortly after reset, take immediate steps to correct the cause of overheating. A portion of house 12-volt load (lights or motors or both) should be turned off to reduce total load. Also, inspect the inverter unit to make sure ventilation is not obstructed.

CAUTION

Do not store items too closely around the inverter unit in the storage compartment. The inverter generates heat while operating and needs unrestricted airflow for proper cooling.



110-VOLT RECEPTACLES (OUTLETS)

A number of standard AC electrical outlets are provided throughout the coach for connecting small appliances such as televisions, radios, toasters, etc. An outdoor outlet is also located on the outside of the coach near the entrance door.

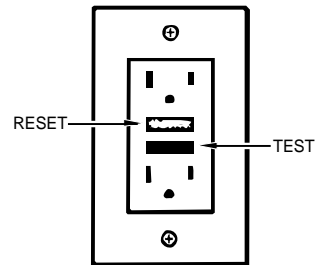

GROUND FAULT CIRCUIT INTERRUPTER

Exterior, bath and galley outlets are connected to a GFCI (Ground Fault Circuit Interrupter), which is an extremely sensitive circuit breaker that will help to protect against severe electrical shock if a ground fault develops. If such a condition occurs, the GFCI will break the circuit by turning off the power to the protected outlets. If this happens, unplug all the appliances on that circuit and press the reset button on the GFCI equipped outlet.

If the GFCI keeps tripping, have the electrical system checked and repaired if necessary before using again.

The GFCI outlets are located in the bath and galley areas of the vehicle.



Ground Fault Circuit Interrupter (GFCI)



WARNING

The GFCI will not completely eliminate electrical shock. Small children and persons with heart conditions or other disabilities which make them especially sensitive to electrical shock may still be injured by a 110-volt receptacles even though protected by a Ground Fault interrupter.

NOTE: In compliance with CSA electrical codes, the appliance outlet in Canadian equipped coaches is not connected to a GFCI protected circuit.

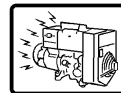

AUXILIARY 110-VOLT GENERATOR

Your coach is equipped with a diesel powered generator. Consult the generator owners manual in your Owners InfoCase for specific instructions on starting and stopping, troubleshooting and maintaining your generator.

NOTE: The diesel generator draws its fuel from the main chassis fuel tank.

After extensive generator use, you may notice decreased levels in the affected fuel tank.



WARNING

Careless handling of the generator and electrical components can be fatal.

Never touch electrical leads or appliances when your hands are wet, or when standing in water or on wet ground.

Do not attempt to repair the generator yourself. Service should be performed by an authorized service center.

Automatic Power Transfer Switch

Your coach electrical system is equipped with an automatic generator power transfer switch. The transfer switch is normally in an “off” mode when no AC current is required.

When the generator is started, the transfer unit will switch the power feed to the generator after 20 seconds. The twenty-second delay is to allow the generator to start easily without an electrical load.

Generator Power Switches: For your convenience we have mounted generator power switches in three locations throughout the coach; in addition to the switch on the generator itself:

- Instrument Panel
- Systems Monitor Panel
- Bedroom (underside of cabinet above bed)

Starting The Diesel Generator

1. Press and *hold* the generator switch ON.
2. If the engine is cold, the starter will not engage until after the glow plugs have pre-heated the engine for a few seconds for easier starting.
3. If the engine is already warm, the starter will immediately engage to start the engine.
4. Hold the starter switch on for several seconds to allow the generator to reach full operating voltage, then release.



Generator Switch and Hourmeter

5. Allow the generator to stabilize running before turning on appliances.
6. Apply electrical loads. Refer to **SPECIFICATIONS** section of generator manual for generator set output and performance ratings. Then refer to the following chart to aid in determining appliance usage during generator operation.

CAUTION

Continuous generator overloading can cause high operating temperatures that can damage the generator windings. Keep the electrical loads within the generator wattage rating.



Approximate Power Requirements of Common Appliances	
Appliance or Tool	Approximate Power Consumption (Watts/Amps)
Vacuum cleaner	200-500W/1.7-4.3A
Coffee Maker	550-700W/4.8-6.1A
Hair dryer	800-1500W/7.0-13.0A
Electric clothes iron	500-1200W/4.3-10.4A
Electric blanket	50-200W/0.4-1.7A
Television	80-100W/0.7A
Electric drill	250-750W/2.2-6.5A
Air conditioner	1400-2000W/13-19A
Microwave Oven	700-1500W/6.0-13.0A

Stopping The Generator

1. Shut off electrical equipment to remove load. Allow generator to run for 3 to 5 minutes to cool down.
2. Press the generator switch into the OFF position and hold until the generator comes to a complete halt.

Generator Hourmeter

This meter is located on the monitor panel. It registers the total number of hours that the generator has been operated. Refer to the hourmeter to determine when periodic maintenance is due and to record services which have been performed.

NOTE: It is normal for the hourmeter to make a periodic “ticking” sound while the generator is running.

OPERATION WARNINGS AND CAUTIONS

WARNING

The exhaust of all internal combustion engines contains carbon monoxide (CO). This poisonous gas is colorless, odorless, tasteless, and lighter than air. The exhaust systems of both your motor home engine and your generator engine have been installed with your safety in mind. However, certain precautions must be taken when using them to protect yourself from conditions beyond the control of the manufacturer.

1. **Do not** simultaneously operate the generator engine and a ventilator which could draw exhaust gases into the vehicle.
2. **Do not** open windows or ventilators on the end or side of the vehicle where exhaust pipe of the generator is located.
3. **Park the vehicle** so that the wind will carry the exhaust away from the vehicle. Also, note the position of other vehicles to be sure their exhaust will not enter your vehicle.
4. **Do not** operate the generator engine when parked if vegetation, snow, buildings, vehicles, or any other object can deflect the exhaust under or into the vehicle.

Check auxiliary generator oil level frequently during periods of use. Refer to the generator manufacturer’s information in your Owners InfoCase for specific recommendations.

WARNING

Never check generator oil level while generator engine is running.

GENERATOR SLIDE OUT SERVICE TRAY: The generator service tray can be extended and retracted by a power slideout mechanism.



To extend generator frame for service:

1. Pull the travel-locking pin from the slide rail. It is located on the driver side of the generator and can be seen by looking down just inside of the “hood” panel opening as indicated by the arrow in the photo below. The pin is tethered to the rail assembly by a small cable.

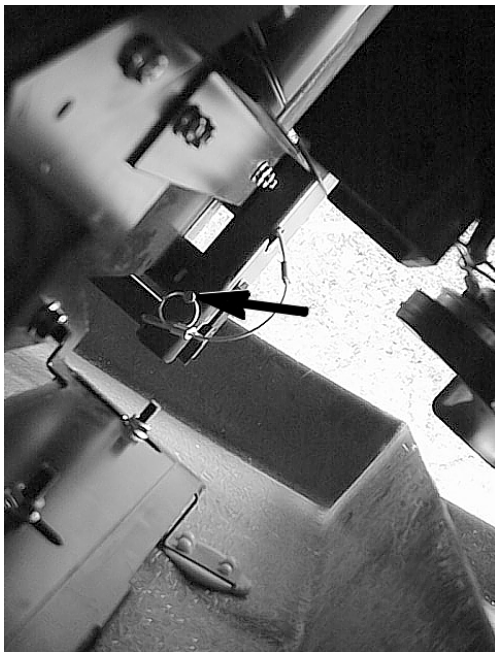

Travel Pin - see arrow
Viewed looking downward at left side of generator through front “hood” panel opening.

2. Push the power slide switch downward and hold until generator frame is fully extended. Lift the switch upward and hold to retract the generator.

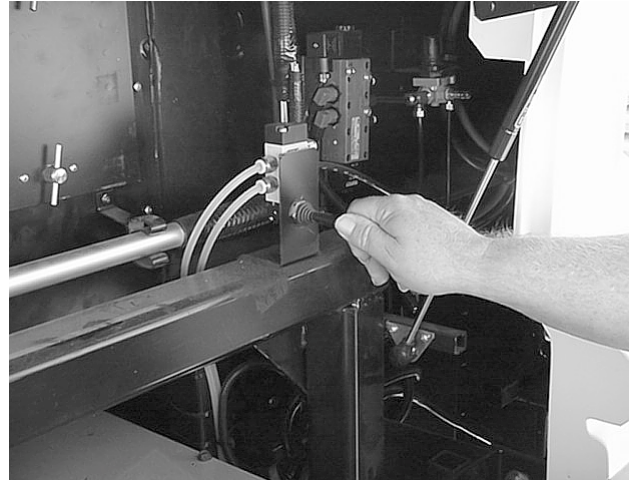

Press switch down to extend; up to retract.

3. After retracting the generator, be sure to reinsert the travel pin into the slide rail frame. You may need to move the generator and grille panel in or out slightly by hand to align the holes properly to insert the pin.

 CAUTION
<p>Make sure travel pin is in place to secure generator before driving after generator service or maintenance. Failure to do so may allow the generator to extend unexpectedly during sudden brake application or other rapid deceleration.</p>

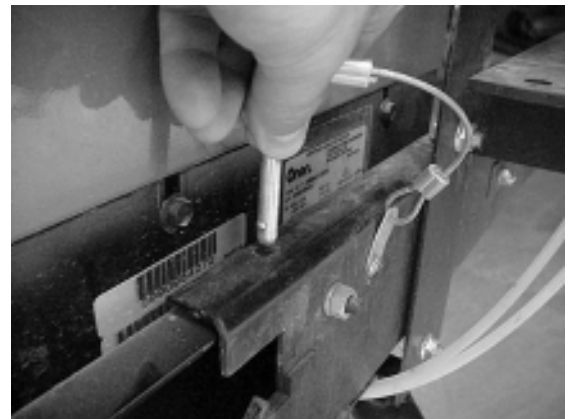

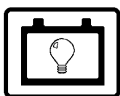

12-VOLT DC SYSTEM

The DC voltage system consists of the automotive batteries and the 12-volt coach auxiliary batteries.

12-VOLT HOUSE CIRCUIT BREAKERS

All 12-volt circuits and equipment in the coach area of the motor home are protected by a circuit breaker panel. When a circuit is overloaded or a short develops in any part of the system, a breaker will shut down that circuit. If this happens, turn off all affected lights or appliances and reset the breaker.

A label on the panel states the amperage rating and circuit protected for each breaker.

The House 12-Volt Breaker Panel is located behind a cabinet door in the bed base or laundry center, depending on model.

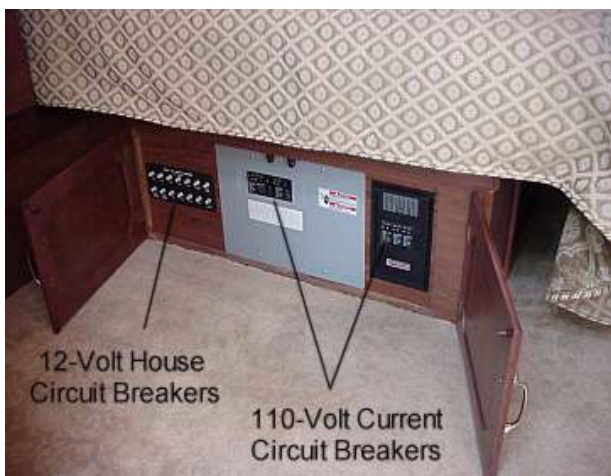

**Typical view of breaker panel. Actual breaker labels may vary according to appliance and equipment options. Fuses and breakers are labeled on panel.*

12-VOLT CHASSIS CIRCUIT BREAKERS

The 12-volt automotive and coach circuit breakers are located on a panel in the driver side front cargo compartment. See page 9-7 for further information.

Auto Chassis 12-Volt Breaker Panel



Automotive/Chassis Electrical Center
(Left Front Compartment)

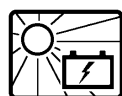

SOLAR CHARGER PANEL

The 10-watt roof-mounted solar charger panel uses the sun to help keep your batteries charged. A charge indicator light is located on the OnePlace monitor panel.

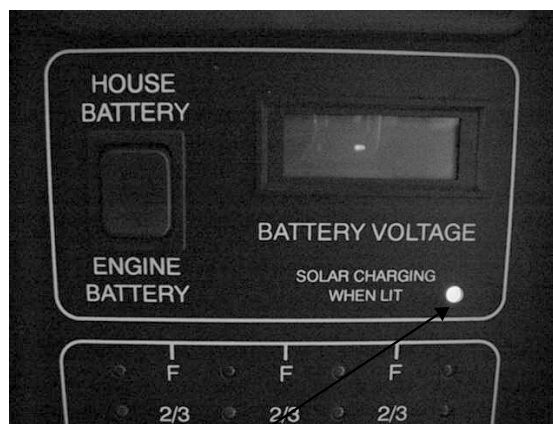

Solar Panel
Charge Indicator

The indicator light will glow when the solar panel is charging the coach batteries. The greater the rate of charge, the brighter the light. When the batteries reach full charge, the light will gradually dim, then darken.

NOTE: The solar battery charger is not intended to make the coach battery system “maintenance free.” The solar panel will not completely compensate for continuous low amperage draw from components such as the LP gas leak detector, the clock in the dash radio and the radio station memory circuitry, for example.

Although the solar panel system can help to extend battery life, the coach shoreline should be plugged in occasionally to “top off” the batteries. We also recommend following regular battery inspection and maintenance, especially in cold weather.

See “Battery Maintenance” on page 6-11 this section.

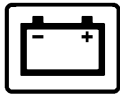

BATTERY INFORMATION

CHASSIS (Starting) BATTERY

The chassis batteries are used solely to operate the engine starter and all automotive accessories and controls found on the instrument panel. This includes the horn, speed control, all exterior lights, radio, windshield wipers, rear auto heater fan, etc.

Chassis Battery Storage: The chassis (starting) batteries are located in a slide-out tray in the battery compartment on the right side of the coach. (See Exterior Features Identification on page 0-4 of the Introduction section.)

Lift the retainer catches that hold the battery tray and slide it outward for service.



Chassis Batteries

House Batteries

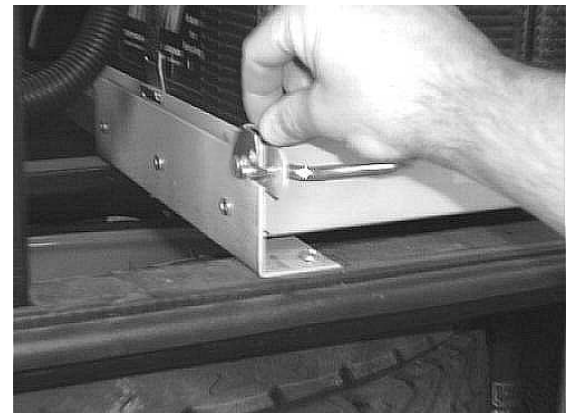

Lift Battery Tray Retainer Latches

HOUSE BATTERIES

The house batteries supply current to all 12-volt equipment located in the living area of the coach. This includes interior lights, range exhaust fan, furnace fan, water pump, water level and holding tank gauges, 110-volt generator starting, refrigerator and bath roof vent fan. The house battery may also be used to start the engine if the automotive battery is dead. Refer to “Aux. Start Switch.”

The house batteries are automatically charged by the engine alternator while the engine is running.

House Battery Storage

The batteries are also located in the battery compartment on the left side of the coach. See “Chassis Battery Storage” for access instructions.



BATTERY STORAGE AND MAINTENANCE

Lead -acid type batteries are electro-chemical devices for storing and releasing electrical charge. As such, they are simply an electrical reservoir, not an electrical source. As soon as energy is removed from the battery, it should be replaced by the engine alternator or the RV converter system.

If a battery sits unused for 30 days or more, especially during warm weather, it can develop a deposit of sulfate crystals on the metal plates inside the battery. This condition is called sulfation or sulfating, and prevents the battery from either releasing or accepting a charge. If this condition occurs, the battery must be replaced.

If a battery does not contain at least 80% charge during freezing temperatures, the electrolyte can freeze and crack the battery case.

The two best defenses against either sulfating or insufficient charge are:

1. To disconnect the battery cables to avoid any “parasitic” discharge, and
2. to check the battery and recharge as necessary at least once a month during long periods of storage.

A further precaution is to remove the battery from the vehicle and store it in a cool location on a wooden or rubber pad, checking charge periodically to avoid discharge or sulfating.

To ensure that the battery will always accept and hold a charge, follow these simple maintenance practices.

- Make sure the batteries always remain securely clamped in the battery tray.
- Make sure battery cable clamps are tight on the terminal posts and are free of corrosion.
- Neutralize corrosion buildup or acid film on top of battery by washing with a baking soda/water solution. Rinse with clear water.

NOTE: Make sure vent caps are on securely to prevent baking soda solution from entering the battery and contaminating the electrolyte fluid.



WARNING

Before removing any battery cables or battery, make sure all 12-volt equipment in the motor home is off and the power cord has been disconnected.

Replace any damaged cables at once. Always remove jewelry and wear protective clothing and eye covering when checking or handling batteries.

- Clean and tighten battery terminals and have the specific gravity checked at least once a year.



WARNING

California Proposition 65 Warning: Battery posts, terminals and related accessories contain lead and lead compounds, chemicals known to the state of California to cause cancer and reproductive harm. Wash hands after handling.

- Every two months, or more often in hot weather, check the battery fluid level. Fill to approximately 3/8 inch above the plates. **DO NOT OVERFILL.** If fluid is added during freezing weather, the motor home should be driven several miles to mix water and electrolyte to prevent freezing.
- Fluid level check may be omitted if equipped with maintenance-free batteries.

WARNING

To prevent wiring damage, it is essential when replacing the cables on the battery, or when using a “booster” battery, that the positive post and the positive cable be attached and the negative post and negative cable be attached. The posts are marked (+) plus and (-) minus. If a “fast charger” is used while battery is in the motor home, disconnect both battery cables before connecting the charger. Never attempt to charge or boost a frozen battery.

The connector plug is supplied in the coach parts package provided to you by your dealer when you took delivery of the vehicle.

The diagram below shows proper connection of trailer or tow vehicle wiring to the coach light system. To access the wire connections inside the plug, remove the small screw near the end of the plug and slide the contact assembly out of the barrel.

- TM = Tail lights
- GD = Ground
- LT = Left Turn
- RT = Right Turn
- S = Brake lights
- A = Backup lights

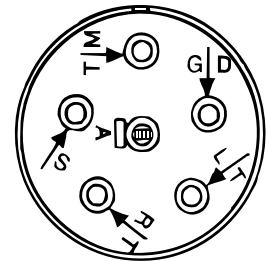

HOUSE BATTERY REPLACEMENT

This coach is equipped with deep-cycle type batteries designed for recreational vehicle use. They will provide longer lasting power than standard automotive batteries, and will withstand the frequent drain-and-recharge cycles that occur under the demanding conditions of RV usage.

Replacement batteries should be deep-cycle type with equivalent specifications to avoid loss of electrical storage capacity.

- Deep-cycle
- 130 Amp Hr.
- 225 minutes reserve capacity
- 665 CCA (cold cranking amps)

BATTERY CONDITION METER

See related item under “Monitor Panel” in section 8, Appliances.

AUX. START SWITCH

See section 2, Driving Your Motor Home for information on Aux. Start Switch.

TRAILER WIRING CONNECTOR

Your coach is pre-wired for trailer or car towing lights with a 6-pin socket on the rear bumper.

FRESH WATER SYSTEM



Fresh Water Tank..... 99 gal.

The fresh water system provides water to the galley sink, shower, bathroom lavatory, toilet and water heater. Water may be supplied by either of two sources:

- a water tank located within the motor home, or
- any external water source to which the motor home may be connected, known as “city water”.



Water Center

FRESH WATER TANK FILLING

PROCEDURES:

Always fill the fresh water tank at an approved potable water filling facility or a known purified drinking water source.

To Pressure Fill Water Tank from City Water Connection:

1. Attach a hose from a city water faucet to the city water connector in the water center on the left (driver) side of your coach.
2. Turn the tank fill valve to the WATER TANK FILL position.



3. Tank is full when water begins to flow from the overflow vent tube beneath the coach.

NOTE: Because city water pressure varies from location to location, we recommend using an in-line water pressure regulator to prevent damage to any components, connections and seals in your fresh water system.

A water pressure regulator may be obtained from any well stocked RV dealership retail center and some retail discount centers. These devices simply connect in-line between the supply hose and the city water input on the coach.

*We recommend a regulator that controls water pressure to **40 psi maximum**.*

NOTE: Always keep the tank fill valve closed unless you are filling the tank. If this valve is open while using the city water, the water will keep flowing into the tank and out the tank overflow tube.



WATER PUMP

Pressure for the water system is supplied by a water system demand pump which is fully automatic after initial priming. When a faucet is opened, the pump begins operation to provide a constant flow from the tank. When the faucet is closed, the pump automatically shuts off.



Water Pump

Pump Strainer Filter

The pump is equipped with a cleanable strainer filter to capture any possible tank borne particles that could damage pump components.

NOTE: We recommend that you check and clean this filter after each tankful of water during the first few uses of the water pump system. Thereafter, remember to check it at least yearly, such as during winterization procedures.

Press cover in firmly and twist counter-clockwise to remove



Water Pump Strainer

To Clean Pump Strainer

- Push the flat inlet cover in towards the rounded bowl section and twist counter-clockwise about 1/4 turn to disengage from locking tabs.
- Remove the cap, then pull the strainer out of the bowl. Tap out any particles and rinse clean.
- Insert the strainer back into the bowl, then twist the cap back into the bowl assembly to close.

Water Pump Switch

Your coach is equipped with water pump switches in three convenient locations:

- on the monitor panel (see section 8)
- in the utility service compartment on the outside of the coach

While any pump switch is in the “ON” position, the pump will automatically supply water pressure as it is needed. It is recommended that the pump switch be turned off whenever you are away from the vehicle or not using the water system. A slow leak in a faucet could drain the water system and discharge the coach battery.



Initial Start-Up

1. Make sure that all water drain valves are closed, including water heater valve. (Refer to Section 10.)
2. Turn water pump switch to “OFF” position.
3. Fill water tank.
4. Open all faucets, hot and cold.
5. Turn on pump switch.
6. Close each faucet as it begins to deliver a steady stream of water (close cold water first). Leave hot water faucets on until they also deliver a steady stream of water. This will ensure that the water heater is filled with water.
7. Check to be sure pump stops soon after all faucets have been closed.
8. Pump is now ready for automatic operation. Pump will start when a faucet is opened and stop when the faucet is closed.



Accumulator Tank

*NOTE: The accumulator tank has a precharge pressure which must be **checked monthly** and maintained at **20 psi** for the system to work properly.*

ACCUMULATOR TANK

A pressurized accumulator tank is installed in the water line directly upstream from the water pump located in the water pump compartment on the right side of the coach.

The accumulator tank holds a small amount of water under pressure of 20 psi to reduce water line pulsation noise and pressure variations when using the water pump system. This also contributes to longer pump life, less pump cycling, and less amperage draw by the water pump from the coach batteries.

Adjusting Precharge Pressure

A tire-type valve stem is provided on the end or top of the accumulator tank to check or add air pressure. (Note arrow in above photo.)

When adding air, do not exceed 20 psi tank precharge pressure because you may risk rupturing the pressure bladder inside the accumulator tank.

Because of the relatively small capacity of the bladder, check pressure with a standard tire pressure gauge before adding air, then if necessary, add air in small bursts, checking pressure between each burst until 20 psi is attained.

Overfilling will also push the bladder too far and reduce the volume of water held in the accumulator tank, making the system inefficient.

The precharge valve stem cap **must be tight** to prevent pressure leak-down.

Further Information

See manufacturer’s information supplied for your Owners InfoCase for complete maintenance instructions and precautions.



INSTRUCTIONS FOR DISINFECTION OF FRESH WATER SYSTEMS ON RECREATION VEHICLES

(As approved by the U.S. Public Health Service)

To assure complete disinfection of your fresh water system, it is recommended that the following procedure be followed on a new system, one that has not been used for a period of time, or one that may have become contaminated. This procedure is also recommended before long periods of storage such as over winter.

1. Prepare a chlorine solution using 1 gallon of water and 1/4 cup of household bleach (sodium hypochlorite solution). With tank empty, pour chlorine solution into the tank. Use 1 gallon solution for each 15 gallons of tank capacity. This procedure will result in a residual chlorine concentration of 50 ppm in the water system. If a 100 ppm concentration is required as discussed in item 3, use 1/2 cup of household bleach with 1 gallon of water to prepare the chlorine solution. One gallon of the solution should be used for each 15 gallons of tank capacity.
2. Complete filling of tank with fresh water. Open each faucet and run the water until a distinct odor of chlorine can be detected in the water discharged. Do not forget the hot water taps.
3. Allow the system to stand at least 4 hours when disinfecting with 50 ppm residual chlorine. If a shorter time period is desired, then a 100 ppm chlorine concentration should be permitted to stand in the system for at least 1 hour.
4. Drain and flush with fresh water.



WARNING

Chlorine is poisonous - recap bottle and clean utensils after use.

Never use automotive type antifreeze in your potable water system as it is poisonous.



EXTERNAL WATER SUPPLY (“City Water”)

To connect to an external source:

1. Turn the demand pump switch to off.
2. Pull a sufficient amount of hose from the water center hose reel and attach to an external city water faucet.



3. Turn water center diverter valve to CITY WATER position.



4. Turn on the external water source.

When connected to an outside source of water, the water bypasses the demand pump and storage tank and supplies pressure directly to individual faucets and toilet. A check valve built into the pump prevents water from entering the pump and filling the storage tank.

To disconnect from the external source:

1. Turn the external source off.
2. Open a faucet inside the vehicle to relieve line pressure.
3. Disconnect the hose from the vehicle and replace the cap on the connection.

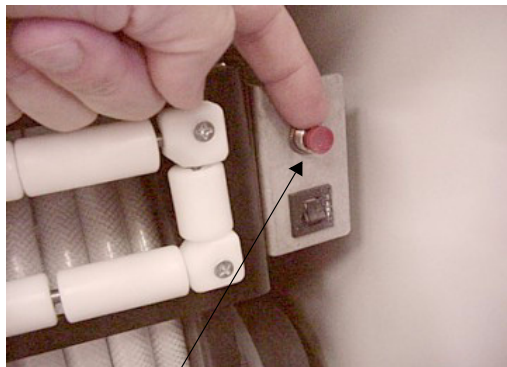

Press Red Button to Retract Hose



**WATER PURIFIER
(FILTER) SYSTEM**



Filtered Water Faucet

The water purifier system uses a flow-through activated carbon filter that removes chlorine and other impurities, resulting in clean, taste-free and odorless drinking water.



Water Filter Assembly -
Below Galley Sink

Replacing the water filter cartridge:

Replace the filter cartridge when water flow from the purifier faucet is too slow for convenience.

- Place a container beneath the filter to catch any remaining water during removal.
- Raise the valve handle near the top of the filter base to block water flow to filter.



- Twist the filter cartridge counterclockwise about a quarter-turn and pull it down and out of the filter head.



- Insert a new water filter cartridge up into the filter head as far as possible and turn it clockwise a quarter turn.
- Lower valve handle to lock filter and restore water flow.

See “Winterizing the Water Purifier System” in Section 10.

SHOWER HOSE VACUUM BREAKER

After using the shower, you may notice water dripping from the shower faucet assembly. The dripping results when vacuum in the shower hose (after closing the shower faucet) slowly releases and allows water remaining in the hose to drain down. This is a normal function of the shower valve assembly and is not a leak or defect.

The International Association of Plumbing and Mechanical Officials Standard TSC 21-85 (PAR. 4.3) states:

“Shower heads which incorporate shutoff valves, shall have a minimum “drip rate” of one (1) quart in thirty (30) minutes.”

NOTE: If items are placed into the shower tub before shower valve vacuum release is complete, they may become wet.

The label shown below is attached on or near the faucet to explain the operation of the vacuum breaker assembly.

For your protection, this faucet is equipped with a vacuum breaker (back flow preventer) to prevent contamination of your potable water supply. The water in the hand held shower hose will drain through this vacuum breaker when the faucet is turned off. This is not a leak. This drainage is inherent in the design of the vacuum breaker, and is evidence that it is functioning properly.

P.P.I. 0387

EXTERIOR SHOWER

The exterior auxiliary shower feature allows you to do things such as rinse off sand or salt after a swim, rinse off muddy boots, or bathe your pet outside the coach.

It is located in the water center compartment. For your convenience, there is also a soap dispenser and paper towel dispenser.

Exterior Shower

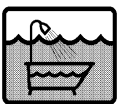

WASTE WATER SYSTEM (HOLDING TANKS)

The drainage system is self-contained and uses two separate holding tanks to contain the waste water until it can be dumped at an appropriate waste water disposal site. This means you can use the toilet, sinks and shower even in areas where utility hookups are not available.

The main holding tank contains the sewage from the toilet, and is commonly called the *Black Water* tank. The second holding tank contains the waste water from the galley sink, bathroom lavatory and shower, and is commonly called the *Gray Water* tank.

DUMPING HOLDING TANKS

1. Attach the drain hose and place end of sewer hose into disposal opening.
2. Open the sewage (Black Water) valve with a quick pull. OPEN ONE VALVE AT A TIME. Move hose gently about to dislodge any waste and to ensure complete drainage.

NOTE: Do not open the gray tank valve until the Black tank is drained and dump valve closed to avoid sewage back-up into Gray tank. Gray water also rinses any Black water solids from the drain hose.

1. Pull to drain black tank



Waste Drain Outlet

Waste Hose Storage

2. Pull to drain grey tank

3. Close sewage valve and open waste (Gray) Water dump valve with a quick pull. Close valve handle as soon as tank is empty.
4. After both tanks have been drained, run several gallons of water into the sewage tank through the toilet. Then open sewage dump valve and drain the tank again. Close valve when done.

5. It is advisable to add an odor control chemical to the sewage holding tank. These chemicals are available at most R.V. stores.
6. Rinse end of sewer hose thoroughly with water and stow.

NOTE: We recommend that you dump all holding tanks before traveling to avoid carrying unnecessary weight.



Flushing your Black Water Holding Tank

The black water holding tank is equipped with an internal spray head that allows you to rinse the inside of the tank with a shower of clean water after dumping.

1. Dump your black water holding tank in the usual manner at approved sewage disposal station.
2. Leave black water dump valve open while flushing tank.
3. Attach a garden hose from a city water hydrant to the Waste Tank Flush inlet in the water system compartment. (This inlet is clearly marked separate from the City Water inlet.)



Black Tank Flush Inlet

4. Turn the water on to begin flushing; allow water to run for about three minutes.
5. Disconnect hose from flushing system fitting and close dump valves.

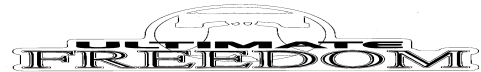

See page 8-7 for further information on the monitor panel functions.

USING ON-SITE SEWER HOOK-UPS

The drain hose may remain attached to the dump outlet and be routed out the bottom of the compartment while the motor home is parked and connected to an on-site sewage hook-up.

When using a sewer hook-up, keep the dump valves closed until a tank becomes full or when preparing to leave the site. This keeps the solids in suspension, allowing them to be carried out with the liquids when the dump valve is opened. If the valve is left open, the liquids will drain off, leaving solids in the tank. Should this accidentally happen, disconnect the hose, fill the tank about half full with water, and drive a few miles to dislodge the solids. A few starts and stops will aid in the process. Then reconnect the hose and drain in the normal manner.

UTILITY LIGHT

A lamp is located up on the left sidewall to provide light in the utility hook-up area.

The switch is located inside the shoreline/sewage compartment on the left side of the coach.

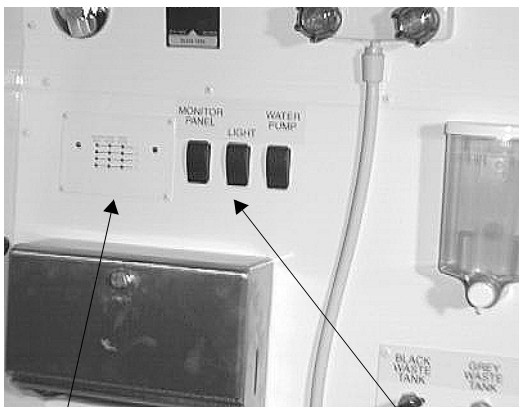

Tank Monitor Panel

Panel, Light & Pump Switches

TANK MONITOR PANEL

Holding tank levels may be viewed on the main systems monitor panel inside the coach, or on the convenient tank level indicator panel in the water center compartment.

Press the “Monitor Panel” switch to check the level in all tanks.

WATER DRAIN VALVES

The water drain valves are used to drain water from the water tank and the water supply lines when preparing the motor home for storage or when sanitizing the water system.

To Drain Tanks and Water Lines:

The water line drain valves are located in the water pump compartment on the passenger side toward the rear of the coach. Turn the valves as indicated in the following illustration, according to the type of valve installed.



Water Line Drain Valves
(in water pump compartment)

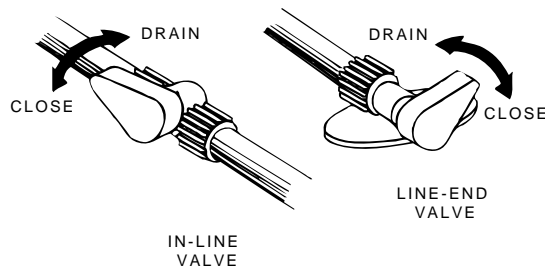

Water Drain Line Valves
(typical)

The water tank drain valve is operated by pulling a T-handle near the holding tank valves in the water center compartment.

- Open both Hot and Cold water line valves.
- Turn water diverter valve to WATER TANK FILL position.
- Open shower line drain valve inside coach.
See below.

TANK CAPACITIES



Black Water Holding Tank (Toilet)..... 50 gal.



Grey Water Holding Tank (Galley, Shower & Lavatory)..... 54 gal.



(See also Safety Precautions, Section 1 of this manual.)

NOTE: Some items described in this section may be optional and, therefore, may not be in your vehicle.

The appliances installed in your motor home are manufactured by reputable RV appliance makers and have been tested by independent laboratories to meet all applicable standards and codes set for RV appliances. These appliances are covered by your New Vehicle Limited Warranty. (Certain items may be covered by individual manufacturer's warranty.) See your New Vehicle Limited Warranty for details.

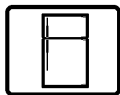

REFRIGERATOR

The refrigerator in your coach can be operated from either of two power sources available to the motor home:

- 110-Volt AC electric
- LP gas

The refrigerator is an absorption type which uses an ammonia-water solution for cooling. Basically, ammonia vapor is distilled from the solution by heat, produced from either LP gas or electricity and then carried to the finned condenser where it liquefies. The liquid then flows to an evaporator where it creates cold temperatures through evaporation.



Push door handle downward and pull to open refrigerator. (Lift freezer handle upward.)

Leveling

Before operating the refrigerator when the motor home is stationary, place a small level on the freezer plate and make certain the unit is level.

Normal vehicle leveling to provide comfort for the occupants is satisfactory for refrigerator operation. This will be well within the operation limits of 3° off-level side-to-side and 6° off-level front-to-back.



CAUTION

To prevent permanent damage to the refrigerator cooling unit, turn the refrigerator off if the vehicle will be parked on an incline of **over 3° side-to-side or 6° front-to-rear** (such as steep driveways or parking lots, etc.) for more than one hour.



WARNING

Most LP gas appliances used in recreational vehicles are vented to the outside of the vehicle. When parked close to a gasoline pump, it is possible that the gasoline fumes could enter this type of appliance and ignite from the burner flame, **CAUSING A FIRE OR AN EXPLOSION.**

FOR YOUR SAFETY, it is recommended that all LP gas appliances which are vented to the outside should be shut off when refueling.

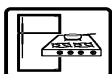

OPERATING INSTRUCTIONS

Norcold 1200-Series Models with Electronic Auto Mode Control

The control panel is located between the freezer compartment and fresh food compartment. It contains pressure sensitive touch switches and a digital display. A backlight illuminates the display for 10 seconds whenever any of the control buttons is pressed.

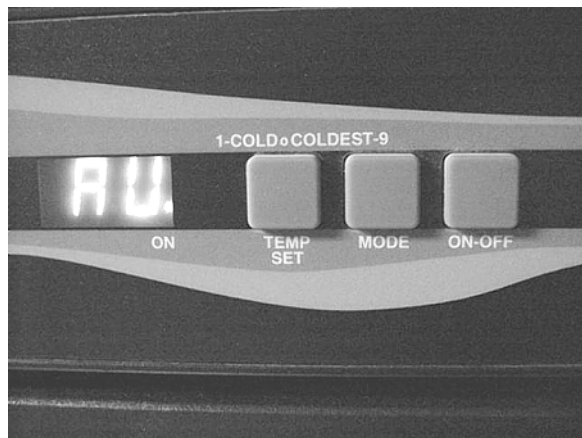

The ON/OFF button turns the refrigerator on or off. If the button is pressed, it will turn the refrigerator on and set the mode to auto. When the refrigerator is on, pressing this button for 2 seconds will turn the refrigerator off.

Pressing and holding the MODE button allows the user to cycle through the three mode choices; one AUTO and two manual modes (AC, LP GAS). The refrigerator will not switch to the new operating mode until the mode button is released.

The TEMP SET (thermostat) button controls the refrigerator and freezer temperature during both gas and electric operation, eliminating the need to reset each time a different power source is selected. Press and hold the TEMP SET button to select the desired temperature setting. The temperature settings are shown in the form of a number (A) in the display window, with the highest number indicating the coldest setting.

Start-Up Instructions - Auto Mode

When the AUTO mode is selected, the operating control automatically selects the power source using the following priority scheme:

- First, the auto mode system will ‘seek’ to find AC power available. At this time ‘AU’ will appear in the display window.
- When 120 volts AC is available to the refrigerator, ‘AC’ will appear in the display panel, indicating the refrigerator is operating on AC electric.
- If 120 volts AC is not available, the refrigerator will switch to the gas operation, and ‘LP’ will appear in the display panel.

During operation in the AUTO mode, when a higher priority power source becomes available, the operating controls will cease using the current power source and will switch to the higher priority power source. For example, if AC electric becomes available while the refrigerator is operating in the AUTO LP GAS mode, the refrigerator will switch to AUTO AC operation.

If an operating mode is not functional, a diagnostic code will appear and the refrigerator will attempt to operate in a lower power priority source. If a lower power priority source is not available, an alarm will sound and the refrigerator will cease operation. Refer to the *Diagnostic Codes and Their Meaning* for corrective actions.

Start-Up Instructions - Manual Mode

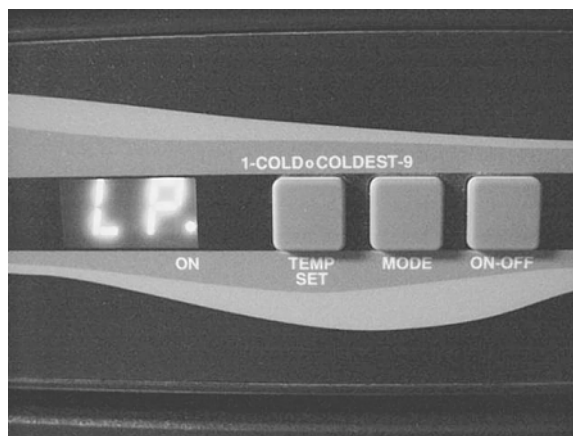

To operate in the MANUAL mode, press and hold the MODE button until AUTO disappears and the desired operating mode is displayed. If the power source is interrupted while operating in the MANUAL mode, a diagnostic code will

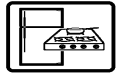

appear, an alarm will sound, and the refrigerator will cease operation. For corrective actions, refer to the *Diagnostic Codes and Their Meaning* on page 10 of the Norcold Operator's Guide in the blue binder.

AUTO and MANUAL Modes - Gas Operation Only

If the gas does not ignite within 30 seconds, which may occur on initial start-up, the refrigerator's gas valve will automatically close and the operating controls will select an alternate power source (AUTO Mode) or MANUAL mode, will revert to a stand-by mode in which an alarm will sound and code A1 will be displayed in the center window. The alarm and code will remain on until the operating controls are turned OFF and then ON again. If the gas does not ignite after several attempts, check the input gas supply, or consult with your dealer or a Norcold authorized service center. A different mode of operation may be selected by pressing and holding the MODE button. The refrigerator will not switch to the new operating mode until the MODE button is released.

Backup Operating System (BOS)

Your refrigerator features a Backup Operating System which keeps the refrigerator cool in the event of a failure of the refrigerator's operating controls. If a failure occurs, the refrigerator will display Diagnostic Code C5 and will switch automatically to the BOS mode. This mode provides refrigeration until the refrigerator is serviced. The fresh food and freezer compartment temperatures should be monitored to prevent over-freezing or thawing of refrigerator contents when operating in the BOS mode. If the refrigerator temperature is too cold, adjust the thermostat up (warmer) in one bar increments. If the refrigerator temperature is too warm, adjust the thermostat down (colder) in one bar increments. Let the refrigerator operate at the new setting for one hour before rechecking the freezer and fresh food compartment temperatures. (Frequent door opening prevents the temperatures from stabilizing.) Although the refrigerator can operate in this mode, Norcold recommends that you seek

service to restore normal operation as soon as practical.

Humidity - Storage Switch

Turning this switch to HIGH HUMIDITY will keep the surface between the door openings dry during high humidity conditions. The switch should be left in the NORMAL OPERATION position unless moisture collects around the door.

When storing your RV for the winter, place this switch in the STORAGE (LIGHT OFF) position. This shuts off all DC power to the light and humidity heater and allows the refrigerator door to be left open for airing without draining the battery.

Operating Tips

- The refrigerator should already be cold before placing items in it.
- Food and beverages should also be cold before placing in RV refrigerator. Never put warm or hot items in a cold refrigerator.
- Do not pack the refrigerator too full. The refrigerator needs room for cold air to circulate.
- Use smaller containers for each item. (e.g. a half gallon container of milk instead of a half-full gallon jug)
- Always put foods, especially liquids, in tightly sealed containers.
- Use crumpled paper between loose items to reduce rattling or "clinking" noises.

ICE MAKER - Norcold

Some Norcold refrigerators are optionally equipped with an automatic ice maker system. The ice maker unit is installed in the freezer compartment of the refrigerator.

The ice maker does not freeze the ice. The refrigerator freezer compartment does the actual freezing of the water. The ice maker simply senses when the ice is ready, ejects it into the ice bin, and refills the molds with water for another ice cycle. When the ice bin is full, the amount of ice will raise an automatic shutoff arm which stops the ice maker. Some problems involving lack of ice production - particularly a lack of freezing - may be the fault of the refrigerator rather than the ice maker.

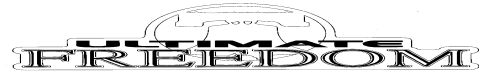
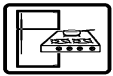

Operating the Ice Maker

1. Connect the coach shoreline to a 110VAC source and switch the refrigerator to AUTO (AC electric) mode. The ice maker motor runs on 110-volt current only.
2. Connect the coach to an external (city water) source or leave water pump switch on continuously to provide a constant water supply.
3. Be sure the ice bin is in place and the ice maker's automatic shut-off arm (wire) is in the down (automatic) position. If the arm is up, the ice maker will not operate.

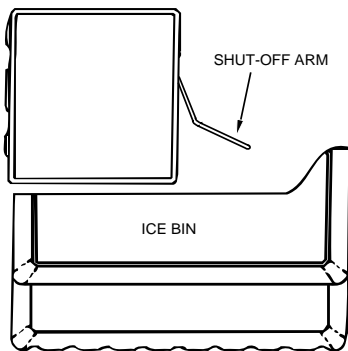
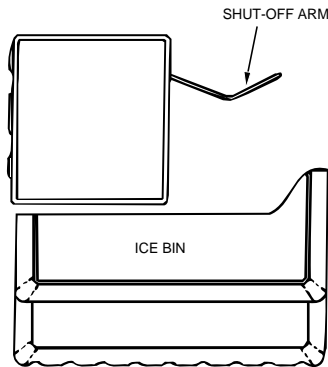

bin to the freezer, remember to lower the shut-off arm (on). If the arm is up, the ice maker will not operate.

Shut-Down of Ice Maker

To turn the ice maker off, simply raise the shutoff arm (wire).

Winterizing the Ice Maker

When winterizing, make sure the water line is completely drained by following this procedure.

1. Drain coach water lines. See Sect. 10.
2. Unscrew the water supply line from the bottom of the water inlet valve and drain any water left in the line. This connection is located in the refrigerator service compartment on the outside of the coach. (See Refrigerator Service Access Compartment on the following page.)

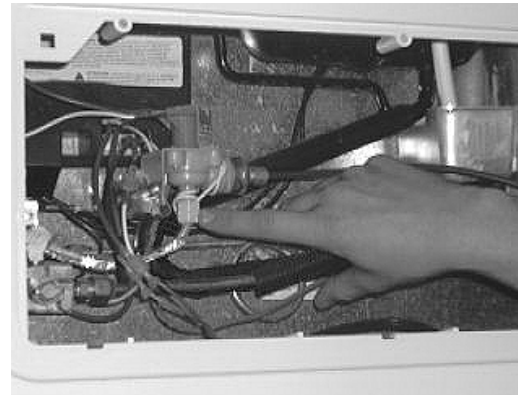

Ice Maker Water Supply Connection

4. Start the refrigerator the day before ice cubes are needed. When the refrigerator is started (from room temperature), it is normal to take as long as 24 hours to become cold enough to make the first batch of ice cubes.
5. Always discard the first batch of cubes made in a new ice maker. The new plumbing lines and connections may cause discolored and bad tasting ice. The ice maker will make up to 3 lbs. of ice in 24 hours, if the freezer temperature is 14 F or below.
6. To remove the ice bin, raise the automatic shut-off arm (off). When returning the ice

3. Let the ice maker run through a cycle, then raise the shut-off arm.
4. Be sure water has drained from ice maker supply line, then reconnect to inlet valve.

Start-Up (Removing from Storage)

1. Close all drain valves.
2. Turn the water supply on.
3. Be sure the ice bin is in place and the automatic shutoff arm is down.
4. Let the refrigerator cool down to ice making temperature. Remember, this can take up to 24 hours.

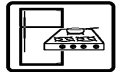

5. Let the ice maker cycle and dump the first batch of ice.

Troubleshooting the Ice Maker

1. Is 110-Volt AC reaching the refrigerator?

- A. Ice maker motor needs 110VAC to operate.
- B. Be sure refrigerator power cord is plugged in.
- C. Check appropriate breaker on 110VAC breaker panel.

2. Is 12-Volt DC reaching the refrigerator?

- A. Refrigerator eyebrow control and power supply board both need 12VDC to operate.
- B. Check 12V fuse or breaker on converter panel

3. Is water supply pressure at least 15 psi, but no more than 125 psi?

- A. If not enough, turn city water faucet open further or check for blockage.
- B. If too much, attach water pressure regulator.

4. Is the water supply inlet valve on?

- A. If not enough, turn city water faucet open further or check for blockage.
- B. If too much, attach water pressure regulator.

5. Is the freezer compartment temperature 14° F or lower?

- A. Turn refrigerator temperature control to colder setting, if needed.

6. Is the ice maker's automatic shut-off arm in the down (on) position?

- A. If arm is not down, ice maker will not operate.

7. Has it been at least 24 hours since the refrigerator was turned on?

- A. If not, allow more time.
- B. If so, refer to Norcold refrigerator freezer troubleshooting procedures in your dealer service library.

8. Water not filling molds:

- A. Water inlet valve off (on back side of refrigerator).
- B. Insufficient water pressure.
- C. Water line blockage.
- D. Faulty water solenoid - stuck off.

9. Water over-filling molds:

- A. Excessive water pressure.
- B. Faulty water solution - stuck on.

10. Water not freezing:

- A. Refrigerator problem.

11. Ice not ejecting:

- A. 110VAC power not connected.
- B. Mold heater not working - replace ice maker.
- C. Ejector motor not working - replace ice maker.

12. Ice bin overfilling:

- A. Shutoff switch broken.
- B. Shutoff wire stuck.

13. Low ice production:

- A. Water not freezing fast enough - refrigerator problem.

14. Freezer needs defrosting often:

- A. Ice maker motor and mold heater add heat to compartment, which develops frost. This is normal.
- B. Check door gasket for proper sealing.

REFRIGERATOR SERVICE ACCESS COMPARTMENT

(Exterior)

The exterior refrigerator service compartment allows access to the rear of the refrigerator for inspection, maintenance and service.



Turn latches open with coin

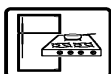

SECTION 8
APPLIANCES & INTERIOR FEATURES



Refrigerator Access Compartment

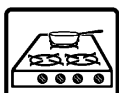

LP GAS COOKTOP

The cooktop in your motor home operates on LP gas and will provide the same functions that the range in your home does.



Gas Cooktop

The following warning label has been located in the cooking area to remind you to provide an adequate supply of fresh air for combustion.



Unlike large homes, the oxygen supply inside a recreational vehicle is limited due to its size. To avoid danger of asphyxiation, provide proper ventilation when using the gas cooktop. It is

especially important not to use the gas cooktop for comfort heating. Danger of asphyxiation is greater when these appliances are used for long periods of time.

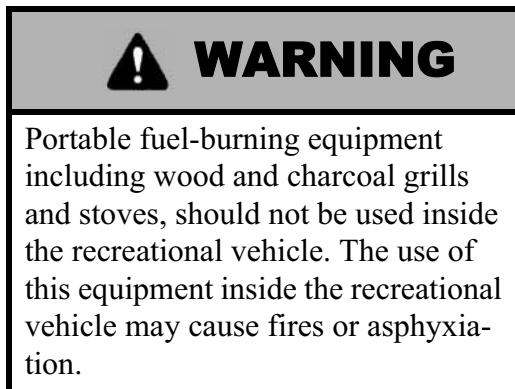

Lighting Cooktop Burners (w/Pilotless Ignition)

1. Be sure LP gas tank main supply valve is open.
2. Rotate the knob to the lighting bolt symbol to provide ignition spark.
3. When the burner lights, turn the knob back to adjust the flame height.

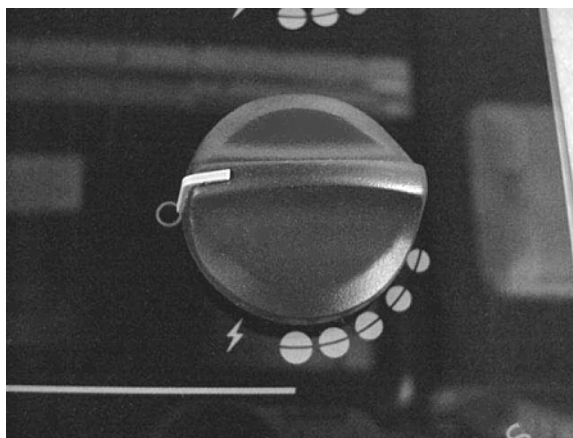

Rotate knob to lightning bolt (spark) to light burner.

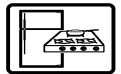

Further Information

See the Cooktop *Use and Care Guide* in your Owner InfoCase for more precautions, operating and care instructions.

MICROWAVE/CONVECTION OVEN

For complete operating instructions, refer to the manufacturer’s information provided with the oven.

RANGE HOOD

The range hood vent is built into the underside of the microwave oven. The range hood fan draws cooking odors and gas fumes through a filtering system and exhausts them to the outside of the coach. A light on the underside of the hood provides illumination for food preparation. The hood fan and light switches are located on the microwave control panel.



To Clean Grease Filter or Replace Light Bulb

See the manufacturer’s information in your Owner InfoCase for instructions on replacement of light bulbs and grease filter elements.



ONEPLACE™ SYSTEMS MONITOR PANEL

The ONEPLACE Systems Monitor Panel provides a convenient, central location for checking the condition of all utility systems in your coach. It also includes the TRUEAIR climate control thermostat and the POWERLINE Energy Management System status panel.

At the touch of a button this panel can display the fresh water and holding tank levels, LP gas tank level, plus the engine battery and coach battery condition. You can start the auxiliary generator or turn on the water pump and water heater. Indicator lights tell you if the water pump is on or if the water heater pilot light is out.



One Place Monitor Panel

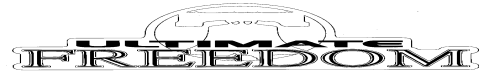
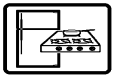

Generator Start/Stop Switch

See Section 6, Electrical Systems for generator start-up and shut-down instructions.



Generator Switch and Hourmeter

Generator Hourmeter

See Section 6, Electrical Systems for generator hourmeter information.

Water and Holding Tank Levels

Press and hold the “Levels Test” switch to show approximate level on the monitor lights.

The approximate water levels are measured by sets of electronic probes in the sides of the tanks, so the water must be touching a probe to register at that level. There is generally more water in a tank than indicated on the monitor panel.

For example, a water level of 1-2” below the FULL probe, the monitor will show the level to be only 2/3 even though the tank is nearly full. If the water level is below the 1/3 probe, the monitor will register an empty tank because the water is no longer touching the 1/3 probe. There may actually be some water left in the tank. However, when the indicator reads FULL, the tank is actually full.



Tank Capacities

See back of “To The Owner” page inside front cover of this manual.

LP Gas Level

Press and hold the “Levels Test” switch to show approximate LP tank level.

The LP level is registered by a sending unit on the tank. The gauge mounted on the side of the tank will give a more accurate indication of actual tank level if needed.

Water Pump Switch

When you want to use the self-contained water system, turn on the “Water Pump” switch on the monitor panel. The “Pump On” light will illuminate when the pump switch is turned on. Water will be available as soon as a faucet is opened.

For your convenience, additional switches are located in the bathroom and in the water center compartment.

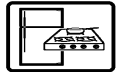

Water Pump
Switch

Battery Condition Meter

Press and hold the switch to display condition of either House Battery or Engine Battery. The LCD display will show the current battery voltage to the nearest tenth of a volt.

- A 12-volt battery typically registers anywhere from 12.5V to 13V when adequately charged.
- Voltage below 12.5V indicates a discharged condition; 12V or less is effectively 'dead'.
- Voltage above 13V typically indicates that the battery is being charged by the inverter charger system.

To get an accurate reading;

1. Both the chassis engine and the auxiliary generator engine must be shut off.
2. An interior light should be turned on to provide a small load which draws off the battery surface charge.



Dish Drawer Lock Feature

The Dish Drawer must be programmed to the 'Closed Drawer' option to keep the drawer locked while driving. See the Dish Drawer User Guide page 14 & 15 "Option adjustment mode" Integrated version.



1. Press the power button (left side of touch panel).
2. Open the drawer, then press the ECO button on the inside of the drawer and the Lock button (right side of touch panel) at the same time until you hear one long beep.
3. Press the start/pause button (center of touch panel) 3 times; the light above the button will be red.
4. Press the Lock button (right side of touch panel) to turn the "Closed Drawer" feature on. The lights on display panel inside of the drawer will light up.
5. Press the power button (left on touch panel) the unit is set.

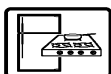

NOTE: If the power is disconnected and restored, the drawer will unlock then lock itself after 30 seconds. It will stay locked when power is disconnected and must have power connected to open.

To open the drawer in this mode, you must press the start/pause button.

WASHER-DRYER (Optional)

For complete operating instructions, see the manufacturer's information provided in your Owners InfoCase.



The washing machine water supply faucets are located inside the lavatory cabinet. Always turn supply faucets off when not using washing machine to avoid possible water leaks if a hose or hose gasket should fail.

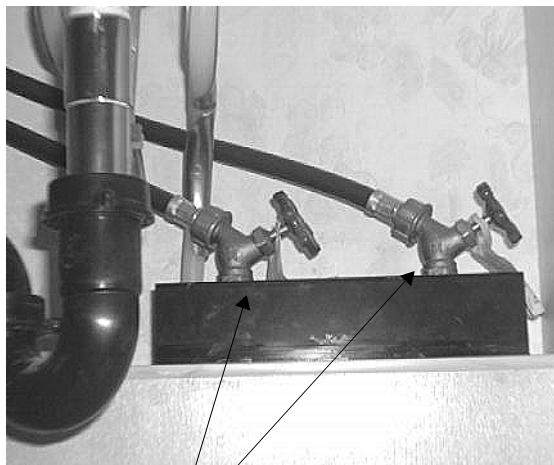

Water Supply
Faucets

HYDRONIC HEATING SYSTEM

Your new Ultimate Freedom has an advanced Hydronic Hot Water Heating System to provide dependable radiant heat throughout the coach. Dual thermostats and five individual radiators provide specific zone comfort as well as basement heating.

A hydronic heating system is a high-tech version of the old boiler and radiator systems used in many homes years ago. It uses hot water for central heating of your coach and to heat the water used for cooking, cleaning and bathing.

Dual-power capability enables the system to operate from shoreline 110-Volt AC or the onboard diesel fuel supply so you will have heat and hot water as you travel as well as in the campground.

The water is heated in a boiler using diesel fuel from the chassis fuel tank, with an electric heat element for supplemental heating. The water is then circulated to several fan-powered heat exchanger units at various locations in the coach.

Zones

There are five or six heat exchangers located in three different zones in your coach depending on model:

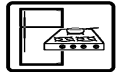

- Dash/Lounge/Galley area (3 heat exchangers on TrueTemp thermostat)
- Bedroom/Bath area (2 heat exchangers on bedroom thermostat)
- Basement compartment area (pre-set 'aquastat')

the heater unit control box in the heater compartment.

Continuous Hot Water

The hydronic system also provides continuous 1.5 gallons-per-minute of hot water (at approx. 106° F.) to the residential fresh water system so you can enjoy a long shower and wash that extra load of laundry.

Heat Exchanger (Engine Heat While Driving)

The heat exchanger feature allows the hydronic system to recycle normally wasted heat from the engine coolant and use it to heat the coach or the house hot water system while driving.

Engine Coolant Pre-Warmer

An added feature of the hydronic system is a built-in engine coolant pre-warm circuit. This means you will enjoy easier cold weather starts and reduce the stress on your engine, starter and batteries.

Operating Your Hydronic Heating System

Like conventional forced air furnaces, hydronic heating systems are controlled by thermostats. Each heat exchanger/fan unit heats a corresponding zone until the desired temperature is sensed by the thermostat and the fan shuts off.

It is important to remember when operating this system that turning the thermostat up will not heat the room instantly. Because radiant water heat is more evenly distributed than forced air, it may take some time to feel added warmth once you turn the thermostat up. Wait about 30 minutes after setting a thermostat before readjusting.

See Chapter 4 of the Hydronic Heating System manual included in your owner InfoCase.

Start-Up:

1. Turn on the main power switch located on



2. Turn on the On/Off control switch on the remote indicator panel inside the coach.

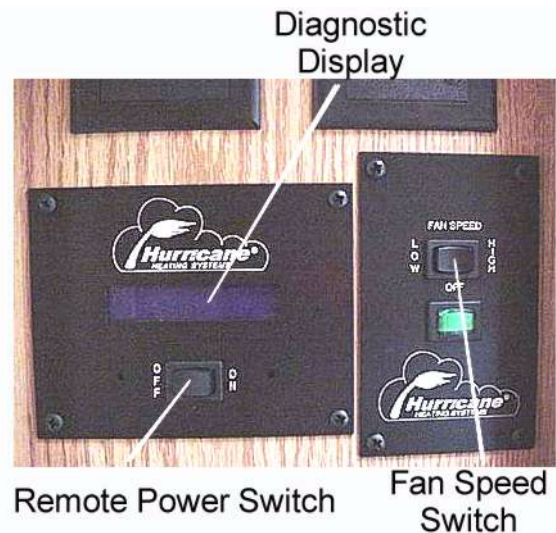

3. Slide the TrueAir THERMOSTAT system switch to 'Gas Heat', FAN MODE switch to 'Auto', and FAN SPEED switch to desired speed; 'Lo' or 'Hi'.
4. Adjust the zone thermostats for desired temperature in each zone.

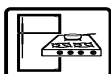

⚠ CAUTION

NEVER disconnect battery power to the hydronic heater using the Battery Disconnect Switch or circuit breaker while the heater is operating. Doing so may cause serious damage to the heater, which may not be covered under warranty. Always shut down the heater using the remote power switch before using the battery disconnect switch.

Air Compressor Fuel Pump Combustion Fan Motor	Seasonally	Inspect for Leaks, Corrosion and Wear
---	------------	---------------------------------------

Troubleshooting Your Hydronic System

If a problem develops with your hydronic heating system, the diagnostic display on the remote switch panel will give you a fault code. You can call the Rixen Enterprises toll-free technical hotline shown on the control box and they will guide you through the troubleshooting procedure. Most problems can be solved over the phone. Some problems may require an experienced technician. In these situations they will recommend that you see your dealer for service or maintenance of the system.

See Chapter 5 of the Hydronic Heating System manual included in your owner InfoCase.

Maintaining Your Hydronic System

Maintenance of hydronic systems is important to do on an annual basis.

Heat exchanger units need routine cleaning and vacuuming to ensure that the convective fins are free from dirt and lint.

The boiler and water heaters require routine maintenance as recommended by the manufacturer.

Because of the complexity of this system we recommend that you take your coach to your Ultimate Freedom dealer for annual maintenance and service, unless you are familiar with heating systems and electronic controls.

See Chapter 6 of the Hydronic Heating System manual included in your owner InfoCase.

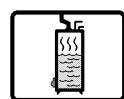

WATER HEATER

The residential fresh water system water heater is incorporated into the hydronic heater system. This system provides continuous 1.5 gallons-per-minute of hot water (at approx. 106° F.) following an approximately 3 1/2 minutes pre-heat time. This means you can enjoy a long shower and wash that extra load of laundry without running out of hot water.

MAINTENANCE SCHEDULE

Maintenance Item	Maintenance Frequency	Service Required
Fuel/Water Hoses	Seasonally	Inspect for leaks and Weak Points
Hose Clamps	Seasonally	Inspect for Corrosion Tighten if Loose
Combustion Chamber and Exhaust	1,000 hours - primary maintenance	Vacuum clean
Fuel Filter	Seasonally	Inspect for Cleaning or Replacement
Nozzles Distributor Orifice, Air Slots, and O-Rings	600 Hours - Primary Maintenance	Cleaning and Inspection for Wear and Damage
Exhaust System	Seasonally	Inspect for Leaks and Corrosion
Coolant Mixture	Every 3 years	Replace Check PH level for acidity
Electronic Control Panel	Seasonally	Voltage Test/Inspect for Corroded Wires

Start-Up

- Be sure the Water Heater main switch on the heater control box in the heater compartment is turned on.



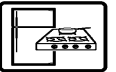

- Be sure there is water in the fresh water tank and demand pump is on or you are connected to city water.
- If the hydronic system is operating (remote power switch on) the water heater is operational.

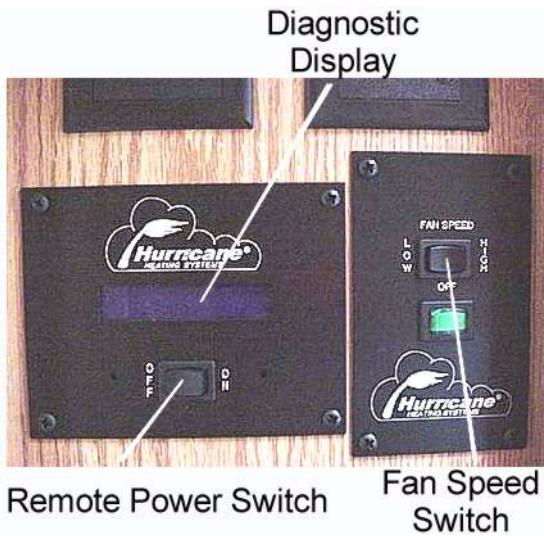

- If you are connected to shoreline power you can also turn on the electric heater element switches on the OnePlace center for supplemental heating.
- If you are connected to 50-amp power, both switches can be turned on.
- If you are connected to 30-amp power, only one switch may be turned on.

Shut-Down

- Turn off both electric water heater switches.
- Turn off the Water Heater main switch on the heater unit control box in the exterior compartment.



⚠ CAUTION

NEVER disconnect battery power to the hydronic heater using the Battery Disconnect Switch or circuit breaker while the heater is operating. Doing so may cause serious damage to the heater, which may not be covered under warranty. Always shut down the heater using the remote power switch before using the battery disconnect switch.

ELECTRONIC THERMOSTAT

(Central Heat/Air Conditioning System Only)

The thermostat, located in the galley area, controls heating, air conditioning and cooling fan features.

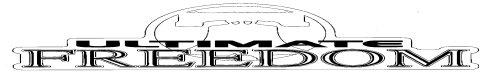
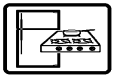

Temp Selector

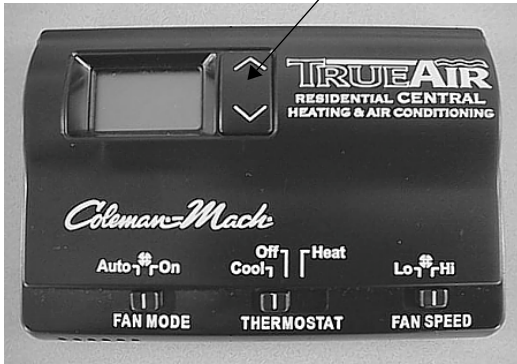

NOTE: The thermostat does not automatically switch between heating and cooling. You must place the switch in the desired position.

Heating:

- Slide the thermostat switch to “Heat” position.

NOTE: Follow proper hydronic heater start-up procedures described previously in this section.

NOTE: If your coach is equipped with the optional electric Heat Pump, be sure the Thermostat switch is in Gas Heat position. See Heat Pump for details.

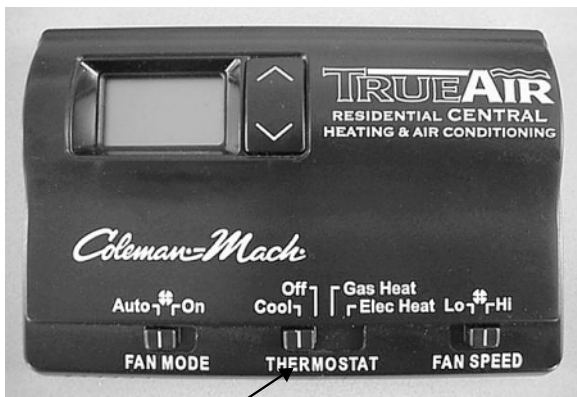

Heat Source Switch
ELECTRIC = Heat Pump
GAS = Furnace

- Adjust the temperature setpoint to personal preference if needed. See “Set Temperature”

below.

Digital Thermostat Display

The digital display normally shows current room temperature, with the word “ROOM” in small letters at the left side of the display. When you press the temperature selector button up or down, the display will show the word “SET” and the new temperature setpoint until you release the button.

Set Temperature

To set the temperature to a new temperature, simply press the Temperature Selector button up or down until the temperature you want appears in the display. The word “SET” will also appear at the left side of the display while you are changing the temperature setpoint. A few seconds after you release the temperature selector button, the display will return to showing the current room temperature.

Cooling (A/C):

- Slide the thermostat switch to Cool position.
- Slide the Fan Mode and Fan Speed Switches to the desired positions.

On/Low: A/C compressor cycles on and off with the thermostat while fan runs continuously at low speed.

On/High: A/C compressor cycles on and off with the thermostat while fan runs continuously at high speed.

Auto/Low: Fan runs at low speed and cycles on and off with the A/C compressor as controlled by the thermostat.

Auto/High: Fan runs at high speed and cycles on and off with the A/C compressor as controlled by the thermostat.

- Adjust the temperature setpoint to personal preference if needed. See “Changing Temperature Setpoints”.

To Run Fan Only (No Heat or Air)

- Set Thermostat switch to OFF.
- Slide Fan Mode switch to On.
- Place Fan Speed switch to Lo or Hi as desired

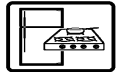

- The fan will run continuously at the selected speed and is not controlled by thermostat setting. The display will show current room temperature.

HEAT PUMP - Optional

Your coach may be optionally equipped with an air source heat pump built into the central air conditioning system. Because the heat pump operates on electricity, it provides economical heat inside your coach and helps reduce the use of LP gas for heating in cooler weather.

A heat pump can be thought of as an air conditioner running in reverse. An air conditioner absorbs heat from the air inside of the coach and moves it to the outside. The heat pump does exactly the opposite. Even cold air contains some heat, so a heat pump will extract heat from the outside air on a cold day and carry it to the inside of the coach to maintain a comfortable temperature.

The efficiency of a heat pump decreases as the outdoor air temperature drops, so supplementary heat is often needed when the outside temperature nears freezing. This system is set to automatically start the hydronic heater to assist the heat pump if room temperature cools to 5 degrees F or more below the thermostat setpoint. You may wish to manually switch to hydronic heat to maintain a higher temperature when outside temperatures begin to reduce the efficiency of the heat pump. The heat pump will not operate when the outside temperature falls below 36 degrees F.

To Operate the Heat Pump:

- Slide the thermostat switch to electric heat mode.
- If the inside temperature is 5 degrees or more below the thermostat set point, both the heat pump and the hydronic heater will run initially to bring the interior temperature up to the set point as quickly as possible. (If the inside temperature is 4 degrees or less below the set point, then only the heat pump will run initially.)
- When the thermostat calls for heat again, only the heat pump will run. The heat pump will remain the sole heat source unless it cannot maintain the inside temperature. If the inside temperature falls five degrees

below the set point, the hydronic heater will assist the heat pump until the set point is reached.

If the hydronic heater must assist the heat pump three times in a row, the thermostat will shut down the heat pump for two hours and the hydronic heater will take over as the heat source. After two hours the heat pump will become active again and try to be the primary heat source.

The hydronic heater acts as a standby heat source if the outside temperature drops below a point that the heat pump can no longer extract heat from the outside air to maintain the desired inside temperature.

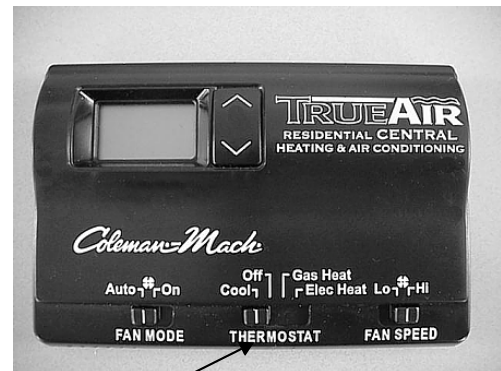

Thermostat Switch
 Gas Heat = Furnace Only
 Elec Heat = Heat Pump

Have you checked your air filter lately?

Closed or blocked vents and a dirty air filter can hinder the efficiency of a heat pump. See Air Conditioner Filter for location and instructions.

- Be sure ceiling vents are open to distribute heat pump output air. Also make sure furniture, clothing items, packages or other obstructions do not block the air return air grilles beneath the rear bed.
- The filter should be checked monthly for dirt build-up and replaced as needed. The air filter is a disposable woven fiberglass type, which cannot be cleaned and should be replaced when coated with dust.

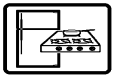

TRUEAIR
RESIDENTIAL CENTRAL AC

CENTRAL AIR CONDITIONER

NOTE: See “Electronic Thermostat” for instructions on turning the air conditioner on and changing the thermostat settings.

The central air conditioner is mounted in an exterior compartment on the left (driver) side of the coach. (See page 0-4.) The compartment door opens for easy maintenance and periodic service. (See “Condenser Coils”) The cooled air is forced through ducts in the ceiling of the coach. Inside air returns to the air conditioner through a filter system beneath the rear bed. (See “Air Conditioner Filters”.)

Air Conditioner Filter (Coach models 40ED & 40KD)

A disposable type filter is located in the floor beneath the passenger side washer/dryer or the rear wardrobe, depending on model as shown in the photos below. The filter should be inspected monthly to ensure efficient operation of the air conditioning system.



- Remove the drawer from the nightstand to access the filter.
- Lift the old filter out the floor frame.
- Lay the new filter back into floor frame, being careful to observe flow markings on the edge of the filter. The arrows should point downward towards the floor.

NOTE: Do not block the filter intake grate in any way by setting items such as packages, blankets, etc., in front of it. There must be free airflow for the air conditioner to operate efficiently.

Condenser Coils

The condenser is located in a compartment on the left side of the coach. The condenser is the large, black, rectangular area that looks like a car radiator.

Periodically sweep debris carefully from the fins of the condenser. Rinse dust off with clean water. The condenser coils must be clean and free of dust, debris and insect particles, etc., for the air conditioner to cool efficiently.

Further Information

See the air conditioner manufacturer’s operating instructions supplied in your Owners Info-Case. They contain detailed operating instructions, special precautions and basic troubleshooting.

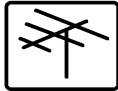
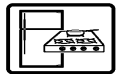

TV ANTENNA

The TV antenna on your motor home can be easily raised, rotated a full 360° and lowered from inside the vehicle by simply turning a crank or rotating knob. A built-in signal amplifier designed to strengthen signals, is controlled by a power switch built into the TV jack assembly.

The signal amplifier is housed inside the antenna with the circuit board connected directly to the antenna elements. Power to operate the amplifier (12-volt DC) is supplied through the download cable which also carries the TV signals to the TV set. The power supply separates the 12-volt DC from the TV signals and provides a place for attaching the TV set and the 12-volt power source.

Operation

Raising Antenna - Turn elevating crank clockwise in “UP” direction about 13 turns or until some resistance to turning is noted. Antenna is now in operating position. Turn amplifier power switch “ON” to receive TV signal.

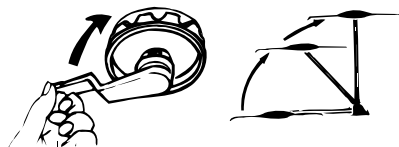

! WARNING

Never allow the antenna to touch electrical power lines or any other electrical wires.

Rotating Antenna - Make sure antenna is in the “UP” position. Pull down on rotating knob until it disengages ceiling plate and rotate for best picture and sound on TV set.



Lowering Antenna to Travel Position - Rotate antenna until pointer on rotating knob aligns with pointer on ceiling plate.

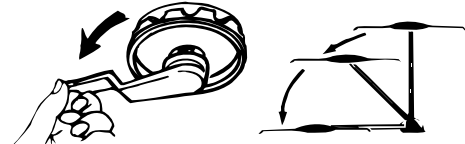

! CAUTION

Never leave the antenna partially raised or partially lowered. This can damage the crank mechanism gears. Always raise the antenna straight up or lower it completely into the travel position.

Turn elevating crank (counterclockwise) in “DOWN” direction until resistance is noted. Antenna is now locked in travel position. Turn amplifier power switch “OFF”.

Count the number of turns needed to crank the antenna down to the roof of the unit (normally about 13). Mark the final position of the crank handle on the ceiling or the directional knob for reference. Also mark the number of turns needed. Use the mark and number as a reference whenever you lower the antenna.

! CAUTION

Always align directional handle to “DOWN” position before lowering.

ANTENNA SIGNAL AMPLIFIER

The TV Signal Amplifier switch is located on the left end of the Video Selector System panel as shown. To operate amplifier, turn on power switch.

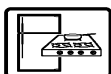

The TV jack plates are mounted in various locations throughout the coach. Some of these wall plates are not readily visible and may be in one of the following locations.

- In front overhead cabinet.
- In the optional entertainment center on the outside of the coach.
- Behind the optional rear bedroom TV.

Checking Amplifier Performance

The TV signals available to an RV are entirely dependent on its location in relation to the transmitter. Signals may vary from strong to no usable signal at all. We recommend that the TV system be checked out in an area known to have good TV reception.

To check the antenna amplifier, raise the antenna, select a TV channel and rotate the antenna for best picture. Then turn off the amplifier power switch. If the antenna amplifier is working properly, the TV picture will now be degraded (snowy). When you turn the switch back on, the picture should again be sharp.

Antenna System Owner's Manual for instructions about aiming the satellite antenna dish. The coach must be level before attempting to aim the antenna dish.

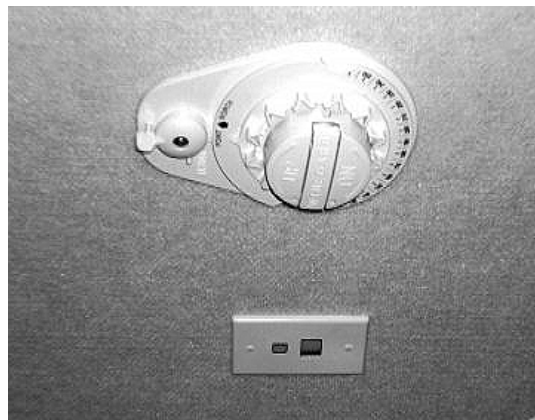

Digital Satellite Dish Control
located on ceiling

We recommend that you **read** the satellite dish manual **thoroughly** to understand the system completely before attempting any setups or adjustments.



VIDEO SELECTOR SYSTEM

The video selector system allows you to switch the antenna, cable TV, satellite TV system or VCR signal to any TV set location in the coach.

This means one person can watch a ball game coming in on the roof antenna on the bedroom TV while another person watches a satellite or cable TV program or a video tape on the VCR on the front TV. Also, two people can watch different programs on the two TV's while taping a third program on the VCR.



DIGITAL SATELLITE TELEVISION SYSTEM - Optional

The Digital Satellite Television System allows you to receive TV programs directly from satellite to your coach. The programs are transmitted in digital format so the quality is equal to laser disc or CD.

See your **Winegard RV Digital Satellite**

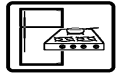

Video Selector

Components

Each component has a set of buttons that lets you select which source you want to get the picture signal from, whether cable TV, roof antenna, digital satellite dish, VCR or whatever equipment you have connected to the AUX input. You will notice the VCR button group has no VCR button. That's because it wouldn't work for the VCR to get a picture signal from itself.

There are three component groups:

- FRONT TV
- DVD Player (in front Video Center)
- VCR (in Video Center)
- TV2 (in Bedroom or Rear of Coach)

Selections (Signal Input):

Each button in a component group lets you select the source you want to draw the picture signal from, such as cable TV, VCR, the roof antenna, or satellite dish antenna. Press the corresponding button to connect to the desired signal source.

- AUX = Press to connect to a video component which you may have installed later, such as a Digital VideoDisc (DVD) player.
- SAT = Press to connect to the Digital Satellite System (dish antenna).
- ANT = Connects to the roof antenna.
- VCR = Connects selected TV to the VCR or DVD.

- CABLE = Connects to a local cable TV system hookup if you have connected one to your coach.

DELUXE AUDIO-VIDEO SURROUND SOUND SYSTEM WITH SONY VCR, VEGA PLASMA TV AND DREAM SYSTEM DVD

Basic Instructions for Watching DVD or VCR

- Connect shoreline or start generator so 110-volt AC is available (or press 'Invert' button on inverter panel)
- Be sure speaker switch on dash is in TV position for surround sound.



- Turn TV On
- Turn DVD player On
- Press TV/VIDEO button (on Remote or TV front panel) and select 'Video 1'. The following screen will appear for DVD viewing.



- Press the WIDE MODE button to select the screen size desired.
- (Default picture aspect is set to 4:3 - Select 16:9 for high definition viewing)

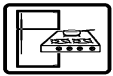

SECTION 8 APPLIANCES & INTERIOR FEATURES

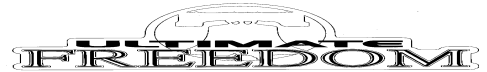

- Press the PICTURE MODE button to select preset modes for various viewing situations.
- Press disc selection button on DVD player to insert DVD into load slot when display show READY. There are 5 disc selector buttons on the top of the player - one for each of the 5 disc 'slots' in the player machine.



- DVD - use Function button to select DVD
- VCR - use Function button to select VIDEO1
- CD - use Function button to select DVD
- Press TV/Video to select VIDEO1
- Be sure the correct buttons are pressed on the Video Selector for input source needed . . . TV ANT when watching broadcast TV, etc.

To Listen to TV through Surround Sound speakers:

- Speaker switch (dash) in TV position
- Turn on VCR and DVD players
- Press DVD 'Function' button and select VIDEO1
- Turn TV speaker volume down to avoid conflict with surround sound
- Control surround sound volume with DVD remote or knob on front of DVD player

NOTE: If you are not getting a good picture, check the Video Selector buttons to be sure the proper input signal source has been selected, whether antenna, cable, satellite, etc.

To Listen to Music CD's through Surround Sound speakers:

- Speaker switch (dash) in TV position
- Turn on DVD player and insert music CD into player
- Press DVD 'Function' button and select CD
- Control surround sound volume with DVD remote or knob on front of DVD player

To Listen to Radio through Surround Sound speakers:

- Speaker switch (dash) in TV position
- Turn on DVD player
- Press DVD 'Function' button and select TUNER
- Use '+' and '-' buttons to select station
- Control surround sound volume with DVD remote or knob on front of DVD player

EXTERIOR ENTERTAINMENT CENTER

The exterior entertainment center contains a stereo radio/compact disc and convenient TV hook-ups for your outside listening or viewing pleasure.



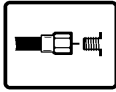
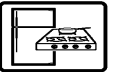

**CABLE TV AND PHONE
HOOK-UPS
(Input)**

The cable television and telephone input connectors are located in the shoreline compartment.

The cable and phone lines can be routed through the hatch in the bottom of the compartment so the door can remain shut while connected.

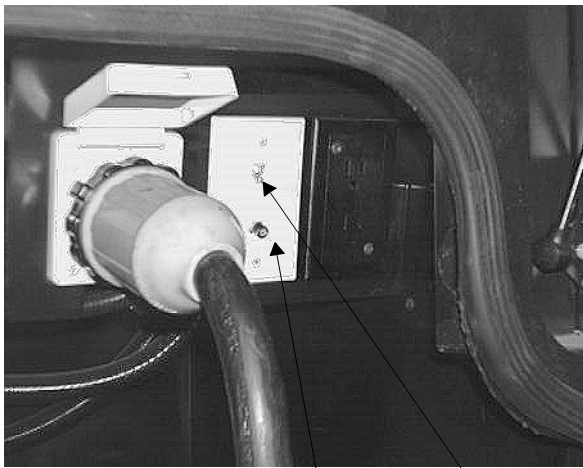

Shoreline Compartment Cable TV Hookup Phone Hookup

Front Phone Jack: On rear facing end of the passenger sidewall armrest just behind the copilot seat.



Rear Phone Jack: In the bedroom, near the radio on the nightstand.



**CENTRAL VACUUM
CLEANER**

The central vacuum cleaner system is located beneath the refrigerator cabinet.

To Use The Vacuum: Plug the hose into the hose outlet. The vacuum cleaner will start automatically. When you remove the hose, the vacuum will stop.

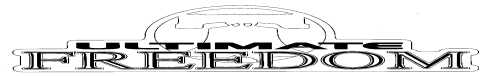
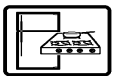

Central Vacuum Cleaner System

To Use Vac Pan: Press the vac pan lever to the right using your foot as shown to open the door and turn on the vacuum unit. Sweep floor debris into the opening. When you release the spring-loaded door it will automatically shut and turn off the vacuum unit.



Storage Compartment Vacuum: For convenient cleaning of exterior storage compartments an additional vacuum hose outlet is located in a middle compartment on the passenger side of the coach.



To Change Filter Bags: Remove the lower drawer from the refrigerator cabinet and pull the cover from the square metal canister.

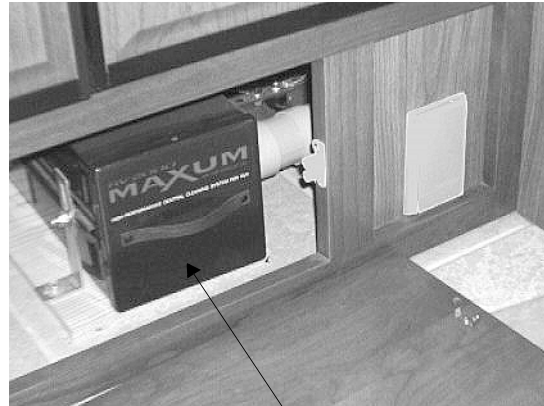

Pull cover off to change bags

If The Vacuum Will Not Start: Check for a tripped circuit breaker. Also be sure that the vacuum unit is plugged into the electrical outlet.

BEDROOM RADIO

The bedroom is equipped with a built-in stereo radio system in the left rear nightstand cabinet. This radio features AM/FM stereo radio with electronic seek/scan turning, auto reverse cassette player/recorder with music search, and a full featured alarm clock mode.



See the Audiovox operator guide on your Owner InfoCase for full operating instructions by the manufacturer.

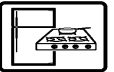

TABLE AND CHAIRS

Your coach may be furnished with one of the following dining tables. The table may be expanded with a leaf when needed.



Dinette Chairs

The dinette chairs are free-standing to allow greater freedom of movement than typical booth style dinettes or pedestal seats. Folding dinette chairs are also provided for additional seating when needed.

Before driving, always stow folding chairs beneath bed or in wardrobe and secure dinette chairs to table leg with hook and loop retainer strap provided.

! WARNING

Be sure all loose items are secured or stored properly while the vehicle is in motion. Possible overlooked items such as canned goods or small appliances on the countertop, cooking pans on the range, or free-standing furniture items can become dangerous projectiles during a sudden stop.

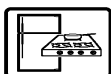

SLEEPING FACILITIES



WARNING

Do not use sleeping facilities while vehicle is moving.

SLEEP NUMBER® BED by Select Comfort™

NOTE: Before Traveling - If you plan to travel with your Sleep Number mattress into mountainous regions, either (1) temporarily disconnect the mattress from the pump hose to allow air to escape or (2) partially deflate the mattress chamber. (Change Sleep Number settings to 20 or lower on both sides before traveling.) Rapid changes in altitude will affect the air pressure inside the mattress. The chamber may be damaged if the pressure becomes too great.



Unlike innerspring mattresses, your Sleep Number bed can be personalized specifically to your ideal comfort level. The dual-chamber mattress gives you the ability to enter a different Sleep Number for each side of the bed. Since no two body types are the same, each sleep partner should personalize their side of the bed with their own Sleep Number.

What is Your Sleep Number?

Your Sleep Number is a setting between zero and 100 that represents the ideal combination of

mattress comfort, firmness, and support for your body, giving you the best night's sleep possible. If you do not have your Sleep Number, this section will take you through the process of finding your Sleep Number and will provide you with additional information about your Sleep Number bed.

Using Your Sleep Number Remote

The buttons of the remote are contoured to be easily distinguished even in the dark if necessary. The 'firmer' button has a slight dome shape and the 'softer' button is slightly dished.



If You Already Know Your Sleep Number

If you know what your Sleep Number is, enter it on the remote by pressing the firmer or softer buttons until your sleep number is displayed. The display screen will blink as the mattress adjusts. Lie still until it stop blinking. There may be some minor "clicking" as the final Sleep Number setting is perfected. Once reached, the remote will display your Sleep Number, then shut itself off.

Finding Your Sleep Number - The Simple Step-by-Step Process:

If you do not already know your Sleep Number or would like to experiment with finding a different one, use the instructions below. It sometimes take several nights of sleeping at different settings to discover your ideal Sleep Number.

STEP 1. Lie on your normal side of the bed in your normal sleep position holding the remote for your side of the bed.

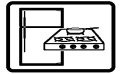

STEP 2. Press the firmer or softer button on the remote to “wake” it up. It will display the current SLEEP NUMBER setting.



STEP 3. Start by setting the Sleep Number to 50 on the remote.

STEP 4: Take time to evaluate your comfort (see diagrams below).

STEP 5: If you like the feel of the mattress at 50, go to Step 6. If you find that this setting is too firm or too soft, change your Sleep Number in increments of 5. Re-evaluate your comfort level after each change. Once you have found a Sleep Number setting where you feel comfortable, log this number into your Sleep Journal.

STEP 6: Try to sleep at this Sleep Number for a minimum of five nights. It will take your body that long to become accustomed to a new sleep surface. After five nights, reevaluate your comfort level and log this into your Sleep Journal. If you need to make adjustments, repeat Steps 5 and 6.

If you would like to experiment further with your Sleep Number setting, just press the Firmer/Softer button in the opposite direction you are adjusting and the Firmness Control System will stop. Then go to the Sleep Number you want.

If after trying four different Sleep Number settings you have not found your ideal Sleep Number, please call 1-800-318-2231 to reach a trained Select Comfort Customer Service Repre-

sentative. They may be able to recommend adjustments, make suggestions, or pinpoint concerns that might be contributing to less than ideal comfort.

Altering Your Sleep Number:

Unlike an innerspring mattress, a Sleep Number bed can be personalized at any time to the changing condition of your body. Some reasons to alter your Sleep Number include:

- strained muscles
- back pain
- weight change
- bad sunburn

In addition to personalizing your bed for a great night’s sleep, you can also alter the mattress firmness when you wake in the morning in order to:

- assist getting out of bed, if needed
- achieve a “fuller” bed appearance

Evaluate Your Comfort Level

Right

- Neck and back are aligned in the same position as when you are upright
- No discomfort at shoulder and hip pressure points.
- You feel the mattress support the small of your back (back sleepers) or the curve of your side (side sleepers).

Wrong

- Body alignment is not straight
- Your pillow* makes your head tilt at an angle to the rest of your body.
- You feel discomfort from pressure in your neck, shoulders, back, hips, or legs.

*Your pillow should help keep your body aligned properly, otherwise, it may interfere with your ability to sleep comfortably.

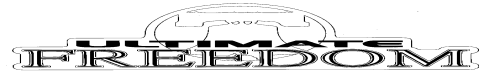
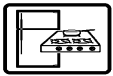

What if I am not comfortable on the Sleep Number I was given when I purchased my Sleep Number Bed by Select Comfort?

Since you probably only spent a few minutes getting your SLEEP NUMBER in the store or through other means, you may find that you need to explore other settings in order to pinpoint your ideal comfort level. Please use the easy-by-step process on this page to set your Sleep Number. If you still do not feel comfortable after going through this process, contact a Select Comfort Customer Service Representative at 1-800-318-2231. Please have your Sleep Journal with you when you call so you can tell your representative what settings you have used.

Why do my numbers fluctuate?

RV users may find that the numbers fluctuate fairly frequently due to changes in temperature within the vehicle and changes in elevations when you travel. Be sure to check your settings when you first lay down on the bed and adjust it as necessary.

It is normal for the numbers on your remote to fluctuate slightly and it is not necessary to make any adjustments. Some reasons for the numbers to fluctuate include: weight differences on the bed, change in sleeping position, heat from an electric blanket, change in room temperature, or weather.

However, if you notice that your bed is getting softer night after night and your Sleep number consistently gets smaller, check to make sure that you have a tight connection between the hose and the air chamber. You should hear it “click” when it connects.

Mattress Care

Cleaning the Mattress Cover:

We recommend spot cleaning your mattress cover with sparkling water (soda) or mild detergent. **DO NOT** dry clean the mattress cover or put it in a washing machine. Also, please do not apply stain-guard, as it may cause yellowing of the fabric.

For allergy sufferers, an added benefit of owning a Sleep Number mattress is the ability to

air it out by unzipping it or cleaning the surface of the air chamber with a vacuum attachment or by applying a bleach solution (use 1 tablespoon bleach to 1 cup water and apply with a rag to surface of air chamber only).

Sheets and Blankets:

If you feel too warm, try using a premium 100% cotton mattress pad, 100% cotton sheets, and an open-weave cotton blanket.



Rest Easy™ Multi-Position Lounge



To Recline: Press the switch on the front or side of the armrest. Press ‘down’ to recline; ‘up’ to return upright.



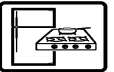

! CAUTION

Do not recline the lounge completely flat unless the footrest trundle section is extended. Do not occupy the lounge when elevating the seatback from the flat position to upright lounge position. If house battery voltage is low, the mechanism may require assistance by lifting the seatback while returning upright from flat bed position.



To Extend Pull-Out Footrest Section: Pull outward on latch beneath lounge face panel and pull out until it locks in the full extended position. Lift footrest up and away from lounge until it is raised into position. The gap between the footrest and seat provides ample room to enter and exit the lounge. If desired, however, the footrest can be unlatched and pushed against the lounge seat. The footrest 'drawer' will latch when pulled out completely and must be unlatched to push back in when stowing the footrest.



To Convert to Bed: Extend footrest section and push together with lounge seat cushion, then press recline button until entire lounge lies flat. Reserve steps to revert to lounge.

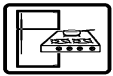

CAUTION

Do not recline the lounge completely flat unless the footrest section is extended.



Heat-Message Controls - hand held

BANQUETTE SOFA (if equipped)



Center back cushion of banquette is also a flip-down beverage tray

WARNING

To avoid injury to young children, do not allow them to operate the lounge, or to play within the lounge or near the operating mechanism.

Dual Heat/Massage Controls

The built-in heat and massage controls are stored in their own pockets on the inside of the armrests. The remotes are tethered on a coiled cord and can be removed for hand-held use as shown.



Heat-Message Controls - stored

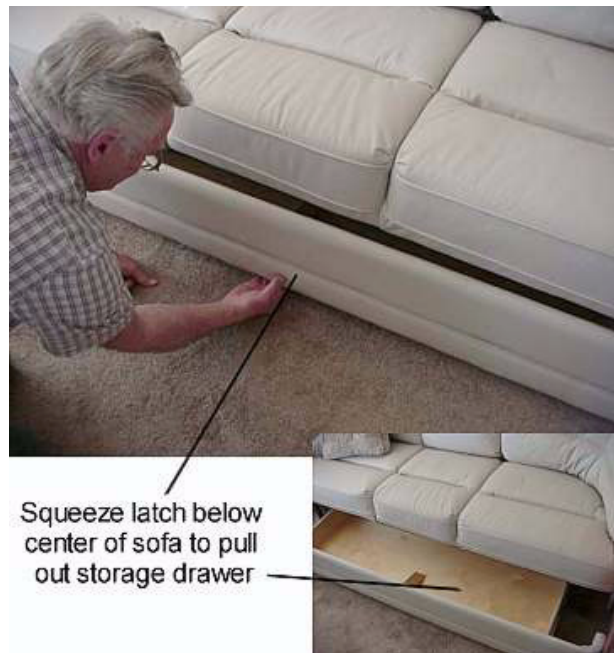

Squeeze latch below center of sofa to pull out storage drawer

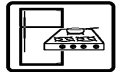

FRESH WATER TOILET

The fresh water toilet in your motor home is very similar to the household type, except that it is designed to use only a small amount of water per flush. It uses a high velocity jet of water, producing a swirl effect, to efficiently cleanse the bowl. And since each flush uses fresh water, no special chemicals are required other than a deodorizing agent, if necessary.

1. To add water to the toilet before using, lift the flush lever until the desired water level is reached. Generally, more water is required only when flushing solids.



2. To flush the toilet, push the lever all the way down until sewage leaves the toilet and bowl is rinsed clean.
3. Release the flush lever. A small amount of water should remain in the bowl.

Please refer to the manufacturer's information supplied with the toilet for further operating and maintenance instructions.

Important "Don'ts"

- Don't use facial tissue or regular toilet tissue in the RV toilet. These will not disintegrate sufficiently and will often cling to the sides of the holding tank. Toilet tissue made specifically for use in RV toilets and holding tanks is available at most RV supply centers.
- Don't dispose of sanitary napkins or other non-dissolving items in the toilet.
- Don't put automotive antifreeze or caustic chemicals, such as laundry bleach or heavy

detergents into the toilet or holding tank.

These products may damage plastic or rubber parts in the system.

Cleaning the Toilet

The toilet should be cleaned regularly for maximum sanitation and operating efficiency. If an odor is apparent from the toilet:

1. Clean the toilet bowl with a mild bathroom cleaner. Do not allow cleaners to set in the bowl for long periods of time to avoid damaging the seals. Do not use caustic or abrasive cleaners in the Thetford toilet since it may damage the plastic surfaces.
2. Dump and rinse holding tank.
3. Add odor control chemical in amount specified after cleaning and every few days during use.
4. Remove the water line from the base of the toilet and clean the screen.
5. If the flush valve becomes stiff after extended use, it may be lubricated with a silicone spray. Turn the water pump off and operate flush pedal to drain water from the toilet bowl. Spray silicone lubricant onto flush valve inside bowl and operate flush pedal a few times to ensure free operation.

See instructions in Section 10 to prepare the toilet for storage in freezing conditions.

POWER ROOF VENT - Bath Area

The power vent in the bathroom ceiling is controlled by a switch on the bathroom wall. The switch raises (open) or lowers (close) the powered dome.

When the dome is raised and it begins to rain outside, the rain sensor feature will close the vent dome automatically to prevent rain from entering the coach.

POWER ROOF VENT - Galley Area

The power roof vent in the galley ceiling has a 3-speed turbine fan and a power dome. The vent is controlled by a thermostat on the galley wall, which will automatically raise the dome and turn the fan on when the temperature

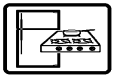

SECTION 8
APPLIANCES & INTERIOR FEATURES



reaches the setting you have chosen. When the air around the thermostat has cooled to below the setting, the dome will automatically lower and the fan will shut off.

The thermostat control can be placed in the OFF position to cancel power to the power dome and vent fan.

Power Ventilator
Thermostat - Galley



Power Vent Thermostat
Bath Area

The fan shroud on the ceiling has a fan power switch that lets you turn the fan off if you want just the vent dome raised with no fan running.

The fan speed switch allows you to adjust the amount of circulation you need at any time.

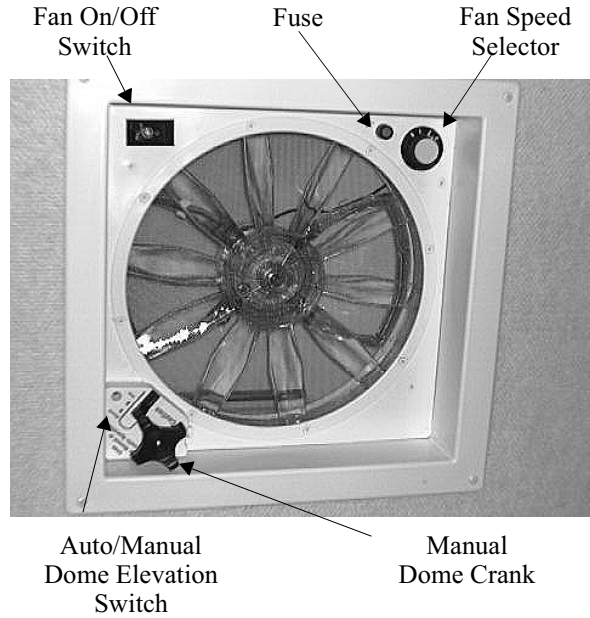

Power Ventilator

CRANK-OUT SIDE WINDOWS

Turn the crank-out knob clockwise to open window; counterclockwise to close. Do not use excessive force on the knob to open or lock into closed position. This could cause permanent damage to the crank mechanism.

When closing the window, crank the window in snugly, then back off 1/4 turn to help avoid glass warping which can result in wind noise.



If the window will not open after three or more full turns of the knob, the glass may be stuck to the sealing gasket. Go to the outside of the coach and gently free the glass with your fingers. A periodic light dusting of talcum powder on the gasket should prevent this from recurring.

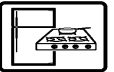

SLIDER WINDOWS

Swing the latch handle straight out from the window. Grasp the sliding window edge frame and slide the window to the side. Be sure the latch is open before trying to slide the window closed.

Vertical slider windows have spring-loaded catches on both sides of the window that pop out to hold the window in its fully raised position. Press the catches outward toward the frames while lowering the window.

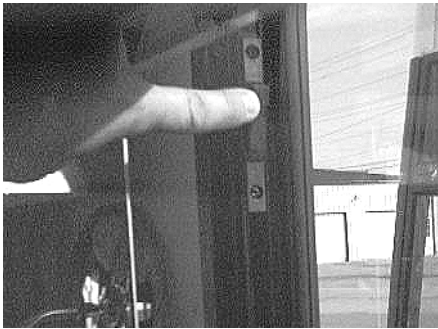

Vertical Window Catches



 CAUTION
Sealants must be inspected every 6 months and resealed if necessary.

ROOF

The roof is made of Thermo-Panel materials like the walls and floor. It will support the weight of an average adult should it become necessary to repair the roof or roof mounted components. It is not recommended, however, that very large or heavy objects be carried on the roof while the vehicle is in motion. (See page 4-2 for roof loading specifications.) Always have damage to the roof area repaired immediately. Damaged or detached sealant around the vents, air conditioner, body-to-roof seams, etc., should also receive immediate attention. Delaying these repairs may allow water leakage and result in damage to interior ceiling and body panels, upholstery, etc.

UNDERBODY

Buildup of mud and dirt under the body can cause damaging rust on steel parts and can add needless weight to the vehicle. This, in effect, reduces the amount of cargo you can carry and remain with GVWR and GAWR limits.

Corrosive materials, such as those used for ice and snow removal and dust control, also accumulate on the underside of a vehicle. These materials should be removed by flushing the underbody regularly with water, especially areas where mud and other foreign materials collect.

EXTERIOR

The exterior surface of your motor home has an automotive finish. Frequent washing and thorough cleaning is recommended to prevent damage to the vehicle finish after exposure to damaging salts, calcium chloride, road tar, tree sap, insects and other foreign material. Never wash the vehicle in direct sunlight, while the vehicle surface is hot, or using hot water.

Do not use strong soaps or detergents for washing the motor home. Always use a mild soap in warm water, a commercially prepared product for cleaning automotive finishes or your local car wash. Be careful when using pressure-type washers to avoid loosening exterior decals or sealants, etc.

NOTE: Avoid aiming water flow from a hose or spray from high pressure washing equipment into any appliance intake or exhaust vents, which could cause damage or difficulty in operating appliances.

After washing the motor home, carefully inspect caulking around window frames and vents and any other joints that may have separated. Re-caulking, if necessary, is quite simple. Appropriate compounds are sold at Winnebago and Itasca dealers, and the materials are quickly and easily applied. Also, inspect weather seals around door, etc., and if necessary have a dealer replace them immediately.

 CAUTION
Never use a strong solvent such as lacquer thinner, or harsh abrasives on painted surfaces.

Care of your Gelcoat Fiberglass Finish

You can keep the gelcoated fiberglass exterior finish of your coach looking good for years to come with a minimum of care. The smooth automotive finish is as easy to care for as your car's - just wash regularly and wax as needed.

Washing

Regular washing with a soft brush, mild soapy solution and water will keep it clean - and keep black streaks from forming.

Waxing

A high-grade automotive wax used as needed will restore Performance Plus' original luster and



color. It is best to wax at least every spring and fall, more often if your RV is frequently exposed to extreme sun, smog, soot or other environmental pollutants.

Stains and Discolorations

Regular cleaning and waxing will help prevent most discolorations and stains, however, please be aware that using caustic, highly alkaline cleaners or any cleaner with ammonia may actually darken your RV's exterior. If stains or discolorations do appear, they can be removed by gently wet-sanding the discolored area with a fine grit sandpaper and then using an electric or pneumatic buffer and a liberal amount of rubbing compound. Finishing with an automotive wax will restore the gelcoat's original luster.

NOTE: Your Winnebago Industries RV dealer is equipped and trained to handle this type of work. We advise you see him before attempting this yourself.

Scratches

Although the gelcoat exterior is very scratch resistant, scratches may occur occasionally. Those that haven't penetrated too deeply can usually be rubbed out with an automotive polishing compound applied with a power buffer or by hand. Not all scratches disappear completely, but they will be less noticeable. After using the polishing compound, you should then wax your RV to seal the surface. This will enhance the gelcoat's gloss and color and prevent stains. It is best to let your Winnebago Industries RV dealer evaluate the situation before using an automotive polishing compound.

If Accidents Happen, Repairs Are Easy

If a mishap causes a gouge or chip in your RV's gelcoat exterior, it can be repaired nearly anywhere, whether you are at home or on the road. Most Winnebago Industries RV dealerships have repair shops staffed with employees skilled in repairing gelcoat, or they can refer you to a body shop equipped to handle these repairs. Either way, your RV should come out looking like new.

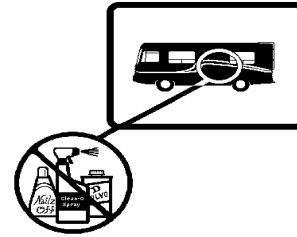

Care of Stripes and Decals

The pressure-sensitive decals on your coach require very little maintenance. They should be treated like any painted surface on your vehicle. Here are a few helpful hints on caring for decals:

- Wash decals with plain soap and water or any retail car wash soap. Always rinse thoroughly.
- Keep high-pressure wash nozzles at least 1 1/2 feet from edge of decals. High pressure water spray may cause edge lifting of decals.
- Test any cleaning solution on a small section of decal before using.
- Do Not use any aromatic solvents such as acetone, MEK, toluene, xylene, etc., on decals. Any solvent including alcohol may soften or smear colors.
- Do Not use lacquer thinner or paint on decals. Do Not overcoat decals with clear paint.
- Do Not let gasoline or other fuels drip and stay on decals for any length of time. Rinse immediately.

COMPARTMENT DOORS

Apply powdered graphite lubricant to compartment door latches periodically as necessary to keep latches operating smoothly.

If rubber door seals should become sticky, making the door hard to open, apply a rubber protectant such as 303™, Armor-All™, Son-of-a-Gun™, etc.

UPHOLSTERY, CARPETING AND DRAPERIES

We recommend a weekly routine of vacuuming all fabrics and carpet throughout the motor

home to prevent an accumulation of dirt which can detract from the appearance and shorten the life of carpet and fabrics.

Carpets

See the carpet manufacturer's Carpet Care Guide in your Owners InfoCase. It includes detailed information on cleaning soils and removing stains from the fine carpet in your coach.

Upholstery

Some fabrics used in this motor home may contain fire retardant and lightfastness additives which can be damaged by use of improper cleaning products. Some water-based household cleaning products are not formulated for use on fabrics and may cause excessive shrinkage or fading. Always test any cleaning product on a hidden area of fabric before using on visible areas. For best results, fabric cleaning should be referred to a professional carpet and upholstery cleaner.

NOTE: To minimize fading of upholstery, carpets and other interior fabrics caused by excessive sunlight, the drapes, blinds or shades should be closed when the motor home is parked for an extended period of time.



WARNING

When cleaning upholstery and fabric, do not use lacquer thinner, nail polish remover, laundry soaps, or bleach. Never use carbon tetrachloride, gasoline, or naphtha for any cleaning purpose. These materials may cause damage to the material being cleaned and most are highly flammable.

Spots and Stains

Spots or stains should be treated as soon as possible before they "set in" to avoid permanent damage. Always start from the outside of a spot

or stain and work inward to avoid spreading it. Use a clean cloth or sponge and turn frequently to an unused area of the cloth or sponge as you clean.

Some stains or soils, such as lipstick, ink, grease or mustard, are extremely difficult or impossible to remove completely and should receive immediate attention. Consult a professional carpet and upholstery cleaner for assistance.

Leather Upholstery - Driver/Co-Pilot Seats & Sofa - (Optional)

The optional leather seats are made of top quality cattle hide soft leather.

- We recommend using a mild soap and water applied gently to the soiled areas. Buff dry immediately with a soft cloth to avoid water spotting. Avoid harsh and excessive rubbing while cleaning. Soft leather needs delicate care.
- Never use harmful substances (e.g. stain removers, solvents, saddle soap, shoe polish or other unsuitable fluids) on soft leather. Cleaning and touch-up kits specifically formulated for leather upholstery are available from most fine furniture dealers.

Vinyl Fabrics

Vinyl should be cleaned with a soft, damp cloth, and a mild detergent only. Do not use solvents. Solvents may damage the surface of the vinyl.

Draperies, Curtains and Bedspreads

These items may be woven from a variety of fabrics. We recommend that these be professionally dry cleaned only. A five percent shrinkage may occur when you have these items dry cleaned.

Care of Ceiling Fabric

While using your coach, your ceiling fabric may become soiled and require spot cleaning from time-to-time. The following information is provided as a guideline for care and cleaning of ceiling fabrics used in your coach. These materi-



SECTION 9
CARE & MAINTENANCE



als are made from synthetic fibers, so they clean very well with virtually no damage to the color or fabric itself.

Most commercially available carpet and upholstery cleaners will do an excellent job removing stains. From time to time, additional cleaning methods may need to be used to remove stubborn or difficult stains.

General

As with any stain or contamination, the quick response is the best, especially when done in conjunction with the proper cleaner from the type of stain. Important: Make sure you have selected the

right cleaning agent from the list below from you begin the cleaning process.

NOTE: In many cases listed above, repeated steps may be required to fully extract the contaminant from the material. Use solvent-type cleaners in a well ventilated area.

NOTE: Always check to see that the cleaner will not cause damage to material or fabric by testing on a small area out of sight.

Type of Stain	Cleaning Agent	How to Remove
Mustard	Dry-Clean Solvent	Scrub-Soak-Blot Dry
Ketchup*	High-Strength Detergent	Scrub-Rinse-Blot Dry
Coffee*	High-Strength Detergent	Scrub-Rinse-Blot Dry
Chocolate*	Detergent	Scrub-Rinse-Blot Dry
Tea	High-Strength Detergent	Scrub-Rinse-Blot Dry
Chewing Gum	Dry-Clean Solvent	Scrub-Soak-Blot Dry
Oil	High Strength Detergent	Scrub-Soak-Blot Dry
Grease	High-Strength Detergent/ Degreaser	Scrub-Soak-Blot Dry
Tar/Asphalt	K-1 Kerosene/Thinner	Scrub-Soak-Blot Dry
Wax	Detergent	Hot Iron-On Detergent-Soaked Towel or Cloth
Rust	Rust Remover	Scrub-Rinse-Blot Dry
Dirt*	Detergent	Scrub-Rinse-Blot Dry
Lipstick	Dry-Clean Solvent	Soak-Blot Dry
Nail Polish	Dry-Clean Solvent	Soak-Blot Dry
Shoe Polish	Dry-Clean Solvent	Soak-Blot Dry
Crayon	High-Strength Detergent	Scrub-Rinse-Blot Dry
Marker (Indelible)	Detergent	Scrub-Rinse-Blot Dry
Ink (Ballpoint Pen)	Dry-Clean Solvent	Soak-Blot Dry
Pencil Lead (Graphite)	Detergent	Scrub-Rinse-Blot Dry
Vomit*	High-Strength Detergent	Scrub-Rinse-Blot Dry-Deodorize w/Vinegar
Urine*	High-Strength Detergent	Scrub-Rinse-Blot Dry-Deodorize w/Vinegar
Blood*	High-Strength Detergent	Scrub-Rinse-Blot Dry
Excrement*	High-Strength Detergent	Scrub-Rinse-Blot Dry-Deodorize w/Vinegar



NOTE: In many cases listed above, repeated steps may be required to fully extract contaminant from material. Items listed above with () may also be removed through steam extraction method by a professional cleaner or service.*

NOTE: Always check to see that the cleaner used will not cause damage to the material or fabric by testing on an area out of sight.

Water Stains

Water stains are the most common problem. The first thing to remember is that it's not the water itself that is making the stain, it is pigments the water extracts from the ceiling materials it travels through that causes the stain.

Mix 1/4 cup of white laundry detergent with a bucket of warm water. Working with a clean sponge or white cloth, start from the outside of the stain and work your way to the center. This method will keep the stain from spreading. Do not over saturate as this may cause delamination. No need to scrub, simply rub lightly or dab the stain.

You may have to repeat this procedure more than once to achieve desired results. Finish up with clean water, using the same method, and blot dry. REMEMBER, this is polypropylene, basic plastic, so do not be afraid to clean it.

Steam cleaning is also an option. Again, take care not to over saturate.

IMPORTANT: The recommendations made above are done in good faith and are based on a history of actual experiences and laboratory evaluations. Foss Manufacturing Company, Inc. and/or its designed distributor does not warrant, either expressed or implied, the effectiveness of the cleaning agents listed and the process for cleaning described above.

CABINETRY

Your cabinets are made of high quality hardwoods. Clean and beautify using a soft cloth and a good quality lemon oil wood finish cleaning product.

NOTE: Cabinetry and furniture items throughout this motor home are constructed either partially or completely of real hardwoods. Because of natural variations in woodgrain density, slight differences in stain hue may exist between one item and another. This is the distinctive character and beauty of real wood.

Decorative Cabinet Mirrors and Windows

Use a good quality glass cleaner or mild soap and water solution. It is best to use a spray bottle to apply a light mist rather than saturating the surface. WIPE DRY IMMEDIATELY. DO NOT ALLOW GLASS TO REMAIN WETTED FOR LONGER THAN A FEW SECONDS. Prolonged moisture can cause the applique coating to lift from the surface of the glass.

Do not use sharp objects to scrape debris such as fly specks etc. Sharp objects can chip or lift the applique coating.

COUNTERTOP SURFACES

The countertop and work surfaces are made of beautiful and durable solid surface material.

- Wipe clean with a sponge and soapy water or ammonia-based cleaner.
- Stubborn stains may be removed using a 3M Scotch-Brite™ or equivalent type scouring pad.
- Towel dry to eliminate water spotting.
- Disinfect by wiping with 50/50 mixture of water and household bleach. Rinse with clean water.
- See the countertop manufacturer's Care & Maintenance booklet in your operations manual binder for further information.

VINYL WALLBOARD

Decorative vinyl covered wallboards may be cleaned with a mild soap and water solution. Do not use solvents or abrasive cleaning products.



RANGE AND REFRIGERATOR

For care and appearance maintenance of the range and refrigerator, refer to the operation and maintenance manual for each of the individual appliances included in your Owners InfoCase.



BATHROOM

The tub and shower walls in the bathroom should be cleaned with a mild soap and water solution, or (to obtain maximum luster) use a good quality wax cleaner. Do not use an abrasive cleaner on the shower walls and tub. If the shower has a glass door, it is extremely important that abrasives not be used. Solvents and aromatic spirits that contain a petroleum base or additive should also not be used. These products can cause a reaction with the glass that results in visible deterioration marks. Use only a good quality glass cleaner or mild detergent and water solution with a soft cloth to clean glass surfaces.

The bathroom lavatory is made of solid surface material and should be cleaned with a mild soap and water solution. Abrasive cleaners or harsh detergents should not be used. See “Tables and Countertop Surfaces” for more information.

For instructions on the care of your fresh water toilet, refer to the information in your Owners InfoCase.



DOORS AND WINDOWS

Windows may be periodically cleaned with a good quality glass cleaner or mild soap solution using a soft cloth. Use care when removing ice or frost from the windows. Always use a plastic ice scraper, never one made of metal. Use care when removing ice from the mirrors to protect the reflective surfaces.

Door locks and hinges should be lubricated periodically with powdered graphite to ensure

trouble-free operation and to protect against freeze-up.

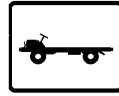

**VEHICLE
MAINTENANCE**

(See also Safety Precautions, Section 1 of this manual).



**CHASSIS SERVICE &
MAINTENANCE**

Consult the appropriate sections in your chassis operating guide for specific information regarding operating safety, service recommendations and maintenance schedules for the chassis section of your motor home.

REAR ENGINE GRILLE

The diesel engine is located behind the grille at the back of the vehicle.

With the service panel open, you can access the following service points:

- Engine Oil Dipstick
- Transmission Dipstick/Fill Tube
- Engine Oil Fill Cap
- Hydraulic Fluid Reservoir
- Engine Coolant Tank
- Air Filter Restriction Indicator
- Fuel Filter

Unlock the service panel and swing it upward.



Engine Oil Dipstick

Transmission Fluid Dipstick

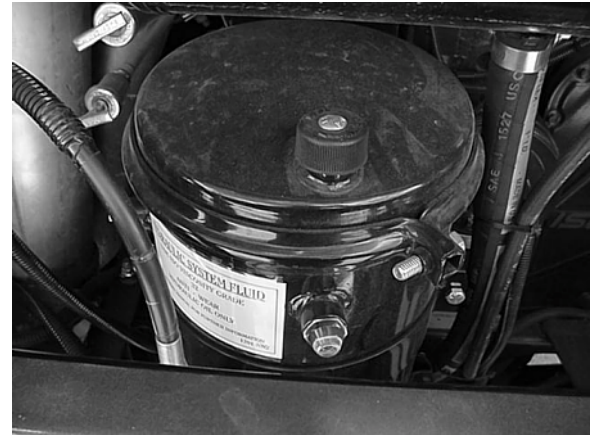

Hydraulic Fluid Tank



Engine Oil Filler

FUEL FILTER/WATER SEPARATOR

Diesel fuel often contains small quantities of water which can damage the engine if not filtered out. The fuel filter traps this water and prevents it from reaching the engine. The harmful water deposits must be drained from the separator chamber during normal periodic service and maintenance to keep the fuel filtration system working effectively.



Air Filter Indicator

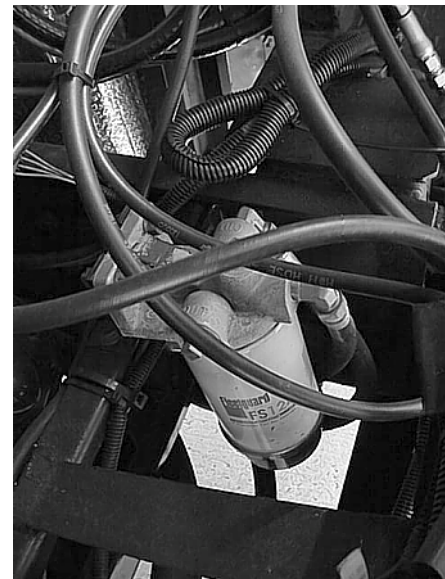

Diesel Fuel Filter

Place an appropriate container beneath the outlet and screw the water release valve open several turns. Drain any water deposits from the



canister until clean diesel fuel flows from the valve. Close valve by hand. Do not over tighten.

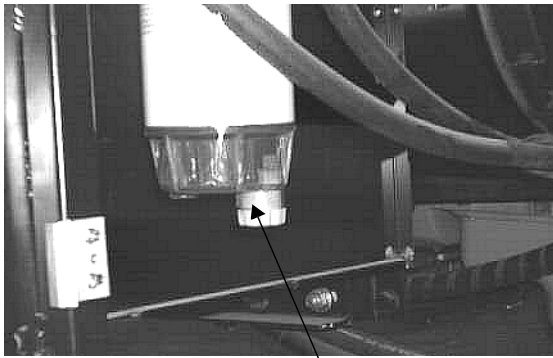

Fuel/Water Drain Valve

Dispose of the drained liquid in an environmentally responsible manner, such as taking to a waste oil disposal center.

ENGINE TOP COVER

The engine top cover is located beneath the rear bed. This cover is only removed for replacement of engine parts or if a complete view of the engine is needed for inspection. To do this, remove the mattress from the bed and lift the hinged bed board upward. Support the bed board with a suitable prop rod while accessing engine.

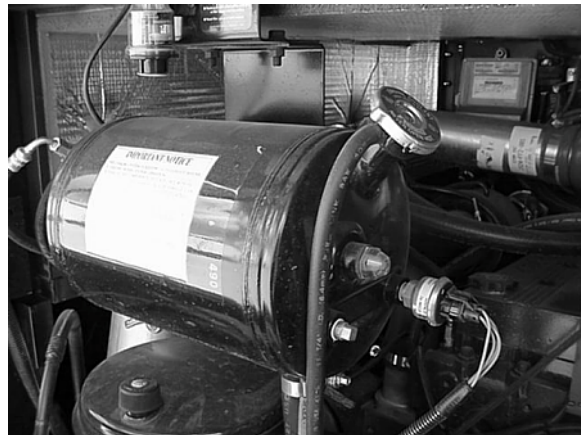

Engine Coolant Tank

CAUTION

When refilling the coolant system, be sure to allow for additional coolant capacity of the automotive heater and its supply and return hoses.



ENGINE COOLING SYSTEM

Refer to your Spartan chassis operating manual and Cummins engine manual for information and precautions on filling, servicing and checking the fluid level.



TIRES

Low air pressure results in tire overloading and abnormal wear and also affects handling and fuel economy. Obtain proper inflation pressures from your chassis operating guide or tire manufacturer.

See the Vehicle Certification Label affixed to the wall near the driver's seat for tire information.

WARNING

Make sure all replacement tires are of the same size and ply rating as those installed as original equipment.



SUSPENSION ALIGNMENT AND TIRE BALANCE

The front suspension and steering system of this vehicle was factory aligned using highly accurate equipment prior to delivery to the dealership. However, we recommend that alignment be checked and adjusted, if necessary, after you have fully loaded the motor home according to your personal needs. Thereafter, the alignment should be periodically inspected to help prevent uneven tire wear.

Any excessive or abnormal tire wear may indicate worn or misaligned suspension or steering, unbalanced tire or other tire/suspension problem.

Alignment can be affected by worn steering/suspension parts or by incidents which happen during driving, such as hitting a curb, pothole or railroad track, etc. Improper alignment can cause tires to roll at an angle and wear unevenly. It may also cause the vehicle to “pull” to the right or left. Have your dealer inspect your vehicle’s suspension and steering components periodically for misalignment or wear.

Out-of-balance tires will not roll smoothly and can lead to annoying vibrations and uneven tread wear such as cupping and flat spots. Tires may need to be balanced if uneven wear is detected or if ride comfort decreases noticeably.

See your chassis operating guide for further information.

Loading the Vehicle

NOTE: Your motor home’s load capacity is designated by weight, not by volume, so you cannot necessarily use all available space when loading your motor home. See page 4-1 for more information.



WINDSHIELD WASHERS AND WIPERS

See your chassis operating guide for recom-

mendations, precautions and replacement information on washers and wipers.

The windshield washer fluid reservoir is located in the front of the coach at the right hand side behind the ‘hood’ panel. A long-necked funnel may be required for filling. We recommend using commercially available premixed solutions for best results. Do not use water in freezing temperatures because the washer pump could become damaged.



Windshield Washer Reservoir behind front “hood” panel.



LIGHTS

All exterior lights should be checked for proper operation each time the vehicle is prepared for a trip. Any bulbs which fail to light should be checked and replaced, when necessary, with a new bulb of the same size. A failure of more than one light, such as both taillights not operating, may indicate a burned out fuse. Check fuse and replace with one of the same rating when necessary. If a fuse is not the cause of the problem, the wiring system should be checked immediately by an authorized service center.

The headlight circuit is protected by an auto reset circuit breaker built into the headlight switch. An overload on the breaker will cause the lights to flicker on and off. Headlight wiring should be checked immediately anytime this con-



dition is apparent. Refer to your chassis operating guide for further information.

AUTOMOTIVE 12-VOLT FUSES AND CIRCUIT BREAKERS

The automotive fuses and breaker are conveniently located on the automotive fuse/breaker panel in the driver side front cargo compartment as shown below.

The circuit breakers will pop outward if they are tripped. Simply push in to reset.

Always replace plug-in type fuses with those of the same amperage size.

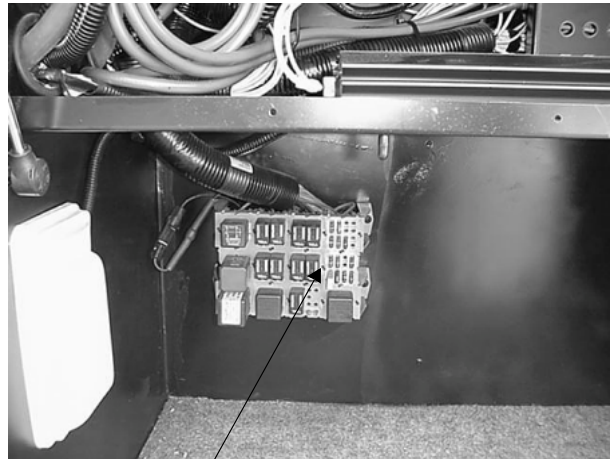

Automotive 12-Volt Fuse Panel



Automotive 12-Volt Breaker Panel

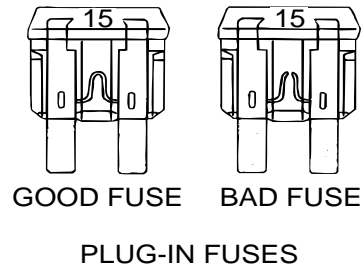



PREPARING VEHICLE FOR STORAGE

Properly preparing your vehicle for storage will lessen the possibility of damage to your vehicle. Prepare the motor home for vacancy just as you would if you were leaving your house for an extended period:

- Remove all perishables from cabinets and refrigerator
- Prop refrigerator door open.
- Turn off LP gas tank.
- Drain water heater, water tank and holding tank.
- Close shades to protect upholstery from sunlight

When storing your vehicle through the winter, or in cold climates, extra preparations need to be made to protect systems that can be damaged by freezing temperatures.



Cold Weather Storage Procedure (Winterizing)

1. Clean and dump holding tanks by following steps A, B, and C
 - A. Add water to the sewage holding tank by holding the toilet flush lever open with the water pump running. Add water to the waste water holding tanks by opening the kitchen, shower and lavatory faucets. Tanks should be about 1/4 to 1/3 full to rinse properly. Driving to a disposal site will normally loosen and rinse any waste material from the sides of the tank.
 - B. Completely drain the sewage and waste water holding tanks at an approved waste disposal site. Drain the sewage tank first so the following waste water can rinse any waste solids from the dump outlet and sewer hose.
 - C. Close dump valves and refit the dust cap onto the drain outlet.

2. Level the motor home and drain the entire plumbing system as described in the following steps.
3. Then turn on Wash Station Shower Head and lay shower head on ground to drain any water left in shower line. Also place the tip of your finger into the city water inlet and gently press the backflow valve "button" in the center of the inlet to drain any water left in the stub line.

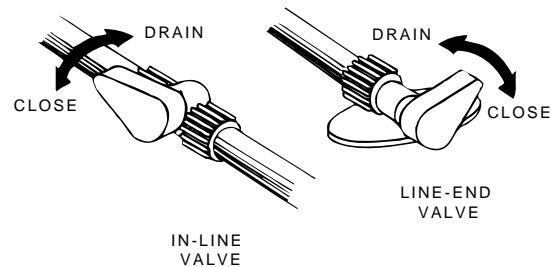

4. Remove and discard the water filter cartridge
 - Raise the valve handle on the filter base.
 - Twist the filter cartridge counterclockwise about 90° and pull it down and out of the filter base.



- Place a container beneath the filter base and lower the valve handle to drain any water remaining in the filter lines.



SECTION 10
STORING YOUR MOTOR HOME



NOTE: If your coach is equipped with the refrigerator ice maker option, the ice maker water lines must also be drained. See "Winterizing the Ice Maker" on page 8-4.



Water Filter Assembly -
Below Galley Sink

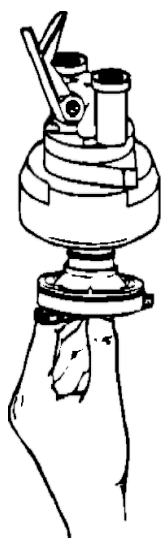

5. Install the antifreeze diverter plug -
 - Raise the valve handle on the filter base.
 - Hold the diverter by the support bar as shown and guide it up into the filter base.
 - Push the diverter up into the head as far as possible and turn it clockwise approximately 90° until it stops.
 - Lower valve handle to lock the diverter plug in place.

NOTE: Before using again the following spring:

- Flush out the system with the diverter in place.
- After the system has been thoroughly flushed, remove the diverter and store for future use. The diverter plug is intended for winterization only.
- Install a new water filter cartridge.
- If your coach is equipped with the refrigerator ice maker option, the ice maker water lines must also be drained. See "Winterizing the Ice Maker" on page 8-4.

6. Turn the Water Pump switch ON to allow it to operate until you are done draining all faucets and toilet.
7. Open all faucets and shower head valves, including exterior shower.
8. Operate the toilet flush lever and hold until water stops flowing in the toilet. Then turn water pump switch OFF.
9. After water has stopped draining at all faucets and drain valves, connect a "blow-out" plug to the city water connection on the coach. Then use a hand pump or air compressor regulated to 30 psi or less to force air through the system. (A "blow-out" plug can be purchased at any Winnebago or Itasca dealer. P/N 701705-01-000.)

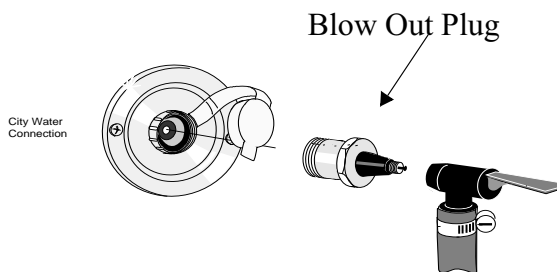

! CAUTION

Limit air pressure to 30 psi to avoid damage to pump or water lines.



NOTE: DO NOT burst air into the system. This can damage the water pump. It is better to let air in slowly.

10. Let air flow for five minutes until water is completely drained out of faucets and drain valves. Then close faucets one at a time.
11. Operate and hold toilet flush lever until water is completely drained from toilet.



12. Now turn air pressure off and disconnect water purge adapters. Recap the city water connection to avoid contamination by dirt or insects.
13. Close all drain valves and faucets to avoid contamination by dirt or insects. Reinstall water heater drain plug and close P-T relief valve.
14. Pour about one cup of non-toxic RV antifreeze into the kitchen sink drain, bathroom sink drain and shower drain. This prevents any holding tank odors from entering the coach during storage.

! WARNING

NEVER use automotive antifreeze/coolant in your RV water system. Auto antifreeze contains ethylene glycol which, if ingested, can cause blindness and can be fatal.

It is not necessary to add antifreeze to the toilet since the flush valve will be closed.

Do not add automotive antifreeze or caustic chemicals such as bleach or laundry detergents into the toilet bowl or holding tanks. Although these products may have a deodorizing effect, they may damage plastic and rubber parts in the system.

NOTE: As an alternative to totally draining the plumbing system, you may winterize tanks and lines by pumping non-toxic RV antifreeze through the system. This product is available from your dealer and from most RV supply stores. Follow directions on the container to determine the correct amount to use for your coach.

See "RV ANTIFREEZE WATER LINE WINTERIZATION SYSTEMS" at the end of this section for instructions.

! CAUTION

Leave by-pass valve handle in NORMAL FLOW position if draining water and blowing out water lines. Place in BYPASS position ONLY when using antifreeze solution in water lines.

15. Place a bucket beneath the sewage drain valve outlet and re-drain the sewage and waste holding tanks of any clean water that entered during "blow-out" procedure.

Close dump valves to prevent valve shafts from rusting and to prevent entry by rodents and insects. Refit the dust cap onto the drain outlet.

Your drainage and fresh water systems are now totally winterized.

16. Turn off the LP gas tank.
17. Turn the THERMOSTAT switch on the bottom of the thermostat to OFF.
18. Be sure the Hydronic Heater system has been shut down. Check both the interior



remote panel On/Off switch and the main power switch on the heater unit control panel in the exterior compartment.

CAUTION

NEVER disconnect coach batteries or fuses to the Hydronic Heater system unless the system has first been shut down using the remote and main service switches. If the battery power source is disconnected while the system is running it will cause serious damage to the Heater, which will not be covered under warranty.

19. Remove all foods and items that may cause odors from cabinets and refrigerator.
20. Clean and defrost the refrigerator. Prop the door open slightly to allow any odors to dissipate. Place an open box of baking soda inside the refrigerator to help absorb odors.



Slide prop 'bolt' outward to prop door open for ventilation during storage periods.

21. Have the vehicle chassis completely serviced and lubricated. Be sure radiator antifreeze protection level is sufficient for the lowest anticipated temperatures.
22. Wash and wax the coach.
23. Inspect all seams and seals around doors, windows, vents, and any other joints. Replace or repair any that are damaged. Sealing materials and compounds can be purchased from your dealer. Badly damaged weather seals may need to be replaced by your dealer.

24. Close all windows and roof vents. Protect all appliance vent openings from contamination by animals or insects (e.g. bird nests, wasp nests, etc.)
25. Lubricate all door hinges and locks.
26. Clean the interior of the coach. Dirt and stains are more easily removed when fresh.
27. **Fully charge the batteries. Batteries must have at least 80% charge to survive freezing temperatures and long period of non-use.** We recommend that you connect a battery charger or plug in the shoreline once a month during long-term storage periods to maintain battery charge and to avoid sulfating. If connecting a charger directly to batteries, turn the Aux. Battery switch off to avoid electrical arcing when attaching and detaching charger clamps.
28. After charging batteries, turn the Aux. Battery Switch off to disconnect the batteries and avoid parasitic drain.

NOTE: We do not recommend leaving the shoreline plugged in continuously during storage periods because the batteries can lose electrolytic fluids and become damaged from continuous charging without periodic use. We recommend following regular battery inspection and maintenance, especially in cold weather. See "Battery Maintenance" on page 6-10 this section.

RV ANTIFREEZE WATER LINE WINTERIZATION SYSTEMS

Manual Winterization Valve - Standard

Your coach is equipped with a manually operated water line winterization system for your convenience in winterizing fresh water lines.

The system features a diverter valve and draw tube in-line between the tank and water pump, and uses the water pump to draw non-toxic RV water system antifreeze into the water lines. This feature is located near the water pump and drain valves.

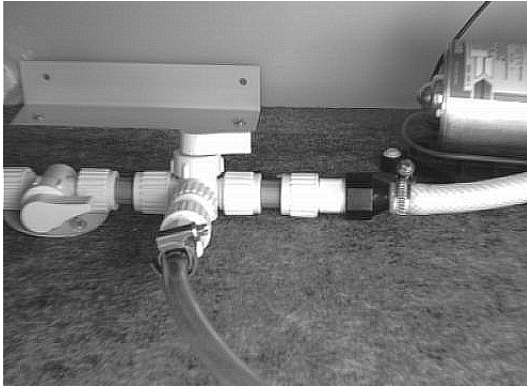

To Fill Lines with RV Water Line Antifreeze:

- Turn water heater by-pass valve to by-pass position.
- Remove and save the protective cap from the end of the siphon tube.

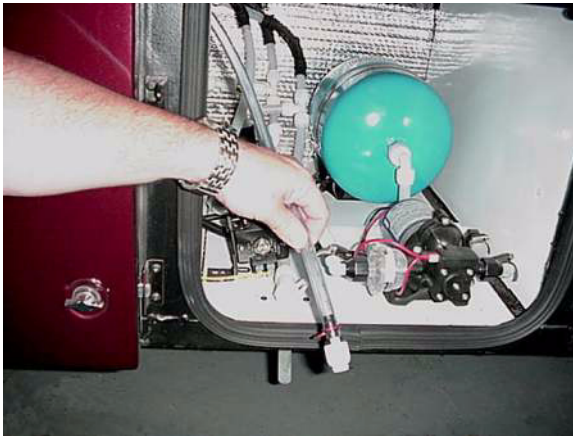

Winterizing System Siphon Tube

- Insert the end of the siphon tube into a container of RV antifreeze solution. We recommend using a clean bucket or container that can hold at least 3 gallons of RV antifreeze to avoid frequent refills during the process.
- Turn the diverter valve handle so that it points toward the siphon tube.
- Turn a water pump switch on.
- Open each cold water faucet handle in the coach one at a time until antifreeze solution just begins to flow from the faucet, then close.

When Done Adding RV Antifreeze:

- Turn water pump switch off.
- Turn the diverter valve handle so it points toward the water line to the pump as shown in the photo. This will stop the flow from the siphon tube and revert the tank line flow to the pump.
- Replace the protective cap onto the end of the siphon tube to keep out insects and debris when not in use.

Washer/Dryer Winterizing

1. Turn off the hot and cold water faucets to the machine and disconnect the hoses. (Tie or wire up the hoses to the faucets to keep them from dropping down behind the machine.)
2. Set the machine to fill on regular cycle and WARM wash.
3. Turn the machine On for a few minutes so it can take in any water left in the hoses. (Life the hoses at this time to be sure no water is trapped in low spots of the hose.)
4. Turn the machine off.
5. Advance the wash time to SPIN cycle and turn the machine On to pump out as much water as possible.
6. Turn the machine Off again.
7. Place a bath towel or shallow container beneath the drain/lint filter door on the lower front of the machine to catch water. Then remove the filter to drain any water left in the bottom of the machine.
8. Reinstall the filter correctly to assure that it does not leak water.
9. Optional - If you wish to add RV antifreeze to ensure safety of the washer pump, add about a gallon of non-toxic RV water system antifreeze to the washer drum and rerun the SPIN cycle to fill the pump and lower cavities with the solution.
10. Turn the machine off.

Washer/dryer winterizing is now complete.

NOTE: Remember to reconnect the washer supply hoses when placing the washing machine back into service. Then run the machine through the fill/spin cycle (steps



2-6 above) to remove and rinse the RV antifreeze from the machine.

Dishwashing Winterizing

1. Empty all dishes from the dishwasher.
2. Follow coach winterization instructions for using the winterization valve to draw RV water system antifreeze into the water system so antifreeze can enter the dishwasher.
3. Set the dishwasher controls to the start of the Rinse cycle and run briefly until antifreeze can be seen inside the dishwasher.
4. Set the controls to the end of the Rinse cycle to pump the liquid out of the dishwasher to make sure the lines and pump contain antifreeze.
5. Turn dishwasher controls to Off.
6. Pour about a quart of RV water system antifreeze directly into the dishwasher to ensure protection of pump and drain lines.
7. Dishwasher is now winterized.

To Winterize the Fresh Water Hose Reel:

The recommended method to winterize the hose reel is to use compressed air (limited to 30 psi or less) to blow out the hose and line. Open a faucet inside the coach, then insert an air nozzle into the end of the hose and force out the remaining water from the hose and reel line. A one-way check valve will keep water in the coach water lines from re-entering the hose if you still wish to use the water system from the fresh water tank without city water hookup.



REMOVAL FROM STORAGE

1. Completely air out the motor home.
2. Have the entire LP gas system checked for leaks.
3. Check window operation.
4. Check cabinet and door hinges. Lubricate with penetrating oil, if necessary.
5. Close all faucets and drain valves that are open. If necessary, reconnect toilet water line and close flush valve.

6. Add a few gallons of water to the fresh water tank and check for leaks especially at junctions. Also make sure all hangers and supports are securely in place. Sanitize the water system as outlined under "Disinfecting the Fresh Water System" in Section 7.
7. Check operation of all faucets to be sure faucet washers have not hardened during storage.
8. Check sealing valve in the toilet for proper operation and lubricate with silicone spray.
9. Add water to the holding tank using the toilet flush pedal. Check to be sure dump valve seals tightly.
10. Check around all appliances for obstructions and ensure that all vent openings are clear.
11. Start refrigerator and check for proper cooling.
12. Clean paneling and counter surfaces and apply a thin coat of wax.
13. Replace batteries if necessary and check out electrical system to make sure all lights and electrical components operate.
14. Check tires for proper cold inflation pressure.
15. After washing accumulated winter grime from the vehicle, it is important to carefully inspect the seams and sealants for separation or cracks that may have appeared around the window frames, vents and any other joints. Re-sealing is quite simple and the material is quickly and easily applied. Appropriate compounds are available from your dealer. Also inspect weather seals around doors, etc., and if necessary, have a dealer replace immediately.

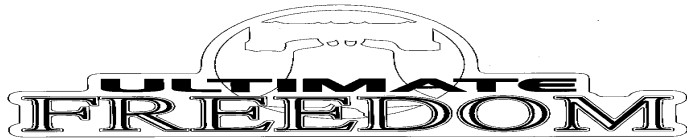

INDEX

110-Volt AC System.....	6- 1	Connecting a Battery Charger.....	3- 3
110-Volt Circuit Breakers.....	6- 5	Connecting Jumper Cables	3- 2
110-Volt Receptacles.....	6- 6	Crank-Out Side Windows.....	8- 30
12-Volt Chassis Circuit Breakers	6- 10	Cruise Control Functions	2- 6
12-Volt DC System.....	6- 10	Cummins Diesel Engine Manual	0- 1
A		D	
About this Manual	0- 1	Diesel Fuel Tank Capacity.....	2- 2
Accumulator Tank	7- 3	Digital Satellite Television System.....	8- 18
Air in the LP Gas Tank	5- 3	Dinette Chairs	8- 23
Antenna Check Light.....	2- 22	Dishwasher.....	8- 9
Antenna Signal Amplifier.....	8- 17	Doors and Windows.....	9- 6
Auto Air Conditioner/Heater	2- 21	Drinking and Driving.....	0- 3
Automatic Coach Leveling System	2- 24	Driver Seat	2- 16
Automotive 12-Volt Fuses and		Driving.....	1- 2
Circuit Breakers	9- 10	Dumping Holding Tanks	7- 7
Auxiliary 110-Volt Generator.....	6- 6	E	
Auxiliary Battery (Aux. Batt) Switch	2- 23	Effects of Prolonged Occupancy	4- 8
B		Electric Entrance Step.....	2- 10
Bathroom	9- 6	Electrical	1- 4
Battery Boost Switch	2- 23	Electronic Compass & Outside	
Battery Condition Meter	8- 9	Thermometer.....	2- 13
Battery Storage and Maintenance	6- 12	Electronic Thermostat.....	8- 13
Bedroom Radio	8- 22	Emergency Exits	1- 6
Before Driving Your Vehicle	2- 1	Engine Block Heater.....	2- 3
Before Driving	0- 2	Engine Cooling System	9- 8
Before Entering Your Vehicle	2- 1	Engine Overheat	3- 3
C		Entrance Door Lock and Handle	2- 8
Cabinetry.....	9- 5	Extend Slideout Rooms	2- 27
Cable TV and Phone Hook-Ups	8- 21	Exterior Entertainment Center	8- 20
Campsite Selection	4- 7	Exterior Feature Identification.....	0- 5
Car or Trailer Towing.....	4- 3	Exterior Shower	7- 6
Carbon Monoxide Alarm	1- 6	Exterior	9- 1
Carbon Monoxide Warning	1- 5	External Power Cord (Shoreline).....	6- 1
Care of Ceiling Fabric.....	9- 3	External Water Supply (City Water)	7- 4
Care of Stripes and Decals.....	9- 2	F	
CB Radio Wiring	2- 23	Fire Extinguisher.....	1- 7
Central Air Conditioner	8- 16	Flat Tire.....	3- 1
Central Vacuum Cleaner.....	8- 21	Formaldehyde Information	1- 5
Charging Section.....	6- 5	Fresh Water System	7- 1
Chassis (Starting) Battery	6- 11	Fresh Water Toilet	8- 29
Child Restraints.....	2- 18	Front Axle Tire Alignment	4- 1
Cold Weather Storage.....	10- 1	Fuel & LP Gas	1- 2
Comfort Controls	2- 21	Fuel Filter/Water Separator	9- 7
Compartment Doors.....	9- 2	Fuel Selection	2- 2
Condenser Coils.....	8- 16		

- G**
 Gas/Electric Water Heater 8- 12
 Gelcoat Fiberglass Finish, Care of..... 9- 1
 General Warnings 1- 1
 Ground Fault Circuit Interrupter..... 6- 6
- H**
 Hazard Warning Flasher 3- 1
 Hazard Warning Lights..... 2- 5
 Headlight Beam Change and Turn Signals... 2- 5
 Headlight Courtesy Flash..... 2- 6
 Heat Pump..... 8- 15
 Horn Bar 2- 6
 House Batteries 6- 11
 House Battery Replacement..... 6- 13
 How LP Gas Works 5- 1
 Humidity and Condensation 4- 8
 Humidity Storage Switch..... 8- 3
 Hydronic Heating System..... 8- 10
- I**
 Ice Maker 8- 3
- J**
 Jacobs Extarder Engine Exhaust
 Braking System..... 2- 4
 Jump Starting 3- 2
- K**
 Key One Lock System 2- 2
 Keyless Remote Entry System..... 2- 9
- L**
 Leveling 4- 7
 Lights 9- 9
 Loading the Vehicle..... 4- 1
 Loading..... 1- 4
 LP Gas Alarm 1- 3
 LP Gas Leaks 1- 3
 LP Gas Leaks 5- 4
 LP Gas Level 8- 8
 LP Gas Output 5- 2
 LP Gas Supply 5- 1
 LP Gas Tank Capacity 5- 3
 LP Tank System..... 5- 2
 Luggage Compartment Doors..... 2- 11
 Lumbar Support 2- 17
- M**
 Maintenance..... 1- 5
 Marker Light Courtesy Flash 2- 6
 Maximum Occupancy..... 4- 3
 Microwave Convection Oven 8- 7
 Mountain Driving 4- 7
- N**
 Nighttime Driving..... 4- 7
- O**
 OnePlace Systems Monitor Panel..... 8- 7
 Options and Equipment 0- 2
 Owner's InfoCase 0- 2
- P**
 Parking Brakes 2- 3
 Passenger Buddy Seat..... 2- 17
 Power Connection..... 1- 4
 Power Converter System 6- 3
 Power Door Lock..... 2- 9
 Power Electric Mirrors..... 2- 12
 Power Roof Vent 8- 29
 Powerline Energy Management System
 (EMS)..... 6- 3
 Preparing Vehicle for Storage..... 10- 1
 Pre-Travel Checklist 4- 4
 Pump Stainer Filter 7- 2
- R**
 Radio Power Switch..... 2- 22
 Recovery Towing..... 3- 1
 Refilling LP Tank 5- 2
 Refrigerator Service Access Compartment... 8- 5
 Refrigerator 8- 1
 Regulator..... 5- 4
 Remote Controlled Spot/Flood Light 2- 16
 Removal from Storage 10- 6
 Reporting Safety Defects 0- 3
 Rest Easy Multi-Position Lounge 8- 26
 Retract Slideout Room..... 2- 27
 Roof Loading 4- 3
 Roof 9- 1
 RV Antifreeze Water Line Winterization
 Systems 10- 4
- S**
 Safe Use of the LP Gas System 5- 1
 Safety Devices 1- 7
 Safety Messages..... 1- 1
 Seat Belt Care and Cleaning 2- 18
 Seat Belts 2- 17
 Seats 2- 16
 Selecting LP Fuel Types 5- 2
 Service and Assistance..... 0- 2
 Severe Weather Information..... 4- 6
 Shower Hose Vacuum Breaker..... 7- 6
 Signal Lever/Headlight Hi/Lo Beam 2- 5
 Sleep Number Bed..... 8- 24

Sleeping Facilities.....	8- 24	Windshield Washers and Wipers.....	9- 9
Slideout Room Extension	2- 26	Winter Use of LP Gas.....	5- 5
Slider Windows.....	8- 31	Wiper Functions.....	2- 7
Smartwheel Steering Wheel Control System	2- 6		
Smoke Alarm	1- 7		
Solar Charger Panel	6- 10		
Sony Rearview TV Monitor System.....	2- 12		
Spartan Chassis Operating Guide	0- 1		
Starting and Stopping Engine	2- 2		
Steering Column Tilt/Telescope	2- 5		
Stepwell Cover.....	2- 11		
Stereo Sound System	2- 22		
Suspension Alignment and Tire Balance.....	9- 9		
T			
Table and Chairs	8- 23		
Tables and Countertop Surfaces	9- 5		
Tank Capacities.....	7- 9		
Tank Monitor Panel	7- 8		
Thermal Overload Protector	6- 5		
Three-Point Lap Shoulder Belts	2- 18		
Tires	9- 8		
Trailer Wiring Connector.....	6- 13		
Travel Straps.....	2- 26		
Travel Tips.....	4- 5		
Travel with LP Gas	5- 3		
TV Antenna.....	8- 17		
U			
Underbody	9- 1		
Upholstery, Carpeting and Draperies.....	9- 2		
Using On-Site Sewer Hook-Ups.....	7- 8		
Utility Light	7- 8		
V			
Vehicle Certification Label.....	0- 4		
Vehicle Maintenance	9- 6		
Video Selector System.....	8- 18		
W			
Warranty	0- 2		
Washer/Dryer Winterizing.....	10- 5		
Washer-Dryer.....	8- 10		
Waste Water System (Holding Tanks)	7- 6		
Water and Holding Tank Levels.....	8- 8		
Water Drain Valves	7- 8		
Water Pump Switch	7- 2		
Water Pump Switch	8- 8		
Water Pump	7- 2		
Water Purifier (Filter) System	7- 5		
Water Stains.....	9- 5		
Weighing Your Loaded Vehicle.....	4- 1		

**IMPORTANT
SERIAL NUMBERS**

Motor Home (Coach): Year _____ Model _____ Serial _____
Chassis: Make _____ Serial (VIN) _____

Roof Air Conditioner:	Brand _____	Model _____	Serial _____
Furnace:	Brand _____	Model _____	Serial _____
Water Heater:	Brand _____	Model _____	Serial _____
Power Converter:	Brand _____	Model _____	Serial _____
110-Volt Generator:	Brand _____	Model _____	Serial _____
Range	Brand _____	Model _____	Serial _____
Microwave Oven:	Brand _____	Model _____	Serial _____
Refrigerator	Brand _____	Model _____	Serial _____
Television:	Brand _____	Model _____	Serial _____
Video Cassette Player:	Brand _____	Model _____	Serial _____

EMERGENCY INFORMATION

Dealer

Name _____

Address _____

Phone _____

INSURANCE POLICY

Company _____

Policy Number _____

Phone _____

