

EKKO

EKKO



*Scan with smartphone  
camera to download the  
app and learn more about  
the EKKO at  
[HowToEKKO.com](http://HowToEKKO.com)*



# TABLE OF CONTENTS

---

## 1 – INTRODUCTION

About this Manual .....	1-1
Safety Messages Used in this Manual .....	1-1
Pre-Delivery Inspection .....	1-2
Before Driving .....	1-2
Front Axle Tire Alignment .....	1-2
Headlight Alignment .....	1-2
Service and Assistance .....	1-2
Reporting Safety Defects .....	1-2
Occupant and Cargo Carrying Capacity Label .....	1-3
Vehicle Certification Label .....	1-4
Specifications and Capacities .....	1-5
Owner and Vehicle Information .....	1-6

## 2 – SAFETY AND PRECAUTIONS

General Warnings .....	2-1
Driving Safety .....	2-2
Fuel and Propane Gas .....	2-2
Propane Gas Leaks .....	2-4
Propane Gas Leak Detector .....	2-4
Carbon Monoxide Alarm .....	2-5
Carbon Monoxide Warning .....	2-5
Smoke Alarm .....	2-6
Fire Extinguisher .....	2-6
Electrical .....	2-6
Loading .....	2-7
Maintenance .....	2-7
Emergency Exits .....	2-7
Formaldehyde Information .....	2-7
Mold, Moisture, and Your Motorhome .....	2-8
Roof and Ladders .....	2-9
Roadside Emergency .....	2-9
Jump Starting .....	2-10
Engine Overheat .....	2-10

## 3 – DRIVING YOUR MOTORHOME

Seats – Driver/Co-Pilot .....	3-1
Seat Belts .....	3-1
Child Restraints .....	3-2
Keys .....	3-3
Blind Spot detection system .....	3-3
Mirrors – Power Exterior .....	3-4

---

## Table Of Contents

---

Hazard Warning Flashers .....	3-4
Battery Boost Switch .....	3-5
Air Conditioner/Heater – Automotive (Dash) .....	3-5
Radio – In-Dash .....	3-5
Rearview Mirror with Monitor System .....	3-5
Engine Cooling System .....	3-6
Tires .....	3-6
Suspension Alignment and Tire Balance .....	3-6
Lights .....	3-6

### **4 – APPLIANCES AND SYSTEMS**

Refrigerator .....	4-1
Range Top .....	4-2
Microwave Oven .....	4-3
Tailgate package (Model 622a) .....	4-3
Systems Monitor Panel .....	4-6
Solar Charge Panel .....	4-7
Heating System – Furnace .....	4-8
Water Heater – Gas Tankless with Decalcification .....	4-9
Ducted Roof Air Conditioning System .....	4-10

### **5 – PROPANE GAS**

Propane Gas Supply .....	5-1
Safe Use of the Propane Gas System .....	5-3
Propane Gas Warnings and Precautions .....	5-4
Propane Gas Pressure Regulator – Removable LP Tank .....	5-5
Propane Vaporization in Cold Weather .....	5-5

### **6 – ELECTRICAL**

Electrical Cautions .....	6-1
Electrical System – House 120-Volt AC .....	6-1
Power Cord – External (Detachable) .....	6-1
Inverter/Charger Unit – 2000W (Pure Sine Wave) .....	6-2
Circuit Breakers – House 120-Volt AC .....	6-4
Electrical Outlets – House 120-Volt AC .....	6-4
Ground Fault Circuit Interrupter .....	6-4
Electrical Generator .....	6-5
lithium Battery .....	6-6
House/Coach Battery Disconnect Switch .....	6-8
Battery Access .....	6-8
Circuit Breakers and Fuses – House 12-Volt DC .....	6-9

### **7 – PLUMBING**

Service Light .....	7-1
Fresh Water System .....	7-1
Water Pump .....	7-2
Cold Water Filter .....	7-4

---



Disinfecting Your Fresh Water System .....	7-5
Shower Hose Vacuum Breaker .....	7-7
Exterior Shower/Wash Stations .....	7-7
Toilet .....	7-8
Waste Water System (MODEL 622A) .....	7-9
Waterline & Tank Drain Valves .....	7-10
Winterizing Procedure .....	7-10
Water System Drain Valve Locations .....	7-22

## **8 – ENTERTAINMENT**

Audio/Video System Basic Operation .....	8-1
BLUE-RAY DISK™ Player With dvd .....	8-1
TV Antenna – Digital .....	8-1
TV Signal Amplifier .....	8-1
TV Digital Satellite System Wiring .....	8-2
Satellite Dish and Cable TV Connections (Input) .....	8-2
Access Port (Roof) .....	8-3

## **9 – FURNITURE AND SOFTGOODS**

Cab Seat Lounge Cushion .....	9-1
Dinette Table (Portable) .....	9-1
Dinette Table .....	9-2
Sleeping Facilities .....	9-3
Bed – Deluxe Sleep System .....	9-3
Pop-top Sleep System .....	9-3
Wood Furniture and Cabinetry .....	9-6

## **10 – MAINTENANCE AND STORAGE**

Sealants – Inspection and General Information .....	10-1
Roof .....	10-1
Undercarriage .....	10-2
Exterior Automotive Paint Finish .....	10-2
Exterior Graphic Care .....	10-4
Plastic Parts – Cleaning .....	10-5
Exterior Lights .....	10-5
Interior Soft Goods .....	10-5
Cabinetry – Cleaning .....	10-6
Decorative Vinyl Wall Paneling – Cleaning .....	10-6
Tables and Countertops .....	10-7
Sink – Stainless Steel .....	10-7
Range and Refrigerator .....	10-7
Vinyl Flooring .....	10-7
Bathroom .....	10-8
Doors and Windows .....	10-9
Vehicle Usage In Cold Weather .....	10-9
Vehicle Storage – Preparation .....	10-9

---

## Table Of Contents

---

Vehicle Storage – Removal .....	10-10
Chassis Service and Maintenance .....	10-11
Motorhome Maintenance Chart .....	10-12

### **11 – MISCELLANEOUS**

Loading the Vehicle .....	11-1
Weighing Your Loaded Vehicle .....	11-1
Car or Trailer Towing .....	11-3
Trailer Wiring Connector .....	11-4
Towing Guidelines .....	11-4
Gear Garage .....	11-5
Manual Awning .....	11-7
Power Awning .....	11-8
Storage Compartment Doors .....	11-10
Roof Ladder .....	11-10
Power Roof Ventilator .....	11-11
Luggage Rack .....	11-11
Windows .....	11-12
Effects of Prolonged Occupancy .....	11-12

---

# SECTION 1 – INTRODUCTION

---

Congratulations! We welcome you to the exciting world of motorhome travel and camping. You will find it convenient and enjoyable to have all the comforts of home and still enjoy the great outdoors wherever you choose to go.

Before sliding into the driver's seat, please become familiar with operations and features. In addition, spend some time with the dealer when you take delivery to learn all you can about your new motorhome.

---

---

## ABOUT THIS MANUAL

This operator's manual was prepared to aid you in the proper care and operation of the vehicle and equipment.

Please read this manual completely to understand how everything in your motorhome works before taking it on its "maiden voyage". In addition, please become familiar with the New Vehicle Limited Warranty.

*NOTE: This manual describes many features of your motorhome and includes instructions for its safe use.*

*This manual, including photographs and illustrations, is of a general nature only.*

***Some equipment and features described or shown in this manual may be optional or unavailable on your model.***

*Because of Winnebago Industries<sup>®</sup>, continuous program of product improvement, it is possible that recent product changes and information may not be included.*

*The instructions included in this manual are intended as a guide, and in no way extend the responsibilities of Winnebago Industries beyond the standard written warranty as presented in this manual.*

*The descriptions, illustrations, and specifications in this manual were correct at the time of printing. We reserve the right to change specifications or*

*design without notice, and without incurring obligation to install the same on products previously manufactured.*

The materials in your InfoCase contain warranty information and operating and maintenance instructions for the various appliances and components in your motorhome.

*NOTE: Many of the instruction sheets and manuals for the various appliances and components have been incorporated into the Operator's Manual Supplement for your convenience.*

*Please read the FAQ in Section 1 of the Operator's Manual Supplement for more details.*

Throughout this manual, frequent reference is made to the vehicle chassis manual that is provided by the manufacturer of the chassis on which this motorhome is built.

Consult the chassis manual for operating, safety, and maintenance instructions pertaining to the chassis section of the motorhome.

---

---

## SAFETY MESSAGES USED IN THIS MANUAL

Throughout this manual, certain items are labeled Danger, Warning, Caution, Notice, or Note. These terms alert you to precautions that may involve damage to your vehicle or a risk to your personal safety. Read and follow them carefully.



DANGER indicates a hazardous situation which, if not avoided, will result in death or serious personal injury.

## SECTION 1 – INTRODUCTION

---



### **WARNING**

WARNING indicates a hazardous situation which, if not avoided, could result in death or serious personal injury.



### **CAUTION**

CAUTION indicates a hazardous situation which, if not avoided, could result in minor or moderate personal injury.

### **NOTICE**

NOTICE is used to address practices not related to personal injury.

*NOTE: A “Note” is not necessarily safety-related, but indicates a recommendation or special point of information that could assist in understanding the use or care of a feature item.*

---

## **PRE-DELIVERY INSPECTION**

This motorhome has been thoroughly inspected before shipment. Your dealer is responsible for performing a complete pre-delivery inspection of the chassis and all motorhome components.

As a part of the pre-delivery inspection procedure, the dealer is responsible for road testing the motorhome, noting, and correcting any problems before delivery.

---

## **BEFORE DRIVING**

Familiarize yourself with State/Province and local regulations before traveling. There are many local rules that may impact your travels.

---

---

## **FRONT AXLE TIRE ALIGNMENT**

We recommend that you have the front suspension and steering alignment checked and adjusted after you have fully loaded the vehicle according to your needs. Thereafter, have alignment inspected periodically to maintain vehicle steering performance and prevent uneven tire wear.

---

---

## **HEADLIGHT ALIGNMENT**

Headlights on this motorhome were aligned at the factory in an unloaded state. We recommend you have the high and low beam alignment checked after fully loading the vehicle to your needs. Thereafter, have the alignment inspected periodically to maintain visibility.

---

---

## **SERVICE AND ASSISTANCE**

Your dealer will be glad to provide any additional information you need, as well as answer any questions you might have about operating the equipment in your motorhome. When it comes to service, remember that your dealer knows your vehicle best and is interested in your satisfaction. Your dealer will provide quality maintenance and any other assistance that you may require during your ownership of this vehicle.

If you need warranty repairs while traveling, you may take your vehicle to any authorized Winnebago Industries® dealership and request their assistance.

See the Service Dealer Directory in your InfoCase.

---

---

## **REPORTING SAFETY DEFECTS**

If you believe that your vehicle has a defect which could cause a crash or could cause injury or death, you should immediately inform the National Highway Traffic Safety Administration (NHTSA) in addition to notifying Winnebago Industries, Inc.

If NHTSA receives similar complaints, it may open an investigation, and if it finds that a safety defect exists in a group of vehicles, it may order a recall and remedy campaign. However, NHTSA cannot become involved in individual problems between you, your dealer, or Winnebago Industries, Inc.

To contact NHTSA, you may either call the Vehicle Safety Hotline toll-free at: 1-888-327-4236; (TTY: 1-800-424-9153) or go to <http://www.safercar.gov> or write to:

Administrator, NHTSA  
1200 New Jersey Avenue S.E.  
Washington, D.C. 20590

You can also obtain other information about motor vehicle safety at <http://www.safercar.gov>.

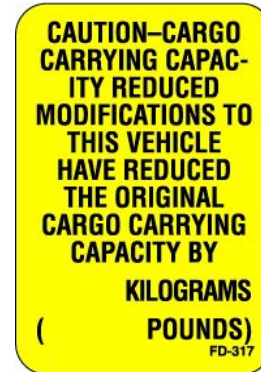

## **OCCUPANT AND CARGO CARRYING CAPACITY LABEL**

This label is affixed in the driver’s area next to or near the Vehicle Certification Label. It contains vehicle occupant and cargo carrying capacity along with the number of seat belt positions in the vehicle. The label also provides the weight of a full load of water and advises that this weight, along with the tongue weight counts as cargo.

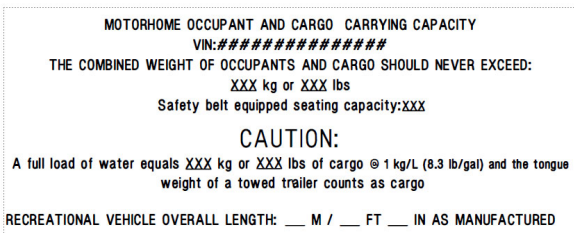

If any weight exceeding 45.4 kg (100 lbs.) is added to your motorhome between final vehicle certification and first retail sale, the occupant and cargo carrying capacity must be corrected and a label similar to the one shown in the following photo will be affixed inside your motorhome.

# SECTION 1 – INTRODUCTION

## VEHICLE CERTIFICATION LABEL

This label is affixed to the lower driver side armrest panel, driver door, or the driver side door jamb, depending on model. It contains vehicle identification numbers and other important reference information.

MANUFACTURED BY WINNEBAGO IND. INC.	3	INCOMPLETE VEHICLE MANUFACTURED BY 1 GVWR 4 LB	2	COLD INFLATION PRESSURE 8 PSI KPA 9	
GAWR: FRT 5 LB KG RR LB KG	SUITABLE TIRE AND RIM CHOICE TIRE 6 RIM 7	COLD INFLATION PRESSURE 8 PSI KPA 9			
THIS VEHICLE HAS BEEN COMPLETED IN ACCORDANCE WITH THE PRIOR MANUFACTURER'S IVD, WHERE APPLICABLE. THIS VEHICLE CONFORMS TO ALL APPLICABLE FEDERAL MOTOR VEHICLE SAFETY STANDARDS IN EFFECT ON THE DATE OF MANUFACTURE SHOWN ABOVE.					
SERIAL NO. 10 XXXXX XXXX XX XX/XX/XX XXX-XXXXX	VIN 11 14	TYPE 12 15	COLOR 13 XXXXXX-XXX		

### EXPLANATION OF DATA

1. Chassis manufacturer.
2. Chassis manufacture date.
3. Month and year of manufacture at Winnebago Industries®.
4. Gross Vehicle Weight Rating: Total permissible weight of the vehicle, including driver, passengers, total cargo carried (including all liquids), and equipped with all options.
5. Gross Axle Weight Rating: Total permissible weight allowed for the front and rear axles (listed in pounds and kilograms).
6. Suitable Tire Choice: Tires recommended to meet handling and safety requirements. When replacing any of the tires on your vehicle, always replace with a tire that meets these specifications.
7. Suitable Rim Choice: Wheel rims recommended to meet handling and safety requirements. When replacing any of the rims on your vehicle, always replace with a rim that meets these specifications.
8. Cold Inflation Pressure: Inflation pressures at Gross Axle Weight Ratings recommended (while cold) for the tires originally equipped on your vehicle. These pressure levels must be maintained to assure proper handling, safety, and fuel economy.
9. Rear Axle Wheel Configuration: Single or Dual as it relates to the inflation.
10. Serial Number: This is the serial number assigned to the completed vehicle by Winnebago Industries.
11. Vehicle Identification Number (VIN): This number identifies the chassis on which the motorhome is built. The 10th digit of the VIN designates the chassis model year (J=2018, K=2019, L=2020 etc.). This information is useful when ordering chassis repair parts.
12. Type: States the NHTSA designated usage classification for your motorhome. MPV signifies a Multi-purpose Passenger Vehicle.
13. Color: Signifies the color code number of the decor used throughout the vehicle. This number is necessary for ordering replacement cushions, curtains, carpet, etc.
14. Winnebago® model year and series/family name.
15. Model: Lists the Winnebago product model number of your vehicle.

## **SPECIFICATIONS AND CAPACITIES**

<b>Ekko</b>	
	<b>22A</b>
	<b>Ford® Transit Cab Chassis, 3.5L EcoBoost, AWD</b>
Length	23'
Exterior Height <sup>1</sup>	10' 6"
Exterior Width	7' 2.5"
Awning Length	13'
Interior Height	6' 8"
Interior Width	6' 9"
Freshwater Tank Capacity <sup>2</sup>	50 gal.
Water Heater Capacity	Continuous
Holding Tank Capacity - Black <sup>2</sup>	N/A
Holding Tank Capacity - Gray-1 <sup>2</sup>	51 gal.
Cassette Toilet Capacity	5 gal.
Propane Capacity <sup>3</sup>	40 lbs.
Wheelbase	156"
GVWR	11,000 lbs.
GAWR - Front	4,630 lbs.
GAWR - Rear	7,275 lbs.
GCWR <sup>4</sup>	15,000 lbs.
Fuel Capacity	31 gal.

**Notes:**

All information is based upon the most recent data available. Visit the Winnebago Industries, Inc. web page – [www.winnebagoind.com](http://www.winnebagoind.com) – for the most current product information.

<sup>1</sup> The height of each model is measured to the top of the tallest standard feature and is based on the curb weight of a typically equipped unit. The actual height of your vehicle may vary by several inches depending on chassis or equipment variations. Contact your dealer for further information.

<sup>2</sup> Capacities are based on measurements prior to tank installation. Slight capacity variations can result upon installation.

<sup>3</sup> Capacities shown are the tank manufacturer's listed water capacity (W.C.). Actual filled propane capacity is 80% of listing due to overfilling prevention device on tank.

<sup>4</sup> Actual towing capacity is dependent on your particular loading and towing circumstances which includes the GVWR, GAWR, and GCWR as well as adequate trailer brakes. Refer to the chassis operator's manual of your motor home for further towing information.

**SECTION 1 –  
INTRODUCTION**

---

---

**OWNER AND VEHICLE INFORMATION**

**OWNER INFO**

Owner's Name(s) \_\_\_\_\_

Address \_\_\_\_\_

\_\_\_\_\_

**VEHICLE INFORMATION**

Motorhome Model Number \_\_\_\_\_

Motorhome Serial Number \_\_\_\_\_

Chassis Vehicle Identification No. (VIN) \_\_\_\_\_

Vehicle Mileage at Delivery \_\_\_\_\_

Selling Dealer Name \_\_\_\_\_

Address \_\_\_\_\_

\_\_\_\_\_

**YOUR WINNEBAGO INDUSTRIES® DEALER /SERVICE CENTER**

Name \_\_\_\_\_

Address \_\_\_\_\_

\_\_\_\_\_

Contact \_\_\_\_\_ Phone \_\_\_\_\_

**CHASSIS SERVICE CENTER**

Name \_\_\_\_\_

Address \_\_\_\_\_

\_\_\_\_\_

Contact \_\_\_\_\_ Phone \_\_\_\_\_

**RV INSURANCE POLICY**

Company \_\_\_\_\_

Policy Number \_\_\_\_\_

Agent \_\_\_\_\_ Phone \_\_\_\_\_



## SECTION 2 – SAFETY AND PRECAUTIONS



---

---

### GENERAL WARNINGS

- Only seats equipped with seat belts are to be occupied while the vehicle is moving.
- Make sure all passengers have seat belts fastened. Lap belts should fit low on the hips and upper thighs. The shoulder belt should be positioned snug over the shoulder.
- For pregnant women: Never place the shoulder belt behind your back or under your arm. Adjust the lap belt across your hips/pelvis, and below your belly. Place the shoulder belt across your chest (between your breasts) and away from your neck.
- Child restraints should be installed properly according to manufacturer's instructions. See "Child Restraints".
- All moveable or swiveling seats should be placed and locked in travel position while the vehicle is moving.
- Never let passengers stand or kneel on seats while the vehicle is moving.
- Sleeping facilities are not to be utilized while vehicle is moving.
- Examine the escape window and be familiar with its operation.
- Inspect the fire extinguisher monthly for proper charge and operating condition. This should also be done before beginning a vacation or any extended trip.



### WARNING

Operating, servicing and maintaining this vehicle can expose you to chemicals including engine exhaust, carbon monoxide, phthalates, and lead, which are known to the State of California to cause cancer and birth defects or other reproductive harm. To minimize exposure, avoid breathing exhaust, do not idle the engine except as necessary, service your vehicle in a well-ventilated area and wear gloves or wash your hands frequently when servicing your vehicle. For more information go to [www.P65Warnings.ca.gov/passenger-vehicle](http://www.P65Warnings.ca.gov/passenger-vehicle).



## SECTION 2 – SAFETY AND PRECAUTIONS

---

---

### DRIVING SAFETY



#### WARNING

This motorhome has been designed, manufactured and tested with concern for the protection of its occupants. We recommend you perform the following inspections for your safety and the safety of your passengers before starting your vehicle.

1. LP GAS SYSTEM - Turn off at tank for traveling. Test for leaks upon arrival at destination before lighting pilots.
  2. WHEELS - Inspect for damage and check lug nuts for tightness.
  3. TIRES - Inspect for wear and damage and check for recommended air pressure.
  4. LIGHTING - Test for proper operation of all interior and exterior lights including dash lights, headlights, tail lights, brake lights, clearance lights, and turn signals.
  5. EXITS - Inspect release mechanism on emergency exit window, test both locks on main entrance door for ease of operation and instruct passengers how to use both means of exit.
  6. SEAT BELTS - Direct passengers to designated seats, be certain swivel seats are locked into position, and require use of a seat belt. See operator's manual for occupancy and weight restrictions.
  7. APPLIANCES - Turn off and latch or lock doors where provided.
  8. LOOSE PARCELS - Store securely.
  9. UTILITY SUPPLY LINES - Disconnect all electrical, sewer and water lines and secure properly.
  10. ENTRANCE DOOR STEP - Assure step is in retracted position for traveling.
- Read your motorhome and chassis owner's manual for further precautions.

- Do not operate the cruise control on icy or extremely wet roads, winding roads, in heavy traffic, or in any other traffic situation where a constant speed cannot be maintained.
- Use care when accelerating or decelerating on a slippery surface. Abrupt speed changes can cause skidding and loss of control.
- Never drive the vehicle with a slideout room extended.
- Driving through water deep enough to wet the brakes may affect stopping distance or cause the vehicle to pull to one side. Check brake operation in a safe area to be sure they have not been affected. Never operate any vehicle if a difference in braking efficiency is noticeable.
- Adverse weather conditions and extremes in terrain may affect handling and/or performance of your vehicle. Refer to your chassis manual for complete and related information on driving your vehicle.
- Doors - Verify all interior and exterior doors are shut and/or stowed and latches are in place where provided.

---

---

### FUEL AND PROPANE GAS



#### DANGER

All pilot lights, appliances, and their ignitors (see operating instructions) shall be turned off before refueling of motor fuel tanks and/or propane containers. Can cause ignition of flammable vapors, which can lead to a fire or explosion and result in death or serious injury.

- Do not attempt to adjust the driver's seat while the vehicle is moving.
- Do not adjust tilt steering in a moving vehicle.



 **WARNING**

Do not fill propane container(s) to more than 80 percent of capacity. A properly filled container contains approximately 80 percent of its volume as liquid propane. Overfilling propane container(s) can result in uncontrolled propane flow, which could lead to a fire or explosion and result in death or serious injury.

 **WARNING**

Do not place propane cylinders inside the vehicle. Propane cylinders are equipped with safety devices that relieve excessive pressure by discharging propane to the atmosphere. Propane gas is highly flammable. Can lead to a fire or explosion and result in death or serious injury.

- Do not place or store gasoline or other flammable liquid containers inside the vehicle.
- All pilot lights must be extinguished and appliances turned off while refilling the fuel tank or propane gas tank.
- Never smoke while refilling vehicle fuel tank or propane gas tank.
- Never use an open flame to test for propane gas leaks. Replace all protective covers and caps on propane system after filling. Make sure valve is closed and the door is latched securely.
- Never connect natural gas to the propane gas system.
- **Do not** turn burner controls to “On” and allow gas to escape before using ignitor or lighting a match.

- Portable fuel-burning equipment, including wood and charcoal grills and stoves shall not be used inside the recreational vehicle. The use of this equipment inside the recreational vehicle may cause fires or asphyxiation.
- Propane gas regulators must always be installed with the diaphragm vent facing downward. Regulators are equipped with a protective cover. Make sure that the regulator vent faces downward and that the cover is kept in place to minimize vent blockage, which could result in excessive gas pressure causing fire or explosion.
- The following warning label is located in the cooking area to remind you to provide an adequate supply of fresh air for combustion.

 **DANGER**

Do not use gas cooking appliances for comfort heating. Can lead to carbon monoxide poisoning, which can lead to death or serious injury.

 **WARNING**

Gas cooking appliances need fresh air for safe operation.  
Before operating:  
Open vents or windows slightly or turn on exhaust fan prior to using cooking appliance. Gas flames consume oxygen, which should be replaced to ensure proper combustion. Improper use can result in death or serious injury.

Unlike homes, the amount of oxygen supply is limited due to the size of the recreational vehicle, and proper ventilation when using the cooking appliance(s) avoids dangers of asphyxiation. It is especially important that cooking appliances not be used for comfort heating, as the danger of



## SECTION 2 – SAFETY AND PRECAUTIONS

asphyxiation is greater when the appliance is used for long periods of time. Failure to comply could result in death or serious injury.

### PROPANE GAS LEAKS

Check propane gas system for leaks yearly, or as necessary.

The following label is located in the vehicle near the range area. If you smell gas within the vehicle, quickly and carefully perform the procedures listed.



Propane Gas Leak Detector

### DANGER

#### IF YOU SMELL PROPANE

1. Extinguish any open flames and all smoking materials.
2. Shut off the propane supply at the container valve(s) or propane supply connection.
3. Do not touch electrical switches.
4. Open doors and other ventilating openings.
5. Leave the area until odor clears.
6. Have the propane system checked and leakage source corrected before using again.

Ignition of flammable vapors could lead to a fire or explosion and result in death or serious injury.

### WARNING

**EXPLOSION HAZARD: DO NOT** use an open flame to test for gas leaks. When testing for gas line leaks with a soapy water solution, **DO NOT** use a detergent containing ammonia or chlorine. These substances may generate a chemical reaction causing corrosion to gas lines, resulting in dangerous leak conditions. Death or serious injury can result.

### Power Connection

The Propane Gas Leak Detector is powered by the house batteries. If the House/Coach Battery Disconnect switch is shut off or the battery cable is disconnected from the batteries, the alarm will not work. The Propane Gas Leak Detector fuse or circuit breaker is located in the 12-volt house electrical load center.

Because the Propane Gas Leak Detector is connected to the house battery, it is always drawing a small amount of current. Even though this current draw is slight, it could drain the house battery during storage periods when the house battery will not be charged regularly by the engine or shoreline.

### Replacement

When replacing this alarm, we recommend replacing only with the same model, or with one that is also listed for RV application. We recommend obtaining a replacement from your Winnebago Industries® dealer.

### PROPANE GAS LEAK DETECTOR

Your motorhome is equipped with a Propane Gas Leak Detector, similar to the one shown in the following photo. The leak detector sounds an alarm if an unsafe amount of propane gas is present inside the motorhome.



### Further Information

See the manufacturer’s user guide provided in your InfoCase for further instructions.

## CARBON MONOXIDE ALARM

Your motorhome is equipped with a Carbon Monoxide (CO) Alarm, which has a sensor that is designed to detect toxic carbon monoxide gas fumes resulting from incomplete combustion of fuel. It will detect CO gas from any combustion source such as the furnace, gas range/oven, water heater, refrigerator, chassis engine, and electric generator engine.

To reduce the risk of carbon monoxide poisoning, test this alarms operation after the motorhome has been in storage, before each trip, and at least once per week during use by pressing the Test/Reset button on the alarm.



Carbon Monoxide Alarm

 <b>WARNING</b>
Failure to replace this product by the “REPLACE BY DATE” printed on the alarm cover may result in death by Carbon Monoxide poisoning.

### Replacement

When replacing this alarm, we recommend replacing only with the same model, or with one that is also listed for RV application. We recommend obtaining a replacement from your Winnebago Industries® dealer.

### Further Information

Please read the information provided by the manufacturer, which is included in your InfoCase for further information.

## CARBON MONOXIDE WARNING

 <b>WARNING</b>
Avoid inhaling exhaust gases, as they contain carbon monoxide, which is a colorless, odorless, and poisonous gas. Death or serious injury can result.

The best protection against carbon monoxide entry into the vehicle body is a properly maintained engine exhaust and ventilation system. It is recommended that the exhaust system and body be inspected by a qualified motorhome service center:

- Each time the vehicle is serviced for an oil change.
- Whenever a change in the sound of the exhaust system is noticed.
- Whenever the exhaust system, underbody, or rear of the vehicle is damaged.

To allow proper operation of the vehicle’s ventilation system, keep front ventilation inlet grill clear of snow, leaves, or other obstructions at all times. **DO NOT OCCUPY A PARKED VEHICLE WITH ENGINE RUNNING FOR AN EXTENDED PERIOD.**

Do not run engine in confined areas, such as a garage, except to move vehicle into or out of the area.



## SECTION 2 – SAFETY AND PRECAUTIONS

### SMOKE ALARM

Your motorhome is equipped with a Smoke Alarm (located on the ceiling in the lounge area.) The Smoke Alarm is powered by a 9-volt battery and has a sensor that is designed to detect smoke.



Smoke Alarm

The following label is affixed to the Smoke Alarm.

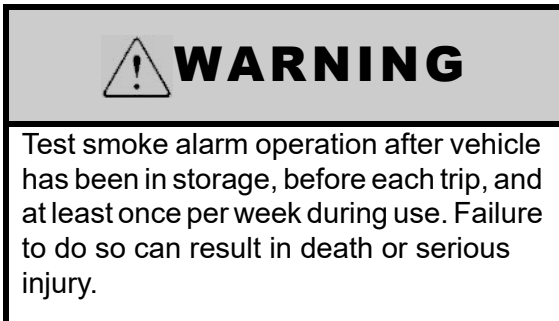

### Replacement

When replacing this alarm, we recommend replacing only with the same model, or with one that is also listed for RV application. We recommend obtaining a replacement from your Winnebago Industries® dealer.

### Expiration and Further Information

See the manufacturer's information in your InfoCase for smoke alarm expiration and further instructions.

### FIRE EXTINGUISHER

A dry chemical Fire Extinguisher is located near the main entrance door.

We recommend that you become thoroughly familiar with the operating instructions displayed on the side of the Fire Extinguisher and in the information supplied in your InfoCase.

We also recommend that you inspect the Fire Extinguisher for proper charge at least once a month in accordance with National Fire Protection Association (NFPA) recommendations as stated on the label.

If the extinguisher is past its expiration date or charge is insufficient, the Fire Extinguisher must be replaced.

### NOTICE

Do not test the fire extinguisher by discharging it. Partial discharge can cause leakage of pressure or contents, which would render the unit inoperative when needed. When using the fire extinguisher, aim the spray at the base of the fire.

### Replacement

If for any reason you must replace the Fire Extinguisher, the replacement must be the same type and size as the one originally supplied in your motorhome. We recommend obtaining a replacement only from your Winnebago Industries® dealer or a reliable RV parts supplier.

### ELECTRICAL

- Careless handling of electrical components can be fatal. Never touch or use electrical components or appliances while feet are bare, while hands are wet, or while standing in water or on wet ground.





- Improper grounding of the vehicle can cause personal injury. Do not plug the utility power cord into an outlet which is not grounded and do not adapt the plug to connect to a receptacle for which it is not designed.
- Do not attach an extension cord to the utility power cord.
- Do not use any electrical device that has had the ground pin removed.
- Avoid overloading electrical circuits. Replace fuses or circuit breakers with those of the same size and amperage rating only. Never use a higher rated fuse or breaker.
- Use caution when handling or working near electrical storage batteries. Always remove jewelry and wear protective clothing and eye covering. Avoid creating sparks.

---

---

### LOADING

- Store or secure all loose items inside the motorhome before traveling. Possible overlooked items such as canned goods or small appliances on the countertop, cooking pans on the range, or free-standing furniture items can become dangerous projectiles during a sudden stop.
- Be aware of GVWR, GAWR, and individual load limit on each tire or set of duals (See “Loading the Vehicle” in *Section 12 - Miscellaneous*).
- Never load the motorhome in excess of the gross vehicle weight rating or the gross axle weight rating for either axle.

---

---

### MAINTENANCE

- Do not remove the radiator cap while engine and radiator are still hot. Always check coolant level visually at the see-through coolant reservoir.
- Never get beneath a vehicle that is held up by a leveling system (if equipped), or a jack only.
- Always release the air prior to getting under the vehicle (if equipped).

- Do not mix different construction types of tires on the vehicle, such as radial, bias, or belted tires, as vehicle handling may be affected. Replace tires with exact size, type, and load range.
- Refer to the chassis manual for complete maintenance precautions and recommendations.

---

---

### EMERGENCY EXITS

#### Escape Window

The escape window is secured by four red safety latches at the bottom or side of the window.

To open, lift all latches up and toward the center of the window, then push outward near the bottom of the window.

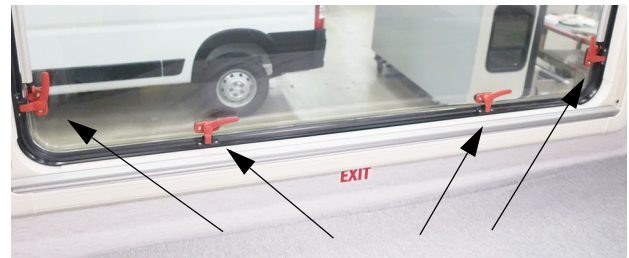

Escape Window

(Lift all red safety latch handles towards the center of the window and push window OUT)  
-Typical View

---

---

### FORMALDEHYDE INFORMATION

Some of the materials used in this recreational vehicle emit formaldehyde. Eye, nose, and throat irritation, headache, nausea, and a variety of asthma-like symptoms, including shortness of breath have been reported as a result of formaldehyde exposure. Reaction to formaldehyde exposure may vary among individuals. Elderly persons and young children, as well as anyone with a history of asthma, allergies, or lung problems may be at greater risk. Research is continuing on the possible long-term effects of exposure to formaldehyde. Inadequate



## SECTION 2 – SAFETY AND PRECAUTIONS

---

ventilation may allow formaldehyde and other contaminants to accumulate in indoor air. Ventilation to dilute the indoor air may be obtained from a passive or mechanical ventilation system. Always be sure to thoroughly ventilate your recreational vehicle before and during each use. High indoor temperatures and humidity may raise formaldehyde levels. When a recreational vehicle is in areas subject to high temperatures, an air conditioning system can be used to control indoor temperature levels. If you have any questions regarding the health effects of formaldehyde, consult your doctor or local health department.

---

---

### **MOLD, MOISTURE, AND YOUR MOTORHOME**

#### **What is Mold?**

Molds are part of the natural environment. They are as old as the Earth itself and mold spores are almost everywhere at some level waiting to grow. Mold plays a part of nature by breaking down dead organic matter, such as fallen leaves and dead trees. Indoors however, mold growth should be avoided. Molds reproduce by means of tiny spores. Those spores are invisible to the naked eye and float throughout the outdoor and indoor air. Because of the nature of the use of a motorhome, it is natural for a motorhome to be introduced into an environment with mold spores.

Mold is a plant and requires its own special environment to grow. That environment includes organic materials, nutrients, moisture, and proper temperature.

#### **How Can I Avoid Mold?**

To reduce the ability for mold to grow, you must reduce what constitutes its growth environment. Mold can grow with the smallest of a nutrient base. Just small amounts of dirt or dust on the carpet can be enough to allow the mold process to begin. Keep the environment as clean as possible. Vacuum the carpet. Clean food spills

thoroughly and quickly. Avoid grease buildup near the stove or sink. Clean the exhaust fan above the stove often.

Minimize moisture in your motorhome and keep humidity low. Clean spills quickly. Do not allow condensation to build up. You can open windows and vents to minimize condensation. Use of the air conditioner can assist in removing moisture from the air. Avoid leaks, but if leaks do occur, make repairs promptly.

Avoid bringing mold into your motorhome. Plants, cloths, books, and other household items may already have mold present. It is easy to transfer mold into your motorhome environment.

Monitor your motorhome. Periodically check those hidden areas in corners, closets, and cabinets to assure mold is not present.

#### **What if I Find Mold?**

If mold develops, clean the area with a concentrate of soap and bleach. Items that contain mold that cannot be cleaned should be removed from the vehicle.

#### **Can Mold Harm Me?**

The effects of mold and airborne mold spores may cause irritation to some people. Experts disagree on the level of exposure that may cause health concerns.

#### **If Mold Is Present, What Will Winnebago Industries® Do?**

If Winnebago Industries determines that mold is present in the motorhome as a result of a manufacturing defect reported to Winnebago Industries within the limited warranty period, Winnebago will clean the affected area(s) and/or replace affected items as it deems necessary. This is the extent of coverage provided by Winnebago Industries. Winnebago Industries, however, will not assume responsibility for mold deemed to be a result of a motorhome users lack of timely and appropriate action to mitigate circumstances should a problem occur.

If Winnebago Industries determines that mold is present due to conditions it determines is not a result of a manufacturing defect found within the





warranty period, Winnebago Industries will not provide any financial assistance to the repair of the condition.

---

---

## ROOF AND LADDERS

### –If Equipped

 <b>WARNING</b>
STAY OFF ROOF. Surface may be slippery. Falling could result in death or serious injury.

The ladder on your motorhome is provided for limited access to the roof.

Walking or working on the roof should be left to qualified service personnel using proper safety equipment in a safe environment. You should only walk or work on the roof if you are qualified and have created a safe environment.

For your safety, it is not recommended that you store or carry items on the roof.

### Before Using the Ladder

- **Inspect the ladder** to make sure it is not damaged. Never use a damaged ladder.
- **Keep the rungs of the ladder clean and dry** while in use. Never use the ladder when it is raining, snowing, or icy. The rungs can become slippery. Do not step onto the rungs if the rungs are wet, or if your shoes are wet or carry mud or debris that could result in a loss of footing.
- **Never ignore warning labels** or weight limits defined on your ladder. The following warning label is located on or near the ladder:

 <b>WARNING</b>
Do not exceed 225-lb. maximum weight capacity. Misuse of ladder could result in death or serious injury. See Operator's Manual before using ladder.

- **Maximum Capacity: 225 lbs.**
- **Do not overload.** Ladder is intended for one person.
- **Make sure you are physically capable** to safely use the ladder. Strength, flexibility, and stability are required.
- **Be aware that the vehicle may sway** as you climb the ladder. Do not use the ladder in high winds.
- **As you climb the ladder,** grasp the side rails firmly and always use both hands. Keep your body centered between the side rails. Do not over-reach.
- **Never allow children** on the ladder.
- **Do not transport items** anchored to the ladder. You could damage the ladder.

---

---

## ROADSIDE EMERGENCY

Because of the size and weight of this vehicle and its tires, and the possible complications involved in tire changing, we strongly advise obtaining professional road service to change a flat tire whenever possible. However, if an emergency requires you to change the tire yourself, please exercise extreme caution and read all tire changing information in the chassis manual.

Never get beneath a vehicle that is held up by a jack only.

### If You Get A Flat Tire

- DO NOT panic.
- Grip the steering wheel firmly and steer the vehicle as straight as possible. Avoid quick maneuvers. You may need to counter-steer to compensate for “pull” created by the failed tire.
- DO NOT stomp on the brake. This abruptly shifts the vehicle’s weight forward, making it nose-dive and pull toward the blown-out side.
- DO NOT jerk your foot off the accelerator. Just ease back on the accelerator slowly and gently to continue momentum. The deflated tire will slow the vehicle.



## SECTION 2 – SAFETY AND PRECAUTIONS

---

- If you must change lanes to get to a safe stopping place, use your signals to warn other motorists and change lanes smoothly and carefully after you are certain the lane is clear.
- Let the vehicle coast to a stop, gently steering to a safe stopping place off the traffic lanes of the road. Do not worry about damaging the tire or wheel rim by driving on it. A tire or wheel replacement is cheaper than damaging the vehicle or injuring yourself.
- When you have come to a stop, activate your hazard flashers to warn other motorists, then exit the vehicle carefully.
- Set out flares or other warning devices.

Check your tires for proper inflation before each trip and at least once a month with an accurate tire gauge.

### Recovery Towing

When calling a professional towing service, we recommend that you advise them of your motorhome length and approximate front axle weight listed on your Vehicle Certification Label. This will allow the towing operator to determine the proper towing equipment to use.

Winnebago Industries® does not assume responsibility for damage incurred while towing this vehicle.

*NOTE: Consult your chassis manual for towing instructions or precautions provided by the chassis manufacturer.*

### NOTICE

Do not lift on bumper. Damage will result to front end body parts.



### WARNING

Stay out from beneath the motorhome while it is suspended by the towing assembly. Do not allow passengers to occupy a towed vehicle. Death or serious injury can result.

---

### JUMP STARTING

To jump start the engine using another vehicle or booster system, see the chassis manual for connecting jumper cables to the automotive electrical system.

### NOTICE

Do not attempt to push start this vehicle. Damage to the transmission or other parts of the vehicle will occur.

---

### ENGINE OVERHEAT

If you see or hear steam escaping from the engine compartment or have any other reason to suspect an extreme engine overheating condition, pull the vehicle over to the roadside as soon as it is safe to do so, stop the engine, and get all passengers out of the vehicle.

### NOTICE

Operating a vehicle under a severe overheating condition can result in damage to the vehicle.

For information on what to do in case of overheating, consult the chassis manual.

# SECTION 3 – DRIVING YOUR MOTORHOME

---

The information in this section refers only to features installed or adapted to the dash and driver compartment area by Winnebago Industries®. It also includes passenger seating in the living area of the motorhome.

## Further Information

See the chassis manual in your InfoCase for all original chassis related controls, instrumentation, switches, and other features. This includes items such as cruise control, climate controls, gauges, wipers, lights, front seats, and three-point safety belts, etc.

---

## SEATS – DRIVER/CO-PILOT

The driver and co-pilot seats may be independently adjusted to suit individual preference.

## Further Information

Refer to the chassis manual provided in your InfoCase for instructions on seat adjustments.

 **WARNING**

Assure seat is in its forward and locked position for travel. Do not adjust seat while vehicle is in motion. Failure to comply may result in injuries.

---

## SEAT BELTS

Seats intended for occupancy while the vehicle is in motion are equipped with seat belts for the protection of the driver and passengers.

### Lap/Shoulder Belts

The lap belts must be worn as low as possible and fit snugly across the hip area. Always sit erect and well back into the seat. To gain full protection of the safety belt, never let more than

one person use the same safety belt at any one time, and do not let the safety belts become damaged by pinching them in the doors or in the seat mechanism. After any serious accident, any seat belts which were in use at the time must be inspected and replaced if necessary.

1- Insert tab into buckle slot until it “clicks” and is locked



Seat Belt - Typical View

### To Fasten:

Be sure belt is not twisted. Grasp each part of the belt assembly and push tongue into buckle. Adjust to a snug fit by pulling the loose end away from the tongue.

### To Release:

Press button in center of buckle and slide tongue out of buckle.

## SECTION 3 – DRIVING YOUR MOTORHOME



### WARNING

Snug and low belt positions are essential. This will ensure that the force exerted by the lap belt in a collision is spread over the strong hip area and not across the abdomen, which could result in serious injury.

Only seats equipped with seat belts are to be occupied while vehicle is in motion. Swivel seats must be in the locked, forward facing position while vehicle is in motion.

Refer to the chassis manual provided in your InfoCase for instructions on proper fastening, adjustment, and releasing of lap/shoulder belts.

### Seat Belt Care and Cleaning

- Be careful not to damage the belt webbing and hardware. Take care not to pinch them in the seat or doors.
- Inspect the belts and hardware periodically. Check for cuts, frays, and loose parts. Damaged parts should be replaced. Do not remove or modify the belt system.
- Keep belts clean and dry. If the belts need cleaning, use only a mild soap and water solution. Do not use hot water. Do not use abrasive cleaners, bleach, or dyes. These products may weaken the belts.
- Replace any belt assembly that was used during a severe impact. Replace the complete assembly even if damage is not apparent.

---

---

## CHILD RESTRAINTS

### –If Equipped

A properly installed and secured child restraint system can help reduce the chance or severity of personal injury to a child in an accident or during a sudden maneuver. Children may have a greater chance of being injured in an accident if they are seated in a child restraint system which is not properly secured.

A child restraint system is designed to be secured in a vehicle seat by a lap belt or the lap belt portion of a lap-shoulder belt.

When purchasing a child restraint system, follow these guidelines:

1. Look for the label certifying that it meets all applicable safety standards.
2. Make sure that it will attach to your vehicle and restrain your child securely and conveniently so that you are able to install it correctly each time it is used.
3. Be certain that it is appropriate for the child's height, weight, and development. The instructions and/or the regulation label attached to the restraint typically provides this information.
4. Review the instructions for installation and use of the restraint. Be sure that you understand them fully and can install the restraint properly and safely in your vehicle.

### LATCH System

#### –If Equipped

The LATCH system, (lower anchors and tethers for children) Is a 3 part system that allows you to securely fasten your car seat to the motorhome without using a seat belt. There are 2 child seat anchor loops located in the seat crack. There is a tether anchor loop located on the back of the seat to attach the tether strap.

*NOTE: The LATCH system and the seat belt are each safe but they cannot be used at the same time.*

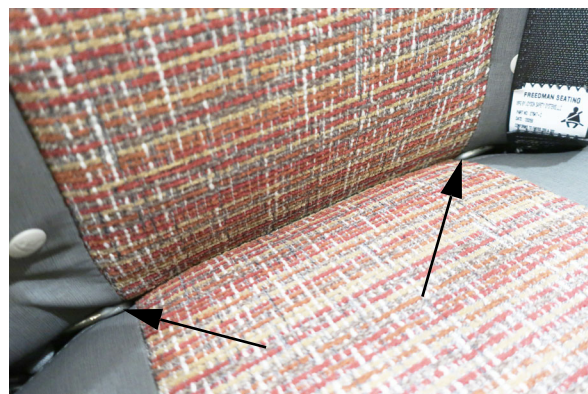

Child seat Anchor Loops  
–Typical View

1. Move the dinette table into the lowered position.
- NOTE: The dinette table must be in the down position when the child seat is in use.*
2. Set child seat upright on dinette seat.
  3. Route the tether over the top of the dinette seat back and hook it to the anchor loop (located beneath the forward facing dinette seat cushion). Pull tether strap to tighten.

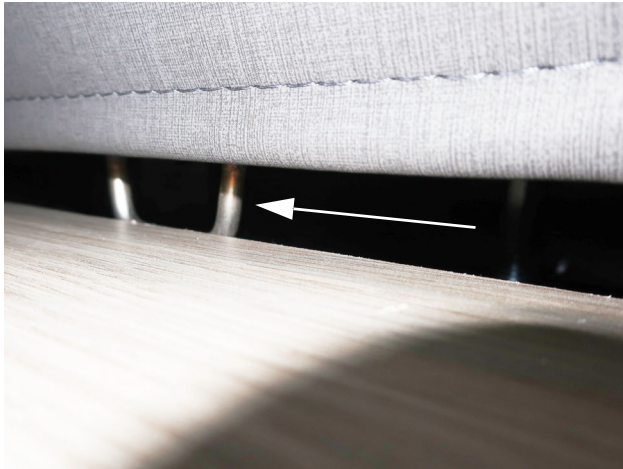

Child seat Tether loop  
-Typical View

### Further Information

See the child seat manufacturer's specific instructions for proper attachment and adjustment of the tether and seat belts.

---

---

### KEYS

Your motorhome is supplied with several keys. In addition to the chassis manufacturer's ignition key, you receive keys for the entrance door and exterior compartment doors.

Keys have an identification number, either a small metal tag or stamped into the key head. These numbers are recorded on the vehicle's component model/serial sheet, which is included in your InfoCase. In case keys are lost or stolen, your dealer or a locksmith can provide you with duplicate keys or modify the locks.

---

---

### BLIND SPOT DETECTION SYSTEM

Your motorhome is equipped with a blind spot detection system. The system consists of sensors at the rear of the vehicle to alert for obstacles such as construction barrels, lamp posts, guard rails, other vehicles, etc. There are left and right indicator lights that illuminate when there is an object in the blind spot.



Driver side blind spot indicator light.  
-Typical View



Passenger side blind spot indicator light.  
-Typical View



## SECTION 3 – DRIVING YOUR MOTORHOME

---

Severe weather or built up debris could build up on the sensors and may limit detection of objects. These sensors are located to the rear of the motorhome. **Do not** paint on or cover these locations or the sensors will not work.



Driver side blind spot sensor location. Do not paint or cover this block.  
-Typical View



Passenger side blind spot sensor location. Do not paint or cover this block.  
-Typical View



### **WARNING**

The Blind Spot Detection system should never be used as a replacement for checking the interior and exterior mirrors and looking over your shoulder before changing lanes.

### **Further Information**

Refer to the manufacturer's user guide provided in your InfoCase for further information including capabilities, and limitations of the Blind Spot Detection System.

---

### **MIRRORS – POWER EXTERIOR**

Always adjust mirrors for maximum rear visibility before traveling. Make sure the seat is adjusted for proper vehicle control and that you are sitting back squarely into the seat.

### **Further Information**

Refer to the chassis manual provided in your InfoCase for further information, including mirror adjustment and heated mirror operation.

---

### **HAZARD WARNING FLASHERS**

The hazard warning flashers provide additional safety when the vehicle must be stopped on the side of the roadway and presents a possible hazard to other motorists. When the flashers are on, it serves as a warning to other drivers.

### **Further Information**

Refer to the chassis manual provided in your InfoCase for instructions on activating, operating, and canceling hazard warning flashers.

---

---

## BATTERY BOOST SWITCH

The Battery Boost Switch can be used to draw emergency starting power from the house batteries to start the engine if the chassis battery is discharged. Alternatively, the Battery Boost Switch can be used to enable the second alternator if the lithium house batteries have reached the Reserve Voltage Cutoff or Low Voltage Cutoff (Section 6, 6-7)

To start engine due to discharged chassis battery:

1. Press and hold Battery Boost Switch.
2. Turn ignition key for emergency starting power.
3. Once engine is started release Battery Boost Switch.

*NOTE: The House/Coach Battery Disconnect switch near the entrance door must be ON and house batteries must be sufficiently charged for this feature to work.*

To Initiate charging of lithium house battery if lithium battery becomes discharged and enter Reserve Battery Cutoff or Low Voltage Cutoff:

1. Start engine
2. Press and hold Battery Boost Switch for 10 – 15 seconds to enable charging from secondary alternator.

Release Battery Boost Switch

*NOTE: The chassis battery must be sufficiently charged for this feature to work.*

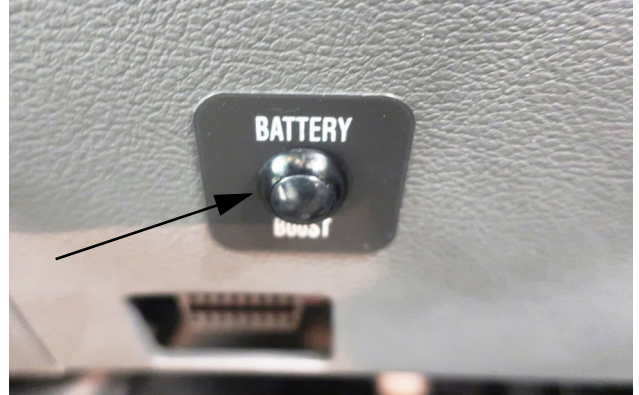

Battery Boost Switch

•If chassis battery is discharged, press and hold while turning ignition key for emergency starting power.

-Typical View

---

---

## AIR CONDITIONER/HEATER – AUTOMOTIVE (DASH)

See the chassis manual for operating information on driver and passenger comfort controls – air conditioner, heater, defroster, and ventilation.

*NOTE: The dash air conditioner is not designed to cool the entire interior of the motorhome, but is intended only to provide cooling for the cab area.*

---

---

## RADIO – IN-DASH

The radio in your vehicle is chassis-supplied. Refer to the chassis manual for complete features, programming, and operating instructions.

---

---

## REARVIEW MIRROR WITH MONITOR SYSTEM

### –If Equipped

The rearview camera in your motorhome is chassis supplied. Refer to the chassis manual for complete operating instructions.

## SECTION 3 – DRIVING YOUR MOTORHOME

---

---

---

### ENGINE COOLING SYSTEM

Do not remove the radiator cap while engine and radiator are still hot. Always check coolant level visually at the see-through coolant reservoir.

*NOTE: Your chassis engine cooling system is filled with special extended-life coolant. See the chassis manual for the correct type of coolant. The coolant system MUST be refilled or topped up with the same type of coolant as equipped to maintain the special long-life properties.*

### Further Information

Refer to the chassis manual in your InfoCase for information and precautions on filling, servicing, and checking the fluid level.

---

---

### TIRES

Improper tire pressure can result in tire overloading and abnormal wear and also affects handling, ride characteristics, and fuel economy.



### WARNING

Make sure all replacement tires are of the same size and rating as those shown on your Vehicle Certification Label.

---

---

### SUSPENSION ALIGNMENT AND TIRE BALANCE

The front suspension and steering system of this vehicle was factory aligned using highly accurate equipment prior to delivery to the dealership. However, alignment should be checked and adjusted after you have fully loaded the motorhome according to your personal needs. Thereafter, the alignment should be periodically inspected to help prevent uneven tire wear.

Any excessive or abnormal tire wear may indicate worn or misaligned suspension or steering, unbalanced tire, or other tire/suspension problem.

Alignment can be affected by worn steering/suspension parts or by incidents which happen during driving, such as hitting a curb, pothole, or railroad track, etc. Improper alignment can cause tires to roll at an angle and wear unevenly. It may also cause the vehicle to “pull” to the right or left. Have your dealer inspect your vehicle’s suspension and steering components periodically for misalignment or wear.

Out-of-balance tires will not roll smoothly and can lead to vibrations and uneven tread wear, such as cupping and flat spots. Tires may need to be balanced if uneven wear is detected or if ride comfort decreases noticeably.

### Further Information

Refer to the chassis manual provided in your InfoCase for further information.

---

---

### LIGHTS

All exterior lights should be checked for proper operation each time the vehicle is prepared for a trip. Any bulbs which fail to light should be checked and replaced, when necessary, with a new bulb of the same size. A failure of more than one light, such as both taillights not operating, may indicate a burned out fuse. Check fuse and replace with one of the same rating when necessary. If a fuse is not the cause of the problem, the wiring system should be checked immediately by an authorized service center.

### Further Information

Refer to the chassis manual in your InfoCase for further information.



## SECTION 4 – APPLIANCES AND SYSTEMS

The appliances installed in your motorhome are manufactured by reputable RV appliance makers and have been tested by independent laboratories to meet all applicable standards and codes set for RV appliances.

See *Section 2 - Safety and Precautions* of this manual for any safety and precautions you need to take regarding the operation of your appliances.

### REFRIGERATOR

The refrigerator in your motorhome can operate from either of two energy sources available to the motorhome:

- 120-Volt AC Electric-through 12V converter power
- 12-Volt DC Electric

**WARNING**

Do not let children play inside the motorhome unattended. Unlike your home refrigerator/freezer that one could push open the door from the inside, your motorhome refrigerator has a travel latch and when engaged would trap a child inside resulting in suffocation leading to death or serious injury.

### Basic Refrigerator Operation

There are 3 operation buttons on the upper portion of your refrigerator (shown in the picture). They are the **ON/OFF** button (displayed as a power icon), the **Temperature setting** button (displayed as a snowflake icon), and a **Night Mode** button (displayed as a half-moon icon).

1. **ON/OFF** button- push and hold for 2 seconds to switch on the refrigerator. After 10 seconds the Temperature setting indication will dim. The blue light indicates that the refrigerator is still in function.
2. **Temperature Setting** button- push and hold for 1 second, then tap the button again to select the desired cooling (1-5).
3. **Night Mode** button- the blue light will indicate when the night mode is active. The cooling unit will then run at low speed, reducing the noise and power consumption.

When you first use your refrigerator, turn the temperature control to “5”, the coldest setting. After 24 hours, adjust the temperature control to the setting that best suits your needs.

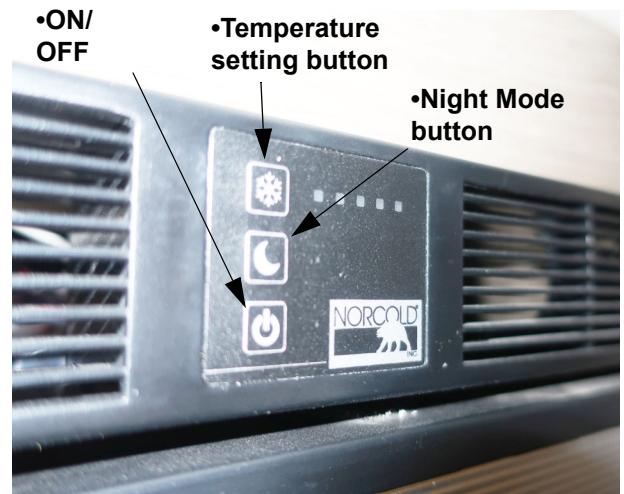

The 3 refrigerator buttons shown at the top of the refrigerator  
-Typical View

*NOTE: Allow 24 hours for your refrigerator to cool completely before storing food.*

See the manufacturer’s user guide provided in your InfoCase for information on adjusting refrigerator/freezer temperatures to best suit your needs.

## SECTION 4 – APPLIANCES AND SYSTEMS

### Further Information

Refer to the manufacturer's user guide provided in your InfoCase for complete operating instructions, safety precautions, and maintenance information.

---

---

### RANGE TOP

#### -If Equipped

*NOTE: See the appliance manufacturer's user guide provided in your InfoCase for complete operating instructions and safety precautions.*

The range in your motorhome operates on propane gas and will provide most of the functions of the range in your home.



-Typical View



### WARNING

Top cover must be open when any burner is in operation.

### To Light Range Top Burners

- Lift glass range cover.
- Push in desired control knob and turn to IGNITE position - and maintaining the knob pushed in, press down on the spark pump a few times, you will hear the igniter "click".

*NOTE: If the burner does not light within about ten seconds or if the flame should go out during cooking, turn the burner off. If gas has accumulated and a strong gas odor is detected, open a window and wait 5 minutes for the gas odor to disappear before relighting the burner.*

*If the appliance has not been operated for a period of time, the surface burner may be difficult to light due to air in the gas line.*

- To extinguish the burner flame, turn desired burner knob to OFF.

### Avoiding Asphyxiation

The following warning label has been located in the cooking area to remind you to provide an adequate supply of fresh air for combustion.



### DANGER

Do not use gas cooking appliances for comfort heating. Can lead to carbon monoxide poisoning, which can lead to death or serious injury.



### WARNING

Gas cooking appliances need fresh air for safe operation.

Before operating:

Open vents or windows slightly or turn on exhaust fan prior to using cooking appliance. Gas flames consume oxygen, which should be replaced to ensure proper combustion. Improper use can result in death or serious injury.

Unlike homes, the amount of oxygen supply is limited due to the size of the recreational vehicle, and proper ventilation when using the cooking appliances avoids dangers of asphyxiation.

It is especially important that cooking appliances not be used for comfort heating, as the danger of asphyxiation is greater when the appliance is used for long periods of time.

FAILURE TO COMPLY COULD RESULT IN DEATH OR SERIOUS INJURY.



## WARNING

Portable fuel-burning equipment including wood and charcoal grills and stoves, shall not be used inside the recreational vehicle. The use of this equipment inside the recreational vehicle can cause fires or asphyxiation. Failure to comply could result in death or serious injury.

## NOTICE

Turn off the range and allow it to cool before closing the range cover. The range cover is made of glass and may shatter when heated.

## MICROWAVE OVEN

–If Equipped

Refer to the manufacturer’s user guide located inside the appliance for complete operating instructions.

## NOTICE

Do not store items in oven. If oven would turn on stored items can ignite resulting in fire and or property damage.

## TAILGATE PACKAGE (MODEL 622A)

–If Equipped

(Typical View – Your motorhome may differ in appearance)

The tailgate package contains a refrigerator, sink and stove top for convenience outside the motorhome. The tailgate package is located on the passenger side compartment behind the main entrance door. To return the tailgate package to the storage configuration, reverse the steps shown below.

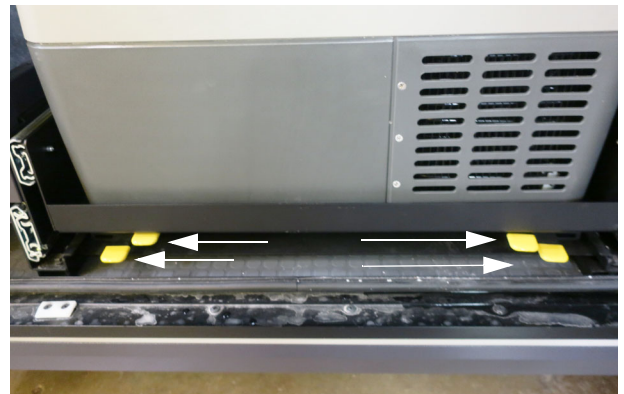

- Push the yellow tabs outward to release and slide out the tailgate package. The upper tabs release the refrigerator, while the lower tabs release the stove and sink package.

–Typical View



- Refrigerator in the extended position.

–Typical View



## SECTION 4 – APPLIANCES AND SYSTEMS

---

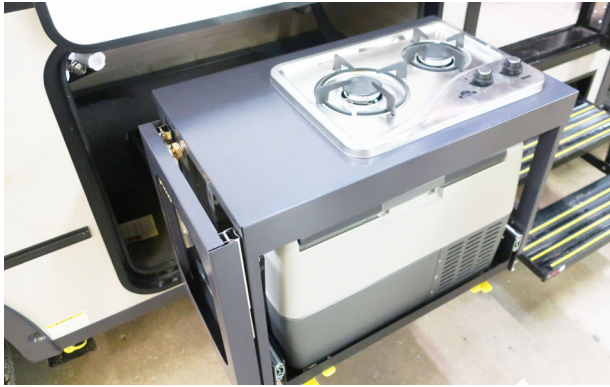

- Stove in the extended position.  
-Typical View



- To collapse the sink table, locate the metal release tab to collapse and return the sink table to the original position.  
-Typical View

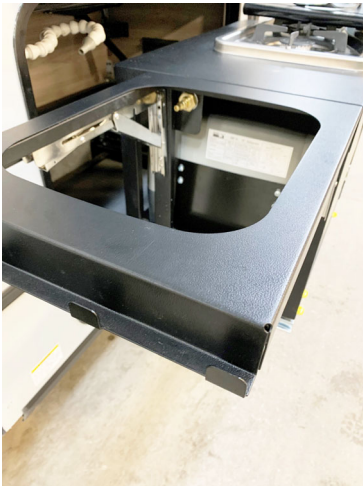

- The tailgate package also comes with a removable sink attachment. To install, lift up the sink table until it locks into place.  
-Typical View



- Pull the removable sink out of storage (shown in the collapsed storage position).  
-Typical View



- Holding the sides of the sink with your hands, push in with your thumbs to pop the sink into the use configuration.  
-Typical View

## SECTION 4 – APPLIANCES AND SYSTEMS



•The sink then inserts into the open space on the sink table.

-Typical View



•Exterior Shower/Wash Station (located in the exterior compartment.)

-Typical View



•The sink also comes with a removable water faucet that attaches to the exterior wash station located in the same compartment as the tailgate package.

-Typical View



•Faucet shown installed. The segmented faucet can be bent and turned to the desired position.

-Typical View

## SECTION 4 – APPLIANCES AND SYSTEMS



- Located under the sink table is the attachment for an LP tank that will run the stove.
- Typical View

---

---

### SYSTEMS MONITOR PANEL

The Systems Monitor Panel provides a convenient, central location for checking the condition of all utility systems in your motorhome.

From the touch screen menu, you can check the fresh water and holding tank levels, the chassis battery and coach battery conditions, start the generator or turn on the water pump. The System Monitor Panel is located on the wall next to the main entrance door.



System Monitor Panel  
-Typical View

### Freezing Temperature Warning Screen

The freezing temperature warning is displayed when the outside temperature is 40 degrees (Fahrenheit) or lower as measured in the tank pressure/temperature sensors. Once the “Ok” button is pressed, the message will not appear again for 24 hours.

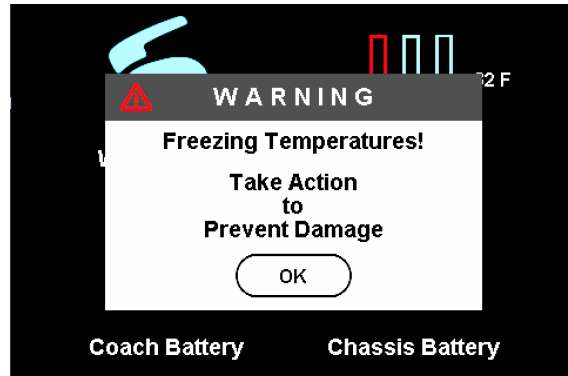

Freezing Temperature Warning  
Screen  
-Typical View

### Generator Start/Stop

See *Section 6 - Electrical* for generator start-up/shut-down and generator instructions.



Select the Generator Icon on the main menu to access the Generator start/stop screen.

-Typical View

### Water And Holding Tank Levels

Select the Tank Level icon on the main menu to view the fresh water and holding tank levels.



*NOTE: If the motorhome is not on a leveled surface or “leveled” the accuracy of the sensors can be affected. Holding tank levels reading 0-5% may indicate empty, and 95-100% may indicate full.*



Select the Tank Level icon on the main menu to view the Fresh Water and Gray tank levels screen.  
-Typical View

### **Tank Capacities**

See “Tank Capacities” in *Section 1 - Introduction*.

### **Battery Charge Meter**

Select the Coach battery icon on the main menu to check the level of charge (voltage) in the chassis and house batteries.

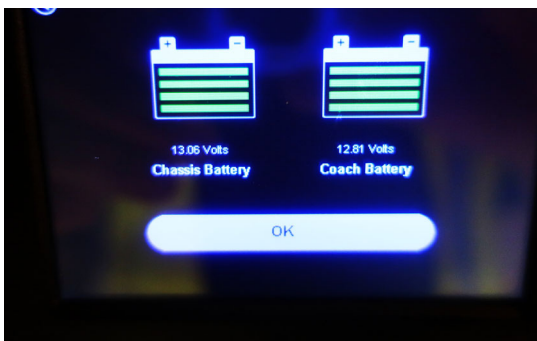

Select the Coach battery icon on the main menu to view the level of charge (voltage) of the Chassis battery and the Coach Battery.  
-Typical View

To get an accurate reading:

- Both the chassis engine and the generator engine must be shut off and 120-volt AC shoreline unplugged.
- An interior light should be turned on to provide a small load which draws off the battery surface charge.

### **Water Pump ON/OFF**

When use of the self-contained water system is desired, select the Water Pump icon from the main menu and turn the Water Pump ON. Water will be available as soon as a faucet is opened.

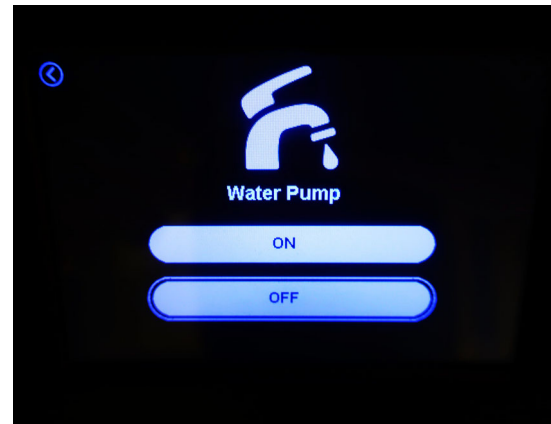

Select the Water Pump icon on the main menu to access the water pump ON/OFF button.  
-Typical View

Refer to *Section 7 - Plumbing* for additional information on the water pump and initial start-up.

*NOTE: Some models may be equipped with a Water Pump switch in the water service center on the outside of the motorhome or within the bathroom area for your convenience.*

---

### **SOLAR CHARGE PANEL**

The roof-mounted Solar Charge Panel uses the sun to help keep your house batteries charged. A Solar Charge Controller is located near the monitor panel to show you when the Solar Charge Panel is actively charging the house batteries.

## SECTION 4 – APPLIANCES AND SYSTEMS

The solar charging system installed in your motorhome has a maximum input rating of 30 Amps. Every solar panel connected to the system needs to be accounted for, this includes all roof mounted panels and the ground level single solar port.

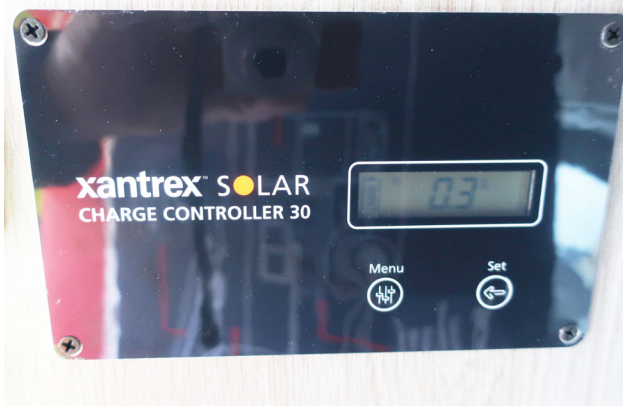

Solar Charge Controller  
(Located near the monitor panel)  
-Typical view

### Further Information

Refer to the manufacturer's user manual provided in your InfoCase for complete operating instructions.

## HEATING SYSTEM – FURNACE

The heating system in your motorhome is a propane unit that provides warm forced air for heating.

*Read the Manufacturer's Operation Manual for complete Safety Warnings, Operating Instructions, and Maintenance Information before operating the heating system.*

The control panel controls motorhome interior heating temperature.

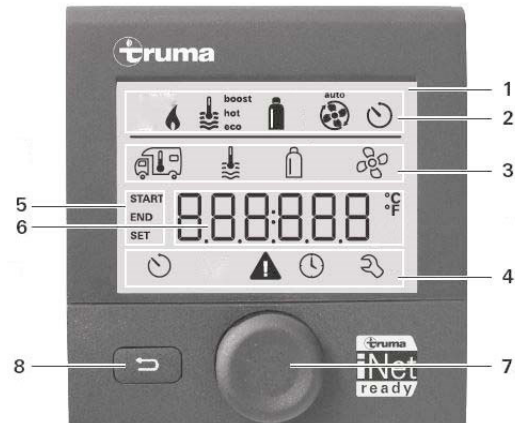

Control Panel  
(Located near monitor panel)  
-Typical View

1. Display
2. Status Line
3. Menu Line (top)
4. Menu Line (bottom)
5. Time Switch Display
6. Settings/Values
7. Rotary Push Button
8. Back Button

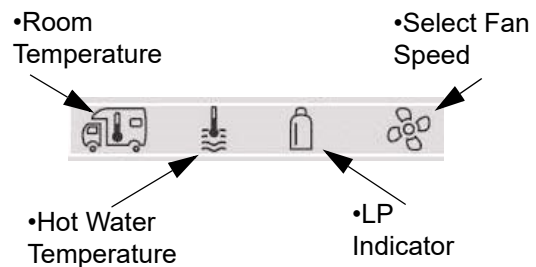

Menu Line (top)  
-Typical View

**ROTARY PUSH BUTTON:** used to select menu items and to adjust settings.

- Turn clockwise or counterclockwise to scroll through the menu.
- Turn clockwise to increase values (+) and counterclockwise to decrease values (-).



- Tap to save a selected value.
- Press for three (3) seconds to turn the control panel on/off.

**BACK BUTTON:** used to go back to the previous menu or to cancel a setting.

### Further Information

Refer to the manufacturer’s user guide provided in your InfoCase for complete operating instructions, safety precautions, troubleshooting, and maintenance information.

---

## **WATER HEATER – GAS TANKLESS WITH DECALCIFICATION**

### **–If Equipped**

The Gas Water Heater operates from propane gas. In Comfort mode, the recirculation pump inside the water heater recirculates the hot water in the lines to ensure instant hot water at any faucet. To conserve propane gas and power, choose the Economy mode.

*See the Water Heater manufacturer’s operation manual provided in your InfoCase for complete operating instructions, safety warnings, decalcification instructions, and maintenance information before operating the Water Heater.*

1. **Be sure the Water Heater is filled with water before starting the Water Heater.** To fill the Water Heater, turn the Water Pump switch ON and open water faucets anywhere in the motorhome. When water begins to flow steadily from the faucet, the Water Heater is full. Close all water faucets.
2. **Turn on the Water Heater:** Turn “ON” the Water Heater Power Switch (located behind the water heater access panel on exterior of motorhome) by pressing up or down. When the water heater is on, a green light will illuminate above the switch.

*NOTE: Both on positions on the power switch have the same function.*

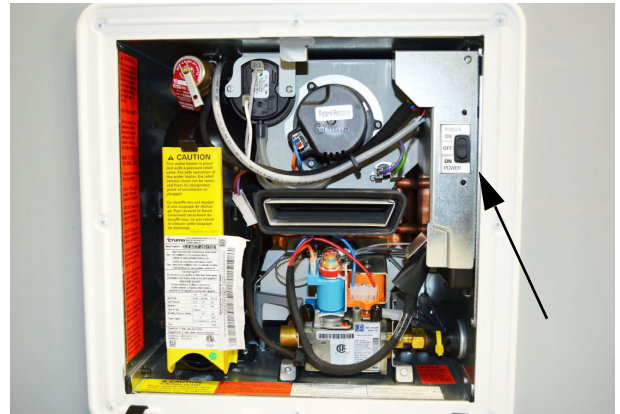

**Water Heater Power Switch**  
(Located behind water heater access panel on exterior of the motorhome)

3. **To select an operating mode,** rotate the switch (located in the lavatory) to the operating mode of your choice.

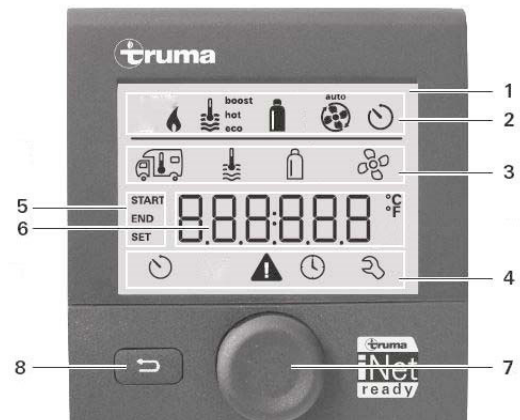

**Control Panel**  
(Located near monitor panel)  
-Typical View

1. Display
2. Status Line
3. Menu Line (top)
4. Menu Line (bottom)
5. Time Switch Display
6. Settings/Values
7. Rotary Push Button
8. Back Button

## SECTION 4 – APPLIANCES AND SYSTEMS

---

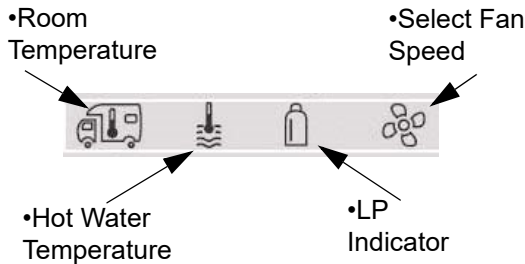

Menu Line (top)  
-Typical View

*See the Water Heater manufacturer's operation manual provided in your InfoCase for complete operating instructions.*

The AquaGo™ comfort plus is equipped with a circulation pump. The circulation pump as well as the burner are switched on automatically by the control unit in order to keep the water temperature above a certain level (102°F (39°C) in “Comfort” mode and 41°F (5°C) in “ECO” mode).

To conserve gas and power, use the “ECO” switch position. This will maintain a temperature above 41°F (5°C) in the Truma AquaGo™ instant water heater.

For maximum comfort (rapid availability of hot water at the faucet), use the “Comfort” switch position. This will maintain a temperature above 102°F (39°C) in the appliance and the hot water lines in the motorhome.

- **To turn off the Water Heater.** First turn the control panel (located in the lavatory) to the OFF position. Then turn the Water Heater Power Switch (located behind water heater access panel on exterior of the motorhome) to the OFF position.

### Decalcification

Lime scale occurs especially as a result of precipitation from “hard” water. The appliance must be decalcified regularly depending on water hardness and hot water consumption.

See the Water Heater manufacturer's operation manual provided in your InfoCase for complete decalcification instructions and frequency.

### Further Information

See the Water Heater manufacturer's operation manual provided in your InfoCase for complete operating instructions, safety warnings, decalcification instructions, and maintenance information.

---

## DUCTED ROOF AIR CONDITIONING SYSTEM

All cooling functions controlling to setpoint have a short cycle protection time delay of three minutes. There will be no delay if the cycle OFF time exceeds three minutes.



Air conditioner vent located at the rear of the motorhome.  
-Typical View

*NOTE: The ducted roof air conditioning system has ceiling registers that can be closed if necessary to force more cool air toward a specific area of the motorhome or to route cool air away from a specific area. If too many vents are closed, however, it*

*can cause the air conditioner unit to shut down, particularly in high humidity conditions.*



Air conditioner controller  
(located near the monitor panel)  
-Typical View

### **Further Information**

Refer to the manufacturer's user guide provided in your InfoCase for complete operating instructions.



## SECTION 5 – PROPANE GAS

### PROPANE GAS SUPPLY

The propane gas system supplies fuel for the gas range, water heater, and furnace. When used and handled properly, this system is safe and economical and provides modern living conveniences wherever you travel.

See *Section 2 - Safety and Precautions* in this manual for other safety and precautions you need to be aware of related to propane.

### How Propane Gas Works

Propane is a type of LP (Liquefied Petroleum) gas compressed into liquid form for easy transportation and storage. Propane gas may also be called tank gas, bottle gas, or simply LP.

Propane is used by appliances in vapor form only, but is stored in the cylinder as a liquid under very high pressure. As the liquid gas is released, it reverts back to a vapor and expands to many times its compressed volume.

### Propane Cylinder System

The storage reservoir for the propane gas system is located in a passenger side 2nd from the rear compartment.



### WARNING

Do not place propane cylinders inside the vehicle.

Propane cylinders are equipped with safety devices that relieve excessive pressure by discharging propane to the atmosphere.

Propane gas is highly flammable.  
Can lead to a fire or explosion and result in death or serious injury.

### LP Auto Changeover System

Turn on both LP supply cylinder valves. The indicator should be green when the cylinders are full. Check to make sure the indicator stays

green, then turn the indicator knob so the arrow points towards the tank you want to use and now the system is ready to use. When the cylinder indicator turns red, the system will begin operating from the reserve cylinder.

### To Replace the Empty Cylinder

The LP cylinder must be removed and taken to a propane dealership for filling.

1. Turn the indicator knob towards the opposite cylinder (reserve cylinder). The cylinder that was operating as the reserve is now in use. The indicator should turn green. If the indicator remains red, the reserve tank is also empty. Both cylinders will need to be changed.
2. To change a cylinder, close the LP supply valve on the empty cylinder and remove LP hose from cylinder.
3. Remove wing nut and hold down bar to remove empty cylinder.
4. Connect the full cylinder. Reattach wing nut and hold down bar. *Be sure to properly tighten hold down brackets.* Ensure the connections are properly tightened.
5. Open the LP supply valve and check for leaks.
6. The system is now ready to use.

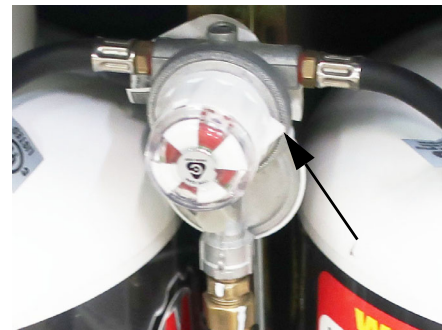

Pressure Regulator Indicator Arrow  
-Typical View

## SECTION 5 – PROPANE GAS

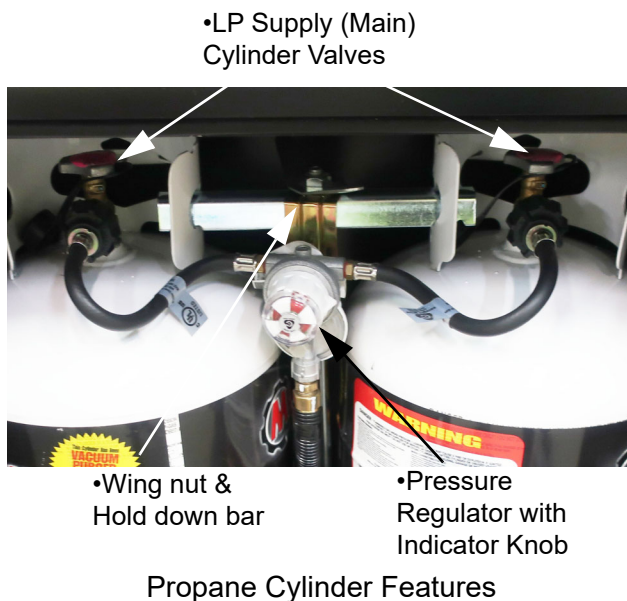

*NOTE: Be sure to properly tighten hold down brackets.*

-Typical View



### WARNING

Do not fill propane container(s) to more than 80 percent of capacity. A properly filled container contains approximately 80 percent of its volume as liquid propane. Overfilling propane container(s) can result in uncontrolled propane flow, which could lead to a fire or explosion and result in death or serious injury.



### DANGER

All pilot lights, appliances, and their igniters (see operating instructions) shall be turned off before refueling of motor fuel tanks and/or propane containers. Can cause ignition of flammable vapors, which can lead to a fire or explosion and result in death or serious injury.



### WARNING

This propane piping system is designed for use with propane only. Do not connect natural gas to this system. Securely cap inlet when not connected for use. After turning on propane, except after normal cylinder replacement, test propane piping and connections to appliances for leakage with soapy water or bubble solution. Do not use products that contain ammonia or chlorine to test for leaks. Can lead to a fire or explosion, which could result in death or serious injury.

### Selecting Propane Fuel Types

We recommend using straight propane in your propane cylinder. Propane gas is commonly available at all propane gas outlets in the U.S. (According to the National Propane Gas Association, propane gas outlets in the United States do not offer any other type of liquefied petroleum gas than propane to the general public.) Check local phone directory yellow pages for locations of local propane gas refilling stations or bulk dealerships.

*NOTE: If you travel outside the U.S. with your motorhome, you may find butane or propane/butane mixtures available in addition to propane. Because gas-burning RV appliances are designed to run on propane only, we recommend that you request straight propane only. Butane burns about 30 percent hotter than propane and can overheat some appliances, particularly refrigerators, and cause permanent damage. Other appliances designed to operate on propane can become sooted and lose efficiency by using butane fuel.*



## **Air in the Propane Gas Cylinder**

If your gas appliances do not stay lit or require frequent adjustment, even though you know the propane cylinder contains sufficient fuel, the problem may be air in the propane gas cylinder. Air in the cylinder mixes with the propane gas vapors causing them to burn poorly. This condition could linger for weeks if the air is not purged from the cylinder. Most propane gas dealers have equipment for purging air from propane gas cylinders and will purge before refilling the cylinder.

## **LP Quick Connect Port**

The LP Quick Connect Port is located on the passenger side for convenience.



LP Quick Connect Port (shown closed).  
Located on the passenger side.  
-Typical View



LP Quick Connect Port (shown open).  
Located on the passenger side.  
-Typical View

## **SAFE USE OF THE PROPANE GAS SYSTEM**

The propane system is designed and built with strict adherence to national, state, and recreational vehicle industry requirements for mobile propane gas equipment.

For your safety, there are many safety devices and backup systems installed, such as fill overflow valves, an interior propane gas detector/ alarm, and an interior carbon monoxide (CO) detector/alarm.

Propane gas also contains an odor additive that you can smell if propane is present in the air.

Here are a few precautions to observe that will help you to use the propane gas system safely:

- Exercise caution at all times. Be familiar with the distinctive odor of propane gas. If a leak is suspected, turn off the supply valve immediately. Have the propane gas system checked by your dealer or other qualified propane gas service center.
- Do not tamper with the propane gas piping system, pressure regulator, or gas appliances. Service and maintenance of propane gas system components should be performed only by your dealer or a qualified propane gas service center.
- Never attempt to connect natural gas to the propane gas system.
- Have the entire propane gas system inspected for possible leaks and missing or damaged parts at each filling. Also inspect before and after each trip, and any time trouble is suspected.
- Turn the propane supply valve off when not using the propane gas system.
- Never use a wrench to tighten the supply valve. It is designed to close leak-tight by hand. If a wrench is required to completely close the valve, it is defective and must be replaced.
- Be sure appliance and outside vents are open and free from obstruction when using the propane gas system.

## SECTION 5 – PROPANE GAS

- Never attach a lock or any device requiring a key to the propane compartment door. According to standards set for recreation vehicles, the propane supply valve must be readily accessible in an emergency.
- Exercise caution when drilling holes or attaching objects to the walls. Gas lines and electrical wiring could be seriously damaged and present an extreme safety hazard.

---

---

### PROPANE GAS WARNINGS AND PRECAUTIONS

It is illegal for vehicles equipped with propane container to travel on certain roadways or through certain tunnels in the U.S. To avoid inconvenience, check state regulations concerning flammable gas transportation.

#### Propane Gas Leaks

The following label is located in the vehicle near the range area. If you smell gas within the vehicle, quickly and carefully perform the procedures listed.



### **DANGER**

#### IF YOU SMELL PROPANE

1. Extinguish any open flames and all smoking materials.
2. Shut off the propane supply at the container valve(s) or propane supply connection.
3. Do not touch electrical switches.
4. Open doors and other ventilating openings.
5. Leave the area until odor clears.
6. Have the propane system checked and leakage source corrected before using again.

Ignition of flammable vapors could lead to a fire or explosion and result in death or serious injury.

- All pilot lights must be extinguished and appliances and their ignitors turned off while refilling the fuel tank or propane container.
- Never smoke while refilling vehicle fuel tank or propane gas container.
- Avoid inhaling exhaust gases produced by burned gasoline, diesel fuel, or propane gas in items such as the range, chassis engine, generator engine, refrigerator, furnace, and water heater. They contain carbon monoxide, which is an odorless, colorless, and poisonous gas.



### **WARNING**

Do not place propane cylinders inside the vehicle.

Propane cylinders are equipped with safety devices that relieve excessive pressure by discharging propane to the atmosphere.

Propane gas is highly flammable.  
Can lead to a fire or explosion and result in death or serious injury.

- Never use an open flame to test for propane gas leaks. Replace all protective covers and caps on propane system after filling. Make sure valve is closed and door latched securely.
- Portable fuel-burning equipment, including wood and charcoal grills and stoves, shall not be used inside the recreational vehicle. The use of this equipment inside the recreational vehicle may cause fires or asphyxiation.
- Regulators are equipped with a protective cover. Make sure that the regulator vent faces downward and that the cover is kept in place to minimize vent blockage, which could result in excessive gas pressure causing fire or explosion.

---

---

**PROPANE GAS PRESSURE  
REGULATOR – REMOVABLE LP  
TANK**

**–If Equipped**

Propane regulators must always be installed with the regulator vents facing downward. For operation, both tanks must be hooked to the regulator.

Only your dealer or a qualified propane gas service should remove the regulator cover for adjustments.

 <b>WARNING</b>
Visually inspect the pressure regulator vent periodically for blockage by accumulated debris or insect nests, etc. Vent obstruction could result in excessive pressure causing fire or explosion, which could result in death or serious injury. If an obstruction exists, have the regulator serviced by a qualified service center.

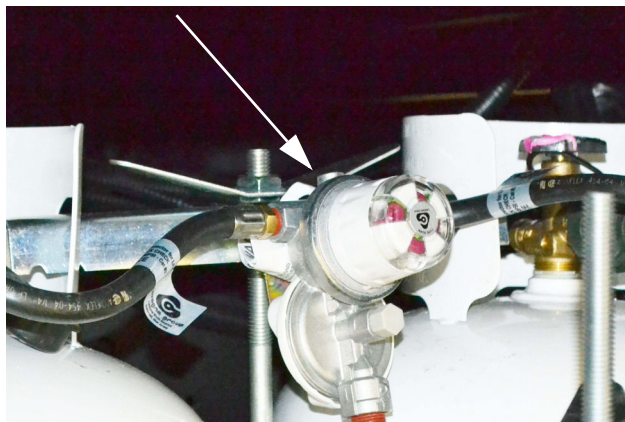

**Regulator Freeze-up**

Regulator freeze-ups are caused by the presence of moisture in fuel. This moisture will pass through the cylinder valve and into the regulator where it can freeze. Fuel producers, tank and bottle manufacturers, and propane gas dealers take every precaution to reduce moisture, but sometimes only a fraction of an ounce entering the cylinder can cause problems. To help

avoid the possibility of freeze-up, always keep control valve closed when not in use, even when cylinder is empty, to prevent moisture from collecting on the inside.

If regulator freeze-up should occur, you may attempt to thaw the regulator using a light bulb. **DO NOT USE AN OPEN FLAME OR HEAT LAMP.**

If moisture begins to cause problems, have your propane gas dealer inject a small amount of dry methyl alcohol in your cylinder (approximately one ounce to 20 pounds or one pint to 100 gallons) to help guard against regulator freeze-ups.

---

---

**PROPANE VAPORIZATION IN  
COLD WEATHER**

Propane gas vaporization increases and decreases in direct relation to ambient temperature. In other words, the lower the temperature, the slower the liquid propane will vaporize into a usable gas for appliances.

This means that in extremely cold weather when a large volume of gas is being used by the furnace for heating, it is possible to experience a loss of gas pressure.

At first, this problem may appear to be caused by an empty tank or a regulator freeze-up, but is actually caused by failure of the liquid gas to vaporize as fast as it is needed by the furnace.

The demand for propane to produce heat increases to the point where the gas cannot vaporize fast enough to keep the furnace going. The only solution to this problem is to reduce gas usage where possible.

Adjusting the temperature on the refrigerator may be a first step. Using less hot water will also help, as well as refraining from using the gas cooktop. A final step is to lower the thermostat setting to reduce gas usage by the furnace.



## SECTION 6 – ELECTRICAL

---

Your motorhome is equipped with an electrical system consisting of two separate voltages:

- 12-volt DC system (battery current); and
- 120-volt AC system (household current)

The 12-volt system consists of two internal power sources, while the 120-volt system is operated from an outside power source or the optional 120-volt generator.

---

---

### ELECTRICAL CAUTIONS

- Careless handling of electrical components can be fatal. Never touch or use electrical components or appliances while feet are bare, while hands are wet, or while standing in water or on wet ground.
- Improper grounding of the vehicle can cause personal injury. Do not plug the utility power cord into an outlet which is not grounded and do not adapt the plug to connect to a receptacle for which it is not designed.
- Do not attach an extension cord to the utility power cord.
- Be sure that all electrical appliances to be used contain 3-prong plugs for proper grounding.
- Avoid overloading electrical circuits. Replace fuses or circuit breakers with those of the same size and amperage rating only. Never use a higher rated fuse or breaker.
- Use caution when handling or working near electrical storage batteries. Always remove jewelry and wear protective clothing and eye covering. Avoid creating sparks.

---

---

### ELECTRICAL SYSTEM – HOUSE 120-VOLT AC

The 120-volt system operates from the shoreline cord connected to an outside 120-volt utility service, such as those at campgrounds or from the 120-volt generator. When the shoreline cord is connected to an outside power source, or

when the auxiliary electric generator is running, the power converter automatically changes a portion of the 120-volt current to 12-volt DC current. All equipment in the motorhome that is normally powered by the house batteries is then powered through the converter.

In addition, the following equipment is entirely dependent on 120-volt current: air conditioner, microwave oven, and any 120-volt electrical equipment used at convenience outlets.

---

---

### POWER CORD – EXTERNAL (DETACHABLE) (Shoreline)

**WARNING**

Do not use an extension cord. Improper sized cords, damaged cords, and poor connections can lead to fire, which can result in death or serious injury.

**WARNING**

Do not connect the external power cord to any receptacle until you have verified proper polarity and grounding. Be sure all prongs of the supply cord are properly plugged into the receptacle. Failure to observe can result in death or serious injury.

To connect to an external power source, plug the adapter end into the sidewall plug-in (located above the rear driver side wheel) and the receptacle end to a suitable power outlet box.

## SECTION 6 – ELECTRICAL

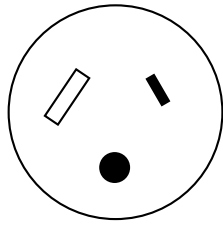

30 Amp Receptacle



### **WARNING**

This connection is for 110/125 Volt AC, 60 Hz 30 Ampere supply. Do not exceed circuit rating. Exceeding the circuit rating may cause a fire and result in death or serious injury.

The power cord is designed to ground the electrical system through the receptacle. It is also designed to carry the amperage output of most campground outlets. If the electrical receptacle to be used is designed to mate with the prongs of the power cord plug, the electrical connection can be expected to carry rated load.



Detachable Power Cord  
-Typical View



### **WARNING**

Service inlet access must be closed when utility connections are not in use.

## Park Fuses or Breakers

Most campgrounds are equipped with a fuse or circuit breaker at the receptacle (which we recommend shutting off before engaging or disengaging the power cord.) This protects the park's wiring, as well as the power cord on your vehicle from electrical damage. If electrical power fails, contact the park attendants and have them check the fuse or breaker for your supply receptacle.

## INVERTER/CHARGER UNIT – 2000W (PURE SINE WAVE) –If Equipped

The 2000-watt inverter/charger has an AC input circuit breaker to protect the inverter/charger from overloads. The inverter/charger also has “built in” features that protect the system from abnormal conditions. See the inverter/charger information included in your InfoCase for a complete explanation of the system and operating instructions.

*NOTE: Batteries may deplete quickly with use of the inverter depending on electrical loads. The inverter can also be used while driving the motorhome because the engine alternator will charge the batteries while driving.*

The inverter/charger unit is accessible through a mid-passenger side compartment door.



Inverter Charger Unit  
(Accessible through mid-passenger  
side compartment door)



**NOTICE**

Do not store items too closely around the inverter unit in the storage compartment. The inverter generates heat while operating and needs unrestricted airflow for proper cooling. Damage to the inverter can result.

The inverter converts 12-volt DC current from the house batteries into 120-volt AC current for use by 120-volt AC equipment in the motorhome.

**Charging Section**

While connected to 120-volt external power, the inverter/charger will recharge the house batteries using a 3-stage battery charger. It will also supply 12-volt DC current for use by 12-volt equipment in the motorhome.

If the house batteries have been significantly discharged, they will accept charge at a relatively high amperage rate. If they are only slightly discharged, they will charge at a lower amperage rate. The rate of charge will decrease as the batteries reach full charge, then will continue “trickle” charging at a very low amperage rate.

If the batteries do not charge as described above, it is possible the batteries are defective. If the batteries are extremely discharged, the charger may not be able to recharge the batteries.

*NOTE: Do not leave the shoreline plugged in during storage. Follow regular battery inspection and maintenance.*

**Inverter/Charger Control Panel**

The inverter/charger has a wall-mounted control panel that can be programmed for several charging options. It will also display warnings for overload conditions or other operating failure conditions.

The inverter/charger control panel is located near the monitor panel.



When the inverter/charger is not being used, it should be shut off at the charger panel. The inverter/charger could drain the house batteries if the shoreline is not connected to external power and the inverter/charger disconnect switch is on.

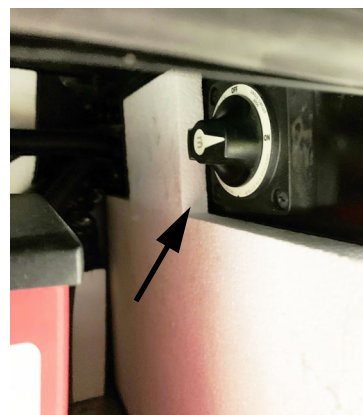

Inverter/charger disconnect switch.  
(Located inside the passengers compartment door near the Charger Unit)  
-Typical View



Inverter/charger disconnect switch.  
(Located inside the passengers compartment door near the Charger Unit)  
-Typical View

## SECTION 6 – ELECTRICAL

### Further Information

See the inverter/charger manufacturer’s user guide provided in your InfoCase for complete instructions and charging setup directions.

### CIRCUIT BREAKERS – HOUSE 120-VOLT AC

The breaker panel protects all 120-volt components in the motorhome from either an overload on the circuit or a short in the wiring or component itself. When an overload or short develops, the breaker will open preventing damage to the system.

Shut off the equipment (example: roof air conditioner) and allow a brief cooling period. Then reset the breaker by moving the switch to “Off” and back to “On”. If the breaker is continually tripped and no overload is evident, have the system checked for a short in the wiring or the appliances.



120-Volt Circuit Breakers  
-Typical View

*NOTE: Typical view of breaker panel. Breaker arrangement may vary according to appliance and equipment options. Fuses and breakers are labeled on panel.*

### ELECTRICAL OUTLETS – HOUSE 120-VOLT AC

A number of standard household electrical outlets are provided throughout the motorhome for connecting small appliances such as televisions, radios, toasters, etc.

An exterior outlet is also located on the passenger side of the motorhome.

### GROUND FAULT CIRCUIT INTERRUPTER

Bath, galley, and exterior outlets are connected to a GFCI (Ground Fault Circuit Interrupter), which is an extremely sensitive circuit breaker that will help to protect against severe electrical shock if a ground fault develops. If such a condition occurs, the GFCI will break the circuit by turning off the power to the protected outlets. Should this occur, unplug all the appliances on that circuit and press the reset button on the GFCI equipped outlet.

If the GFCI keeps tripping, have the electrical system checked and repaired, if necessary, before using again.

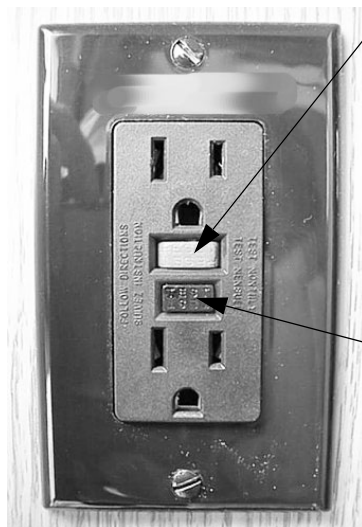

•Push to Reset circuit after monthly testing or ground fault tripping.

•Push to Test at least monthly. Should break circuit. Press Reset button to reconnect.

GFCI Outlet  
(Ground Fault Protector)

 **WARNING**

The GFCI will not completely eliminate the risk of electrical shock. Infants and small children may still be affected.

## **ELECTRICAL GENERATOR**

**-If Equipped**

 **WARNING**

Careless handling of the generator and electrical components can be fatal. Never touch electrical leads or appliances when your hands are wet, or when standing in water or on wet ground. Do not attempt to repair the generator yourself. Service should be performed by a qualified service center.

### **Automatic Power Transfer Switch**

Whenever the Generator is started, an automatic power transfer system automatically switches the household electrical system to the Generator approximately 30 seconds after the Generator is started. The 30 second delay allows the Generator to start easily without the burden of electrical loads.

### **Generator Basic Operation**

*NOTE: If the GenSet Start or Stop switch is momentarily pressed, the monitor panel will automatically try to start or stop the generator.  
Refer to the manufacturer's user guide provided in your InfoCase for additional information.*

### **To Start the Generator**

Press and Hold the GenSet Start button until you hear the Generator running smoothly, then release.

### **To Stop the Generator**

Press and Hold the GenSet Stop button until you hear the Generator come to a full stop, then release.



Generator location on the main screen of the Systems Monitor Panel  
-Typical View

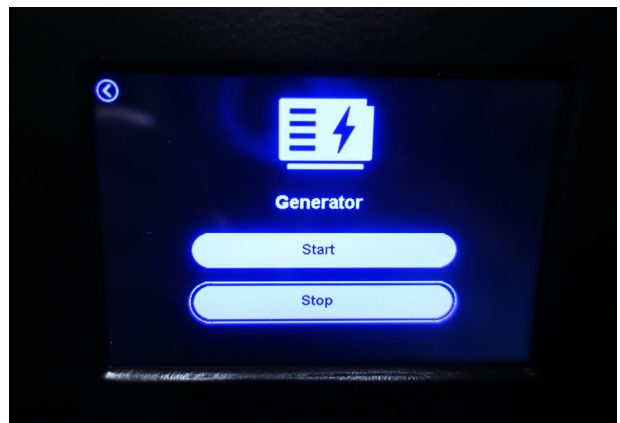

Generator Start/Stop Buttons  
(Located on the systems monitor panel)  
-Typical View

## SECTION 6 – ELECTRICAL

### Operation Warnings and Cautions



#### WARNING

The exhaust of all internal combustion engines contains carbon monoxide (CO). This poisonous gas is colorless, odorless, tasteless, and lighter than air. The exhaust systems of both your motorhome engine and your generator engine have been installed with your safety in mind. However, certain precautions must be taken when using them to protect yourself from conditions beyond the control of the manufacturer.

- Do not simultaneously operate the Generator and a power vent, which could draw exhaust gases into the vehicle.
- Do not open windows or vents on the end or side of the vehicle where exhaust pipe of the Generator is located.
- Park the vehicle so that the wind will carry the exhaust away from the vehicle. Also, note the position of other vehicles to be sure their exhaust will not enter your vehicle.
- Do not operate the Generator engine while parked if vegetation, snow, buildings, vehicles, or any other object can deflect the exhaust under or into the vehicle.

Check Generator oil level frequently during periods of use. Refer to the Generator manufacturer's user guide provided in your InfoCase for specific recommendations.

#### Further Information

Refer to the Generator manufacturer's user guide provided in your InfoCase for specific recommendations, operating instructions and cautions, troubleshooting, and maintenance.

### LITHIUM BATTERY

–If Equipped

#### Battery Specifications

##### Charge

Charging temperature range	32~113°F (0~45°C)
----------------------------	-------------------

##### Discharge

Discharging temperature range	-4~131°F (-20~55°C)-4
-------------------------------	-----------------------

##### Storage

Storage Temperature & Humidity Range	<1 Month	-4~95°F (-20~35°C) 45~75%RH
	< 3 Months	14~86°F (-10~30°C)
	Recommended storage	59~95°F (15~35°C), 45%RH
Long Term Storage	If the battery needs to be stored for >3 months the voltage should be 13.2V (50%SoC) and stored to the recommended storage specification shown above. Additionally, the battery needs at least one charge & discharge cycle every 6 months. Turn the battery off when placed into storage.	
Self-discharge rate	Residual capacity	<3% per month; <15% per year
	Reversible capacity	<1.5% per month; <8% per year

#### LED Indicator

The NeverDie® Compact Battery has a LED integrated into the power button on the unit itself. Some models may have provisions for a remote LED and power button, but their function remains the same. Refer to the table below for an explanation of the LED blink patterns.

<b>Battery State</b>	<b>LED Pattern</b>
Discharging	Solid ON
Charging	Slow Blink
Powered Off	Solid Off
Low Battery	Short Blink
Idle	Short Dual Blink
Fault Alarm	Rapid Blink

## Battery Functions

*This battery is Bluetooth compatible. Monitor battery voltage, state-of-charge, temperature, current and status code remotely from your mobile device. Download in IOS at the Apple App Store or for Android download in Google Play.*

### Reserve Voltage Cutoff (RVC)

NeverDie® function. During discharge the BMS will disable discharge current when the battery voltage reaches the RVC level, which allows the battery to store a small energy reserve. Once the battery is in the RVC state you can access the reserve capacity by a short-press of the Power button.

### Low Voltage Cutoff (LVC)

During discharge the BMS will disable discharge current when the battery voltage reaches the LVC level. Charging current is allowed, so that the battery can be charged by activating a charging source. Some charging sources require to “see” the battery voltage before allowing charging, in which case LVC lockout can be temporarily overridden by holding down the Power button. This override will allow the charger to sense the battery voltage, so charging can begin.

### High Voltage Cutoff (HVC)

During charging, the BMS will disable charge current if the battery voltage reaches the HVC voltage level. This should not happen during normal operation if charging sources are setup with correct voltage levels. Once the charge current is removed, battery voltage will slowly

lower to resting level, typically 13.6V. If your charging source has a “float” mode, it should be set to 13.6V.

### Temperature Based Cutoff

When the internal battery temperature goes below or above the preset safe limits the BMS will disable charge or discharge current to prevent further use of the battery until the temperature returns to safe operating limits. Different temperature limits are enforced for charging and discharging due to the nature of Lithium chemistry. Discharge safe range is -4°F to 131°F, charge safe range to 32°F to 113°F.

### Over Current Protection

The BMS will disable discharge or charge current if the current/ampereage value exceeds the preset thresholds. To restore normal operation, remove/address the source of the overload, then short-press the Power button.

### Short Circuit Protection

The BMS will immediately disable discharge current if the current value exceeds 1000A. To restore normal operation, remove/address the source of the short circuit, then short-press the Power button.

*NOTE: The lithium battery is capable of significant power output and may maintain the voltage level during a short circuit event, producing a very large current, capable of melting or welding connection points and damaging cables and connectors. Even when the BMS detects the short circuit and tries to open it, the BMS switch itself might weld under such large current. Make sure the battery connection is always properly fused and does not rely on the BMS alone for short circuit protection.*

### 250 Amp circuit breaker

The 250 amp circuit breaker is located in the same compartment as the batteries and inverter.

The circuit breaker is a secondary protection device that works in unison with the battery BMS.



## SECTION 6 – ELECTRICAL

---

### NOTICE

Shutting off lithium batteries or circuit breaker with engine running can result in component malfunction.

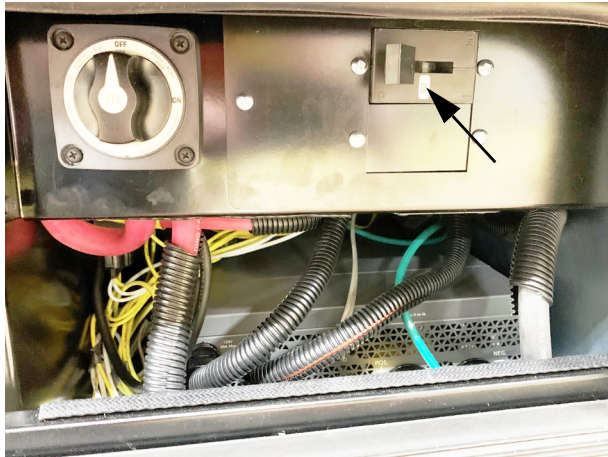

250 Amp circuit breaker  
-Typical View

### Further Information

See the lithium manufacturer's user guide provided in your InfoCase for further information.

---

## HOUSE/COACH BATTERY DISCONNECT SWITCH (COACH BATT)

The House/Coach Battery Disconnect switch lets you disconnect the house batteries from the 12-volt system of your motorhome during storage periods to avoid battery drain by electrical items that are hooked directly to the house batteries, such as clock displays and radio memories, etc.

Always leave this switch ON when the vehicle is in motion or in use.

*NOTE: Some electronic displays and memory functions may need to be reset after power has been reconnected.*

Batteries will only be charged by the converter when on shore power if the disconnect switch is ON.

*NOTE: The House/Coach Battery Disconnect Switch will illuminate green whether the disconnect switch is in the on or off position when connected to shore power.*

See also “Battery Care” elsewhere in this section.

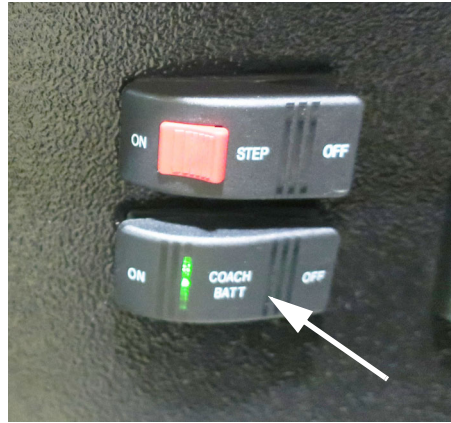

House/Coach Battery Disconnect Switch  
(Located near entrance door or end of galley, depending on model)  
-Typical View

---

## BATTERY ACCESS

The house batteries are located behind a drivers side exterior door. In order to service the batteries, the lower retention panel must be removed. It is held in place by 4 screws.



**Accessing House Batteries**

- Open battery exterior door.



Battery  
(Located inside drivers side exterior door)  
-Typical View

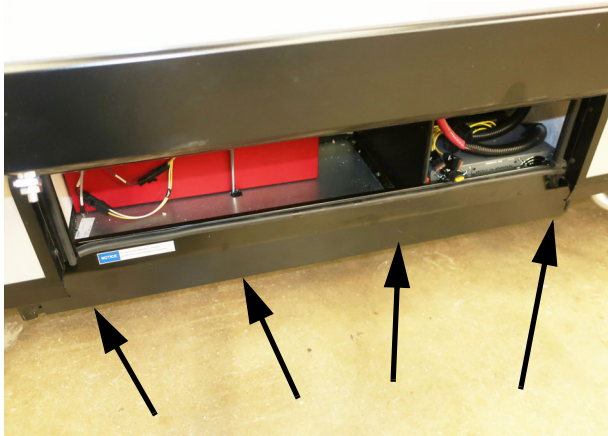

The 4 screws to remove the retention panel are located on the bottom.  
-Typical View

*NOTE: Chassis batteries are located under the driver seat.*

**NOTICE**

Always refasten battery retainers when returning a battery to the compartment.

**CIRCUIT BREAKERS AND FUSES – HOUSE 12-VOLT DC**

All 12-volt circuits and equipment in the coach area of the motorhome are protected by either a fuse panel or breaker panel. When a circuit is overloaded or a short develops in any part of the system, a fuse or breaker will shut down that circuit. If this happens, turn off all affected lights or appliances and reset the breaker or replace the fuse with a new one of equal amperage rating.

**House 12-Volt Fuses**

A label on the panel states the amperage rating and circuit protected for each fuse.

The fuse panel is located on the right-hand side of the Power Converter.



House 12-Volt Fuses  
(Located on right-hand side of Power Converter)  
-Typical View

The fuse panel accepts only blade type plug-in fuses. Always replace fuses with those of the same amperage rating.

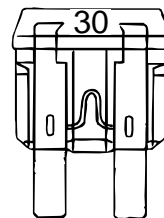

Functional

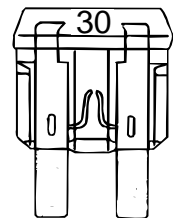

Non-Functional

## **SECTION 6 – ELECTRICAL**

---

### **Battery Charge Meter**

See related item under “Systems Monitor Panel” in *Section 4 - Appliances*.

### **Battery Boost Switch**

See *Section 3 - Driving Your Motorhome* for information on the Battery Boost switch.

# SECTION 7 – PLUMBING

## SERVICE LIGHT

For convenience a service light has been included to illuminate the Water Center Panel in low lighting conditions. The switch will illuminate when activated.

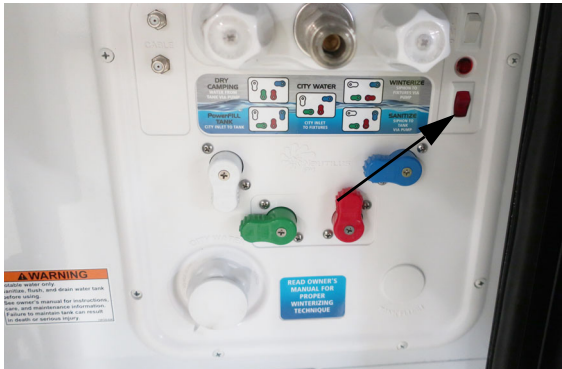

Water Center Panel service light  
-Typical View

## FRESH WATER SYSTEM

The Fresh Water System provides water to the galley sink, shower, bathroom lavatory, toilet, exterior shower, exterior entertainment center, and water heater. Water may be supplied by either of two sources:

- A fresh water tank and water pump located within the motorhome, or
- Any external fresh water source to which the motorhome may be connected, known as “city water”.

There are two ways to fill the fresh water tank on your coach - Tank Fill or Gravity Fill.

### Water Pressure Regulators

Because city water pressure varies from location to location, we recommend obtaining an in-line water pressure regulator to prevent damage to any components, connections, and seals in your fresh water system.

These devices simply connect in-line between the supply hose and the city water input on the coach. We recommend regulators that control water pressure to **50 psi. max.**

Water pressure regulators are commonly available at most RV dealerships and many large retail discount or home supply centers.

## Method 1 - Filling the Fresh Water Tank Through Tank Fill Connection

 **WARNING**

Potable water only.  
Sanitize, flush, and drain water tank before using.  
See owner's manual for instructions, care, and maintenance information.  
Failure to maintain tank can result in death or serious injury.

Always fill the fresh water tank at an approved potable water filling facility or a known purified drinking water source.

The tank is filled through the City Water Inlet located on the left sidewall.

1. Attach hose to the City Water Inlet.

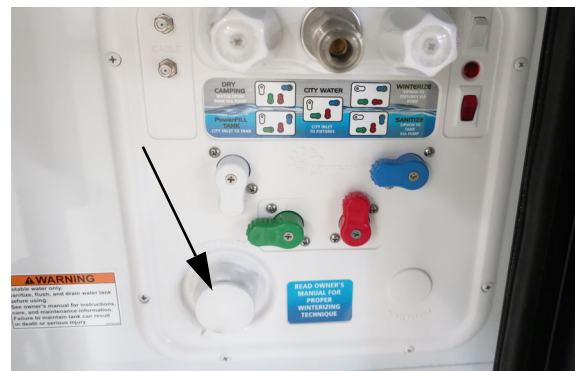

City Water Inlet  
(Located behind the drivers side service door)  
-Typical View

## SECTION 7 – PLUMBING

2. Configure the levers on the panel to reflect the “Power Fill Tank” setting as indicated by the picture instructions on the Water Center Panel.
3. Use the level display on the monitor panel to oversee filling of the tank, or when the tank is full, water will flow from tank vent tube in the service center panel.

### NOTICE

Do not leave fresh water connection unattended when filling tank. Failure to comply may result in tank expansion and property damage.

4. Turn OFF city water supply and disconnect hose from the Tank Fill Inlet.

Set the Water Panel back to the “Dry Camping” setting.

### Method 2 - Filling the Fresh Water Tank Through Gravity Fill -If Equipped



### WARNING

Potable water only.  
Sanitize, flush, and drain water tank before using.  
See owner’s manual for instructions, care, and maintenance information.  
Failure to maintain tank can result in death or serious injury.

Always fill the fresh water tank at an approved potable water filling facility or a known purified drinking water source.

The gravity tank fill tube is located in the water center on the drivers side.



Water Tank Gravity Fill  
(Located in the water center)  
-Typical View

- Insert hose into fill opening and turn water supply on. Tank is full when water flows from the tank vent tube beneath coach and out of the Gravity Fill door.

### Using Tank Water (Gravity Fill)

- Turn Water Pump switch ON. While the switch is on, the water pump will automatically supply tank water as needed.

## WATER PUMP

When your coach is not connected to a city water supply, water is supplied from the fresh water tank by a water system demand pump. A demand pump is designed to run only when you are using water. When you open a faucet, the waterline pressure drops and the pump begins to run, and it will continue to run as long as the faucet is open. When you close the faucet, the line pressure backs up to the pump, and it shuts itself off.

The pump is self-priming and will run briefly to build up line pressure when the Water Pump switch is first turned on. See “Initial Waterline Priming” for instructions on using the water system for the first time.



## Water Pump Strainer

The pump is equipped with a cleanable strainer to capture any possible tank-borne particles that could damage pump components.

*NOTE: We recommend that you check and clean the strainer after each tankful of water during the first few uses of the Water Pump system. Thereafter, remember to check it at least yearly, and be sure to empty water from it during winterization procedures.*



Water Pump Strainer  
-Typical View

## To Clean Pump Strainer

- Ensure all Water Pump switches are OFF.
- Twist the inlet cap (bowl) “counter-clockwise” to unscrew from the strainer assembly.
- Remove the bowl and pull the strainer screen out of the bowl to tap out any particles and rinse clean.
- Insert the strainer screen back into the bowl, then screw the bowl back onto the strainer assembly.

*NOTE: You must also empty the strainer when winterizing your coach to avoid water freezing and cracking the filter bowl.*

## Water Pump Switches

There are three Water Pump switches located on the top right of the Water Center Panel inside the drivers service door, inside the lavatory, or on the Systems Monitor Panel (explained in the appliance section).



Water Pump Switch on the Water Center Panel.  
-Typical View



Water Pump Switch in the lavatory.  
-Typical View

## SECTION 7 – PLUMBING

---



Water Pump Switch on the Systems Monitor Panel.  
-Typical View

While the switch is “ON”, the pump will automatically supply water as it is needed.

We recommend that you turn the Water Pump switch off whenever you will be away from the vehicle or not using the water system. In time, a slow leak in a faucet could drain the water tank, fill the holding tank, and discharge the house batteries.

### Initial Waterline Priming

1. Ensure that all water drain valves are closed, including water heater valve.
2. Turn Water Pump switch to “OFF” position.
3. Fill water tank.
4. Open all faucets, hot and cold.
5. Turn ON the Water Pump switch.
6. Close each faucet as it begins to deliver a steady stream of water (close cold water first). Leave hot water faucets on until they also deliver a steady stream of water. This will ensure that the water heater is filled with water.
7. Check to ensure the Water Pump stops soon after all faucets have been closed.
8. The Water Pump is now ready for automatic operation. The pump will start when a faucet is opened and stop when the faucet is closed.

### Water Pump Location



Water Pump  
(Located inside drivers side bed compartment  
- remove panel to access)  
-Typical View

### Further Information

Refer to the Water Pump manufacturer’s operation, care, and maintenance information provided in your InfoCase.

---

## COLD WATER FILTER

### -If Equipped

To obtain filtered cold water for drinking or cooking, simply open the galley sink cold water faucet.

*NOTE: Only the galley cold water faucet is filtered.*

The cold waterline flows through an activated carbon filter that removes chlorine and odors for taste-free drinking water.





Cold Water Filter Assembly  
(Located inside lower galley cabinet)  
**NOTE: Hot waterline is not filtered.**

## Replacing the Cold Water Filter Cartridge

You should replace the filter cartridge every season and when water flow from the faucet is too slow for convenience. The cartridge must be replaced at least every 12 months.

### Further Information

See the water filter manufacturer’s operation information in your InfoCase for filter cartridge replacement.

---

---

## DISINFECTING YOUR FRESH WATER SYSTEM

**(As required by NFPA®1192 Standard on Recreational Vehicles)**

To ensure complete disinfection of the potable water system, it is recommended that the following procedure be followed on a new system, one that has not been used for a period of time, or one that could have become contaminated.

This procedure is also recommended before long periods of storage, such as over winter.

## Disinfecting with Sanitize setting

1. Turn the levers on the Water Center Panel to the “Sanitize” position as indicated by the picture instructions on the Water Center Panel.
2. Prepare a chlorine solution using 1 gallon of water and 1/4 cup of household chlorine bleach (sodium hypochlorite solution).
3. Attach a siphon tube to the city water port and turn the pump on to siphon the chlorine solution into the tank.



Attach a siphon tube then place it in the chlorine solution container and turn the pump on to begin siphoning contents.  
(Typical View)

4. Use 1 gallon solution for each 15 gallons of tank capacity. This procedure will result in a residual chlorine concentration of 50 ppm in the water system.

*NOTE: If a 100 ppm concentration is desired, use 1/2 cup of household bleach with 1 gallon of water to prepare the chlorine solution. One gallon of this solution should be used for each 15 gallons of tank capacity.*



## **WARNING**

Chlorine is poisonous. Do not misuse. Recap bottle and clean all utensils after use.

## SECTION 7 – PLUMBING

---

5. Complete filling of tank with fresh water.
6. Turn off water heater and allow to cool.  
See the water heater in *Section 4 - Appliances and Systems*.
7. Set the Water Center Panel to “dry camping” as indicated by the picture instructions on the water center panel.
8. Open all fixtures and drain valves in the motorhome and run the water until a distinct odor of chlorine can be detected in the water discharged. Do not forget the hot water faucets. Close each fixture when done.
9. Let the system stand at least 4 hours when disinfecting with 50 ppm residual chlorine. *(If a shorter time period is desired, then a 100 ppm chlorine concentration should be allowed to stand in the system for at least 1 hour).*
10. Drain the water tank and refill with fresh water.
11. Open each fixture and drain valve again and run fresh water to flush chlorinated water from the lines. Run the water until there is no odor of chlorine detected in the water discharged. Do not forget the hot water faucets. Close each fixture when done.  
*(You may need to leave a hot water faucet open for some time to flush the water heater with clean water. You may also want to turn the water heater off until this is done to avoid wasting energy trying to heat “unused” water).*
12. Water system is now disinfected.

### Disinfecting with Tank Fill

When disinfecting through the tank water fill, an external cartridge-type water filter assembly must be connected in-line between the city water hose and the tank fill inlet to add disinfecting solution to the tank. These filters are commonly available at most RV supply stores.

*NOTE: If you do not have an in-line cartridge filter, see City Water Hose/Tank Disinfection following this procedure for an alternate method of adding bleach solution to your tank.*

1. Turn off water heater and allow to cool.  
See the water heater in *Section 4 - Appliances and Systems*.
2. Turn the water center panel to the “winterize” setting as indicated by the instructions on the water center panel.
3. Remove the filter cartridge and pour 1/4 cup of household chlorine bleach (sodium hypochlorite solution) for each 15 gallons of tank capacity into the empty filter canister, then screw the canister back onto the filter base.



### WARNING

Chlorine is poisonous. Do not misuse. Recap bottle and clean all utensils after use.

This solution will result in a residual chlorine concentration of approximately 50 ppm in the water system. *(If a 100 ppm concentration is desired, use 1/2 cup of household bleach for each 15 gallons of tank capacity).* The bleach will be drawn into the tank when the city water is turned on.

4. Fill the tank completely, then open each faucet in the motorhome and run the water until a distinct odor of chlorine can be detected in the water discharged. Do not forget the hot water faucets.
5. Let the system stand at least 4 hours when disinfecting with 50 ppm residual chlorine. *(If a shorter time period is desired, then 100 ppm chlorine concentration should be allowed to stand in the system for at least 1 hour).*
6. Drain the fresh water tank.
7. Install the filter cartridge into the filter canister, then refill the tank with fresh water.
8. Open each faucet again and run fresh water to flush chlorinated water from the lines. Run the water until there is no odor of chlorine detected in the water discharged. Do not forget the hot water faucets.  
*(You may need to leave a hot water faucet*

*open for some time to flush the water heater with clean water. You may also want to turn the water heater off until this is done to avoid wasting energy trying to heat “unused” water).*

9. Water system is now disinfected.

### **City Water Hose/Tank Disinfection**

As an alternative way to disinfect your tank, connect a city water hose to your motorhome and pour the bleach into the other end of the hose using a funnel. Hold the hose upright to avoid draining the bleach.

Connect the hose to a city water hydrant to force the bleach into the tank and fill the tank with water.

This method has the additional benefit of disinfecting the city water hose at the same time.

### **Continuous Tank Disinfection (Superchlorination)**

Some RVers like to ensure continuous sanitation of their fresh water tank by “superchlorination”– maintaining an effective low level of chlorine in the tank at all times.

- Add 1 teaspoon of household chlorine bleach (sodium hypochlorite) to your tank for each 10 gallons of tank capacity. When you fill the tank, this will result in a 6.7 ppm level of chlorine, which should kill harmful bacteria and slime-forming organisms.
- Chlorine may be removed from drinking water by the cold water filter at the galley faucet (if equipped) or by installing an activated carbon water purifier at the galley sink cold water line or a separate drinking water faucet with filter.
- Superchlorination does not affect city water usage, only the fresh water tank.

---

---

### **SHOWER HOSE VACUUM BREAKER**

After using the shower, you may notice water dripping from the shower faucet assembly. The dripping results when vacuum in the shower hose (after closing the shower faucet) slowly releases

and allows water remaining in the hose to drain down. This is a normal function of the shower valve assembly and is not a leak or defect.

If items are placed into the shower tub before shower valve vacuum release is complete, they may become wet.

---

---

### **EXTERIOR SHOWER/WASH STATIONS**

The exterior wash station features allows you to do things such as rinse off sand or salt after a swim, rinse off muddy boots, or bathe your pet outside the motorhome. The water pump switch is located in the water center panel, inside the rear passenger door.

The shower/wash stations includes hot and cold water (located inside the passenger side door).



Exterior Shower/Wash Station  
(located in the drivers side service center,  
shown with shower hose hooked up.  
-Typical View)

## SECTION 7 – PLUMBING

---



Exterior Shower/Wash Station  
(located in the exterior kitchen  
compartment.)  
-Typical View



-Typical View

To open the waste holding tank compartment, use the key (located on key ring) to unlock the compartment door then push both buttons in at the same time while pulling the door open.

---

## TOILET

### -If Equipped

*NOTE: See the toilet manufacturer's user guide provided in your InfoCase for complete operating instructions, care and cleaning instructions, and safety precautions.*

The toilet in your motorhome has a waste holding tank, which you need to empty when full. The waste holding tank is located in the left sidewall compartment.

*See "Before Use" in the toilet manufacturer's user guide provided in your InfoCase for complete instructions before using the toilet.*

When the Level Indication slide turns from green to red, the waste holding tank is full.

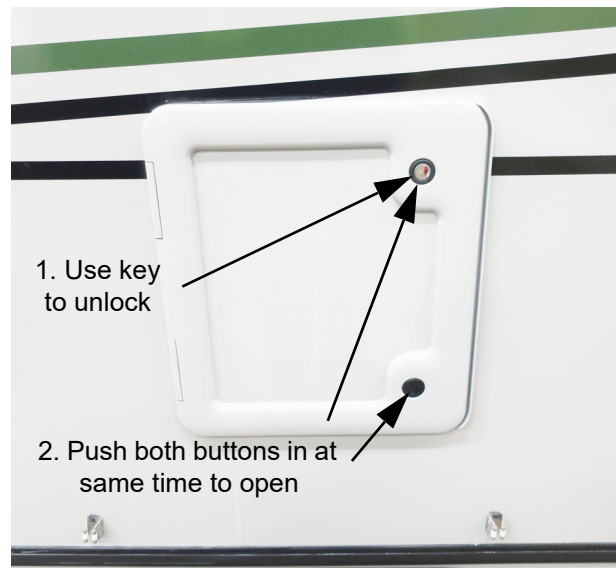

Waste Holding Tank Compartment  
(Located on left sidewall)  
- Typical View

*See the toilet manufacturer's user guide provided in your InfoCase for complete instructions on emptying the waste holding tank.*

### Important "Don'ts"

- Don't use facial tissue or regular toilet tissue in the RV toilet. These will not disintegrate sufficiently and will often cling to the sides of

the holding tank. Toilet tissue made specifically for use in RV toilets and holding tanks is available at most RV supply centers.

- Don't dispose of sanitary napkins or other non-dissolving items in the toilet.
- Don't put automotive antifreeze or caustic chemicals, such as laundry bleach or heavy detergents into the toilet or holding tank. These products may damage plastic or rubber parts in the system.

See winterizing instructions at the end of this section to prepare the toilet for storage in freezing conditions.

### **Further Information**

See the toilet manufacturer's operation information in your InfoCase for complete operating, care, and maintenance information.

---

---

## **WASTE WATER SYSTEM (MODEL 622A)**

### **(Holding Tank)**

The drainage system is self-contained and uses a holding tank to contain the waste water until it can be dumped at an appropriate waste water disposal site. This means you can use the sinks and shower even in areas where utility hookups are not available.

The gray water holding tank contains the waste water from the galley sink and shower.

See "Specifications" in *Section 1 - Introduction* for tank capacities for your model.

## **Dumping Holding Tanks**



Sewage Drain outlet  
(Located inside the service  
center on the drivers side)  
-Typical View

1. Remove dust cap from sewage drain outlet and connect sewage drain hose. Be sure it is firmly attached.
2. Place the outlet end of sewage drain hose into disposal opening.
3. Open the Gray Waste Tank Drain valve. Be sure there are no sags in the hose to ensure complete drainage. Close Gray Waste Tank Drain valve as soon as tank is empty.
4. Rinse sewage drain hose thoroughly with water before stowing.

*NOTE: We recommend that you dump all holding tanks before traveling to avoid carrying unnecessary weight.*

### **CAUTION**

Keep drain valve closed to minimize the presence of sewer gases. Sewer gases can be present when RV is connected to campground sewage hookup. Can lead to illness or personal injury.



## SECTION 7 – PLUMBING

### Using On-Site Sewer Hook-Ups

The sewage drain hose may remain attached to the sewage drain outlet while the motorhome is parked and connected to an on-site sewage hook-up.



## WARNING

Service inlet access must be closed when utility connections are not in use.

When using a sewer hook-up, keep the dump valves closed until a tank becomes full or when preparing to leave the site. This keeps the solids in suspension, allowing them to be carried out with the liquids when the dump valve is opened. If the valve is left open, the liquids will drain off, leaving solids in the tank. Should this accidentally happen, disconnect the hose, fill the tank about half full with water, and drive a few miles to dislodge the solids. A few starts and stops will aid in the process. Then reconnect the hose and drain in the normal manner.

*NOTE: Always keep sewage drain outlet capped while sewage connection is not in use.*

### Holding Tank Level Indicators

See “Systems Monitor Panel” in *Section 4 - Appliances* for further information on the monitor panel and checking the tank level.

See “Specifications” in *Section 1 - Introduction* for tank capacity for your model.

---

---

## WATERLINE & TANK DRAIN VALVES

The water drain valves are used to drain water from the water tank and the water supply lines when preparing the motorhome for storage or when sanitizing the water system.

See the drain valve location chart at the end of this section for locations on your model.



Waterlines and Tank Drain Valves  
(Shown in the closed position)  
-Typical View

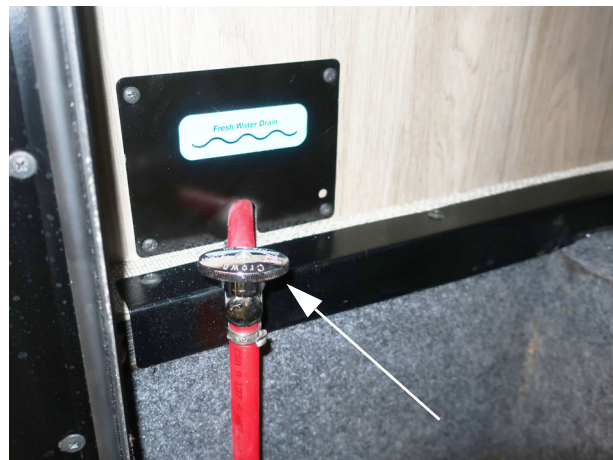

Tailgate Drain Valve (Model 622A)  
(Shown in the closed position)  
-Typical View

---

---

## WINTERIZING PROCEDURE

Your motorhome is equipped with a manually operated waterline winterization system for your convenience in winterizing fresh waterlines. This action is necessary for storage in cold climates. The winterization process blows out left over water in the pipes, and adds antifreeze to prevent pipes from freezing and bursting, possibly causing extensive damage. Blowout procedure is optional, while the anti-freeze procedure is mandatory. Certain areas of your water system require additional attention and may be required. Be sure all water is drained from the system.



*We recommend performing Step 1 “Blow Out Procedure” and Step 2 “Antifreeze Fill Procedure” to properly protect the system.*

**Step 1 – Blow Out Procedure  
(Drain and purge waterlines using compressed air)**

1. **Level the Motorhome.** If the motorhome is not level, there may be “low points” in waterlines that can trap water in the lines and prevent it from draining properly.
2. **Set the Water Center Panel to the “winterize” configuration as instructed on the water center panel.**



Water Center Panel in “Winterize” configuration (Panel located inside the service center on the drivers side).

-Typical View

3. **Turn OFF the water pump (located on the Water Center Panel at the top right of the panel).** The water pump can also be switched off at the water pump switch in the lavatory, and the water pump controls located on the Systems Monitor Panel. This switch can be turned off at any of these stations, for convenience. (The switch at the Water Center Panel will illuminate if the pump is on).



Water pump switch location on Water Center Panel.

-Typical View



Water Pump Switch in the lavatory.

-Typical View



Water pump controls location on Systems Monitor Panel

-Typical View

## SECTION 7 – PLUMBING

4. **Position the Winterization Valve 3 in the “Water Heater and Line Drain” position, and open all waterline drain valves.** (See “Water System Drain Valve Locations chart” at the end of this section for locations of drain valves on your model).

*NOTE: To make sure that all water drains properly from the water container, place a big enough vessel underneath the drainage socket of the drain valve (>2.64 gallons (10 liters)).*



Winterization Valve 3  
(Turn it to the Water Heater and Line Drain position).  
-Typical View

### **CAUTION**

Hot water can escape from the water lines causing injury. Operate drain valve only when the water line is cold.



**Waterline drain valves**  
(Shown in the closed position  
turn valves to open).  
-Typical View

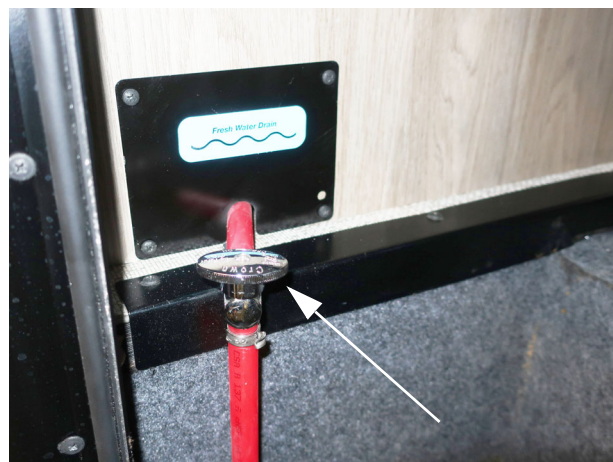

Drain the Tailgate Drain Valve  
(Shown in the closed position  
turn valve to open).  
(Model 622A)  
-Typical View

5. **Turn off the water heater in 2 locations**  
Turn off the water heater (located near the monitor panel), then turn of the water heater power switch at the water heater access panel (located behind the water heater access panel on the exterior of the motorhome). Let the water cool down before proceeding further.



**Water heater controls** located next to the bathroom door.  
-Typical View

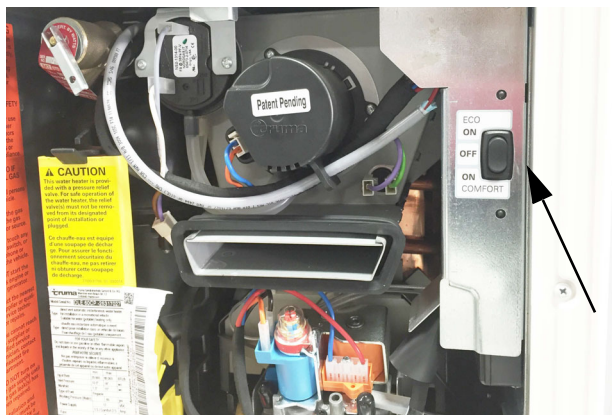

**Water Heater switch** located behind the water heater access panel of the exterior of the motor home.

To turn off water heater power switch:

- Open the access door
- Switch off the appliance at the power switch.
- Ensure the hot water has cooled down.

-Typical View

6. **Empty and clean the water pump strainer filter bowl to avoid water freezing and cracking the filter bowl** (located in the

drivers side bed compartment). Check to verify that the O-ring is in good condition and properly seated.



- To access the water pump strainer, first locate the hole in the passenger side bed lower forward storage area.
- Typical View



- Lift up on the access panel to expose the water pump.
- Typical View



## SECTION 7 – PLUMBING

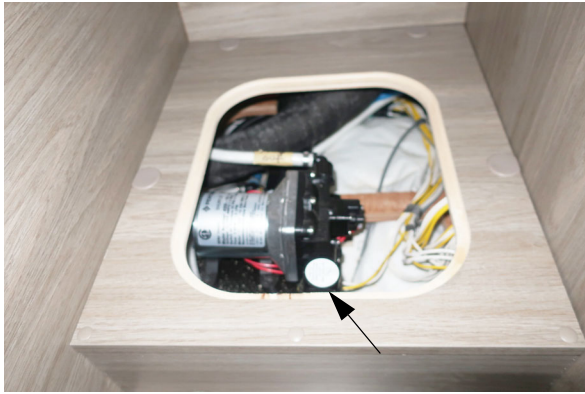

- The water pump strainer is located closest to the inside  
-Typical View



### To Clean Pump Strainer

- Twist the inlet cap (bowl) “counter-clockwise” to unscrew from the strainer assembly.
  - Remove the bowl and pull the strainer screen out of the bowl to tap out any particles and rinse clean.
  - Insert the strainer screen back into the bowl, then screw the bowl back onto the strainer assembly.
- Typical View

7. **Cold Water Filter:** Remove the filter canister from the Cold Water Filtration System under the galley sink and discard the filter cartridge.

After emptying the canister, remount it onto the filter assembly and continue the Blow-Out Procedure.



8. **Drain Water Heater (Tankless):** Open the latch with your thumb while pulling the Easy Drain Lever down as far as it will go.

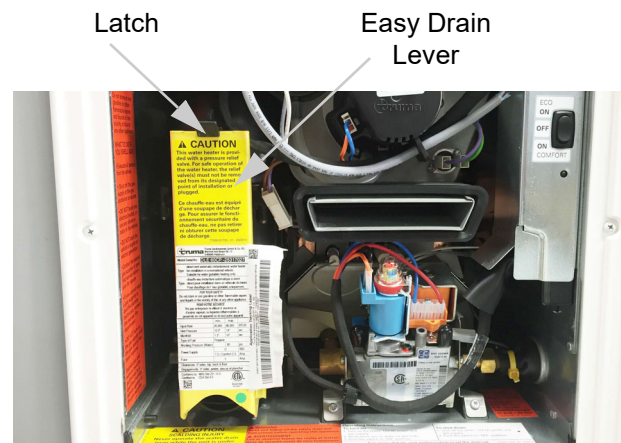

Easy Drain Lever  
(Located behind water heater access panel on exterior of the motorhome)  
-Typical View

## CAUTION

Hot water can escape from tank causing injury. Operate drain valve only when the tank water is cold.

*NOTE: See the tankless water heater operator’s manual located in your InfoCase for additional draining procedures.*



Water heater Easy Drain Lever in lowered position.  
-Typical View

9. Remove the water inlet filter and clean with clean water. The water heater will start to drain. Leave the water filter out until told to reinsert the filter.



Water inlet filter pulled out and removed.  
-Typical View

10. Set the Water Center Panel to the “blow out” configuration as seen below. (white down, red green and blue are sideways).



Water Center Panel shown in the “blow out” configuration.  
-Typical View

11. Position the Winterization Valve 3 in the “Line Drain” position and close all waterline drain valves. (See the “Water System Drain Valve locations” chart at the end of the section for locations of drain valves on your model).

*Note: If not doing the blowout procedure, skip to antifreeze fill procedure steps.*



Winterization valve in the “Line drain” position.  
-Typical View

12. **Connect Air Pressure.** Connect a “blow-out” plug to the city water inlet (located on the lower left of the Water Center Panel). Then, use a compressed air hose regulated to 30 psi or less to force air through the system. A “blow-out” plug can be purchased at any Winnebago Industries® dealer.

## SECTION 7 – PLUMBING

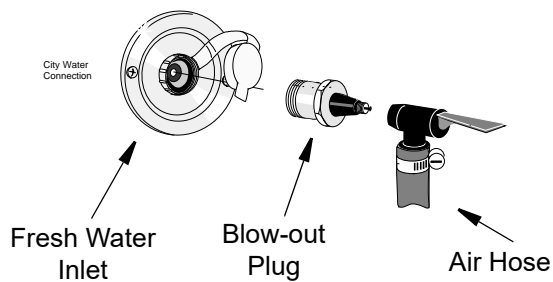

### NOTICE

Limit air pressure to 30 psi to avoid damage to equipment.

*NOTE: DO NOT burst air into the system. This can damage the water pump. It is better to let air in slowly.*

#### 13. Blow-out Exterior Shower/Wash Station at the Water Center Panel.

Attach exterior shower hose, then point shower hose toward ground and squeeze handle. Open the shower to cold water until no water continues to flow. Then repeat for the hot water.



Connect shower hose to Water Center Panel faucet (Located inside the service compartment), then squeeze handle until water stops flowing. Do this for the exterior wash station located in the exterior kitchen compartment also.

-Typical View

14. **Blow-out Lavatory Sink.** Open the faucet to cold water until no water continues to flow. Then repeat for the hot water. Shut off before moving on.



Bathroom sink Model 622A shown.  
-Typical View

15. **Blow-out Lavatory Shower.** Open the shower to cold water until no water continues to flow. Then repeat for the hot water. Shut off before moving on.



Point shower head at the drain and squeeze until water stops flowing.  
-Typical View



16. **Blow-out Toilet.** Press the toilet flush button and hold until water stops flowing in the toilet.



Toilet flush button. Hold until water stops flowing. Model 622A shown.  
-Typical View

17. **Blow-out the galley sink.** Open the faucet to cold water until no water continues to flow. Then repeat for the hot water. Shut off before moving on.
18. **Blow-out the exterior entertainment center.** Open the shower to cold water until no water continues to flow. Then repeat for the hot water. Shut off before moving on.
19. **Open all waterline drain valves minus the Cold water supply line for the water heater shown in the next pictures.** Closing each valve after no water is draining through the drain port.



Open the Waterlines and Tank Drain Valves indicated by the arrows.  
(Shown in the closed position)  
-Typical View

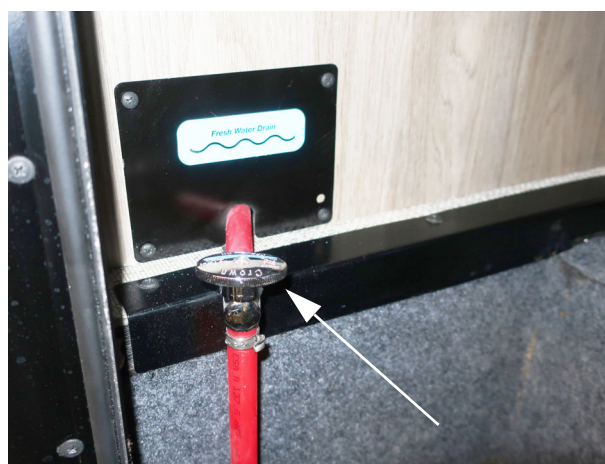

Open the Tailgate Drain Valve (Model 622A)  
(Shown in the closed position)  
-Typical View

*NOTE: The blowout procedure will not blow out waterlines leading to or from the water heater or water pump.*

20. **Turn air pressure off.** Disconnect blow-out plug when no water is draining through the valve anymore.

## SECTION 7 – PLUMBING

21. Turn Winterization Valve 3 to “Water Heater & Line Drain” position to allow water to drain from the recirculation line.



22. Close all waterline and tank drain valves, and all faucets.
23. Close the water heater drain lever with the filter installed.
24. Remove the cold-water filter canister and dump the water. Remount the canister.

### Step 2 – Antifreeze Fill Procedure (Fill plumbing lines with RV water system antifreeze)

*NOTE: Non-Toxic RV water system antifreeze is available from your dealer and from most RV supply stores and national retail outlets. Follow directions on the container to determine the correct amount to use for your motorhome.*



### **WARNING**

NEVER use automotive antifreeze/coolant in your RV water system. Automotive coolant/antifreeze contains ethylene glycol which, if ingested, can cause blindness and can be fatal.

25. Set the water control panel to the “Winterization” configuration as shown on the panel.



Winterization configuration  
-Typical View

26. Place the Winterization Valve 3 into the “Normal” position.



Place the Winterization Valve 3  
into the “Normal” position.  
-Typical View

27. Attach antifreeze siphon tube on the Water Center Panel.



Antifreeze Siphon Tube  
attached to the tank fill inlet  
-Typical View

28. Insert the end of the siphon tube into a pail or other container with 2 to 3 gallons of non-toxic RV antifreeze solution.

*NOTE: Ensure that all drain valves are CLOSED before pumping RV antifreeze into the water system. Refer to the “Water System Drain Valve Locations” chart at the end of this section for valve locations on your model.*

*NOTE: Ensure the cold water filter has been removed with the water dumped out of the filter canister and the canister has been removed.*

### Fill Lines

29. Turn the Water Pump switch ON.
30. Open each hot and cold water faucet handle/knob in the motorhome to hot until antifreeze solution just begins to flow from the faucet, then turn to cold water. Wait for the antifreeze solution to come out then shut off the faucets. Start with the galley faucet, then the lavatory faucet, then the shower.
31. Press the toilet flush button and hold until antifreeze begins flowing into the toilet. Leave a small amount of antifreeze that remains in the bowl.

32. With the Exterior Kitchen station hose connected, point hose toward the ground and squeeze handle until antifreeze solution begins to flow, then disconnect hose. Turn to hot, then to cold, then shut off.
33. With the exterior shower/wash station hose connected, point hose toward the ground and squeeze handle until antifreeze solution begins to flow, then disconnect hose. Turn to hot, then to cold, then shut off.
34. One at a time, open the waterline drain valves. Close each valve after antifreeze begins to flow through the valve. Use a bucket to catch all of the antifreeze.
35. Change the Water Center Panel to the “Sanitize” configuration as shown below.



Sanitize configuration  
-Typical View

36. Open the freshwater tank drain valve and wait for antifreeze to flow through the valve then close. Use a bucket to catch the antifreeze.

*NOTE: Antifreeze will drain outside of the coach during this step.*

### When Done Adding RV Antifreeze

37. Turn Water Pump switch OFF.
38. Turn Winterization Valve 3 to the “Water Heater and Line Drain” position to allow water and antifreeze to flow through the recirculation line.



## SECTION 7 – PLUMBING

*Note: antifreeze will drain outside of the coach during this step.*



Winterization Valve 3 turned to the “Water Heater and Line Drain” position.  
-Typical View

39. Disconnect antifreeze siphon tube.

40. **Drain Water Heater (Tankless):** Double check the water heater to make sure it is still in the “Off” position.

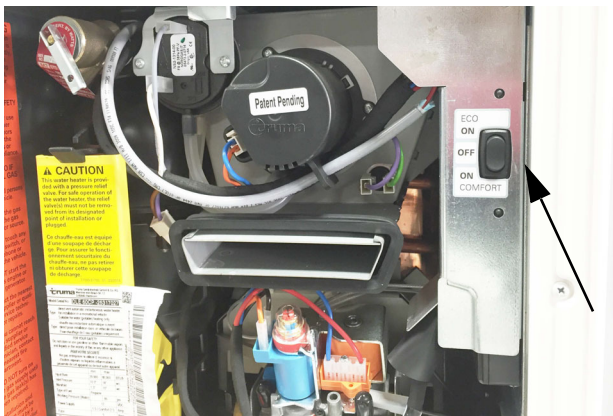

Water Heater Power Switch  
(Located behind water heater access panel on exterior of the motorhome)  
-Typical View

41. Open the latch with your thumb while pulling the Easy Drain Lever down as far as it will go.

42. Remove the water inlet filter and clean with clean water. Do not reinstall the water inlet filter until you are ready to bring the motorhome out of storage.

43. Close the water heater.

44. **Turn Winterization Valve 3** back to the “Normal” position before moving on to the next step.



Winterization Valve 3 turned to the “Normal” position.  
-Typical View

45. Leave the Water Center Panel in the “45 degree” configuration until you are ready to bring the motorhome out of storage.



Winterization 3 configuration  
-Typical View

### **Dump and Clean Holding Tanks and Cassette Toilet**

46. Completely drain the waste water holding tanks and the cassette toilet at an approved waste disposal site.

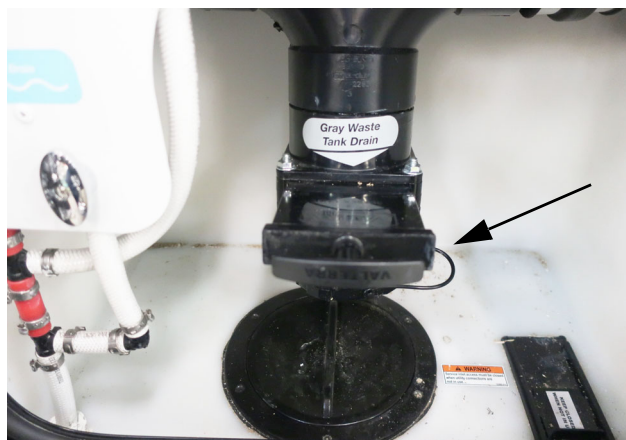

Sewage Drain Outlet with drain valve  
(Located inside the service center on the  
drivers side pull valve outward to open)  
- Model 622A shown

47. Close waste tank drain valve and refit the dust cap onto the sewage drain outlet. This will inhibit rust from forming on the valve shafts and prevent entry and contamination by airborne debris, insects, and rodents.

### **Fill Drainage System P-Trap and Pump**

48. Empty cold water filter canister under the galley sink and dump the antifreeze down the galley sink drain. Empty the water pump strainer into the galley sink.
49. Pour 4 cups (1 quart) of RV antifreeze down the lavatory sink drain.
50. Pour 4 cups (1 quart) of RV antifreeze down the shower drain to winterize the shower pump.

*Your drainage and fresh water systems are now winterized.*

*See instructions for removal from storage in Section 11 - Maintenance and Storage.*



**SECTION 7 –  
PLUMBING**

---

<b>WATER SYSTEM DRAIN VALVE LOCATIONS</b>		
<b>MODEL</b>	<b>SYSTEM</b>	<b>DRAIN VALVE LOCATIONS</b>
<b>622A</b>	<b>Waterline Drain Valves</b>	<ul style="list-style-type: none"> <li>• Three (3) valves located inside the Water Service Center on the drivers side. <i>Also, place the tip of your finger inside the city water connection and gently press the backflow valve (small “button” in center of connector) to drain any water left in the city waterline.</i></li> <li>• One (1) valve located inside the passenger side front/tailgate storage compartments.</li> </ul>
	<b>Water Tank</b>	<ul style="list-style-type: none"> <li>• One (1) valve located inside the Water Service Center on the drivers side.</li> </ul>
	<b>Water Heater</b>	<ul style="list-style-type: none"> <li>• Drain water heater by opening the Easy drain lever and removing the filter.</li> </ul>
	<b>Water Heater Drain Valve</b>	<ul style="list-style-type: none"> <li>• One (1) valve located in the Water Service Center on the drivers side.</li> </ul>
	<b>Winterization Valve (Antifreeze Siphon)</b>	<ul style="list-style-type: none"> <li>• One (1) attachment located on the Water Center Panel in the Water Service Center on the drivers side.</li> </ul>

## SECTION 8 – ENTERTAINMENT

---

---

---

### AUDIO/VIDEO SYSTEM BASIC OPERATION

*NOTE: For your convenience, we have also included a handy, tear-out version of this “A/V System Basic Operation” guide in Section 8 of your Operator’s Manual Supplement.  
See your InfoCase for specific operating guides for audio and video components.*

---

---

### BLUE-RAY DISK™ PLAYER WITH DVD

#### –If Equipped

The Blue-Ray Disk™ player installed in your motorhome also plays DVDs, and connects to the internet using a LAN connection or a wireless connection.



-Typical View

### Further Information

See the manufacturer’s quick reference guide provided in your InfoCase for complete feature descriptions and operating instructions.

---

---

### TV ANTENNA – DIGITAL (Omnidirectional Digital HDTV Over-the-Air Antenna)

Your motorhome is featured with a omnidirectional digital antenna, which provides crystal clear digital HD reception of over-the-air channels in addition to superior broad reception range.

The digital antenna is equipped with a built-in amplifier for maximum VHF and UHF programming.

A built-in signal amplifier designed to strengthen signals, is controlled by a power switch on a wall plate assembly.

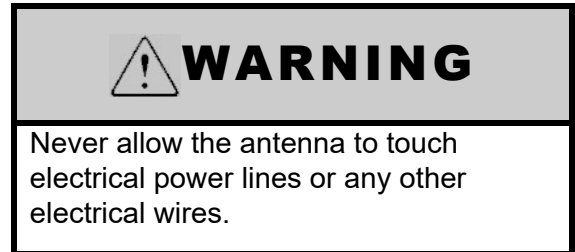

### Operating the Digital Antenna

- Turn the Digital Antenna Power Switch ON.

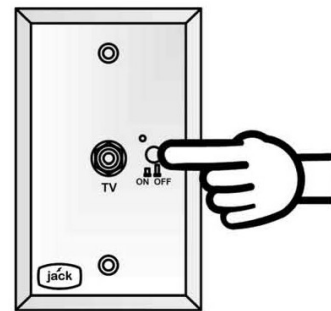

Digital Antenna Power Switch  
(Located in right hand cabover storage compartment)

*NOTE: Refer to television manufacturer’s instructions to scan for available channels.*

### Further Information

See the antenna manufacturer’s user guide provided in your InfoCase for complete operating and maintenance information.

---

---

### TV SIGNAL AMPLIFIER

The TV Signal Amplifier is built into the antenna and can be turned on or off with a power switch.

An indicator light will illuminate when the switch is on and the signal amplifier is active.

## SECTION 8 – ENTERTAINMENT

---

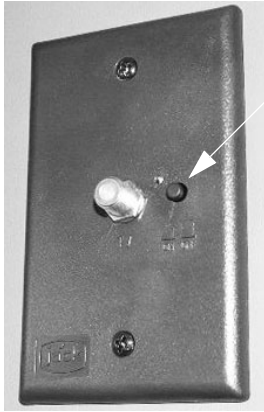

- Power Switch

TV Signal Amplifier Power Switch  
(Located in an overhead cabinet or mounted  
on a wall near the TV)  
-Typical View

---

### TV DIGITAL SATELLITE SYSTEM WIRING

Your motorhome is pre-wired for installation of a digital satellite TV system. Coaxial cable and high definition component cable connections are available to hook up your satellite receiver and are located in the entertainment center cabinet.

A second connection may be included inside a cabinet in the bedroom for the rear TV (if equipped).

See your authorized Winnebago Industries® dealer for proper installation and sealing of roof mounted components.



Interior Connection for Satellite Dish  
(Located on the passenger sidewall)  
-Typical View

---

### SATELLITE DISH AND CABLE TV CONNECTIONS (INPUT)

The portable satellite dish and cable television input connectors are located in the utility compartment, shoreline compartment, or water service center, depending on model.

To receive a cable signal, turn off the TV Signal Amplifier.



Satellite Dish and Cable TV Connections  
(Located on the Water Center Panel)  
-Typical View

**ACCESS PORT (ROOF)**

Your motorhome is equipped with a roof access port that provides a wiring path from an overhead cabinet to a sealed box on the roof for installing electronic devices such as Wifi and cell boosters, TV antennas, and satellites.

The roof access port is located inside the rear galley overhead. Remove plug to access.



Roof Access Port  
(Located inside rear overhead  
cabinet).  
-Typical View





# SECTION 9 – FURNITURE AND SOFTGOODS

---

---

---

## CAB SEAT LOUNGE CUSHION

–If Equipped

(Typical View – Your motorhome may differ in appearance)

The driver and co-pilot seats may feature a Lounge Seat Cushion which provides increased seat height and added comfort while in the lounge seating position. The Lounge Seat Cushion must not be used when the vehicle is in motion.

 **WARNING**

Do not use the Lounge Seat Cushion while the vehicle is in motion. Failure to comply may result in injuries.

1. Swivel seat to desired position.
2. Place Lounge Seat Cushion on seat.



Lounge Seat Cushion  
-Typical View

3. Route the Lounge Seat Cushion Strap around the back of the seat and latch. Pull strap to tighten.



Lounge Seat Latched  
-Typical View

---

---

## DINETTE TABLE (PORTABLE)

Your motorhome is equipped with an adjustable portable dinette table. The table has 3 adjustment levers that alter the height, length, and position of the table. Rotate the lever counter-clockwise to loosen for adjustment, and rotate clockwise to tighten. If the lever gets in the way, you can pull out on the lever to free spin it to a position that can be tightened again. To remove the table, loosen the lower lever and raise the table past the maximum height and the table will slide off.

## SECTION 9 – FURNITURE AND SOFTGOODS



The attachment point is located inside the passengers wall next to the main entry door.  
-Typical View



2. The table will lock in place.



There are 3 adjustment levers that alter the height, length, and position of the table.  
-Typical View



3. To collapse table, push upward on the support bar to release and lower.

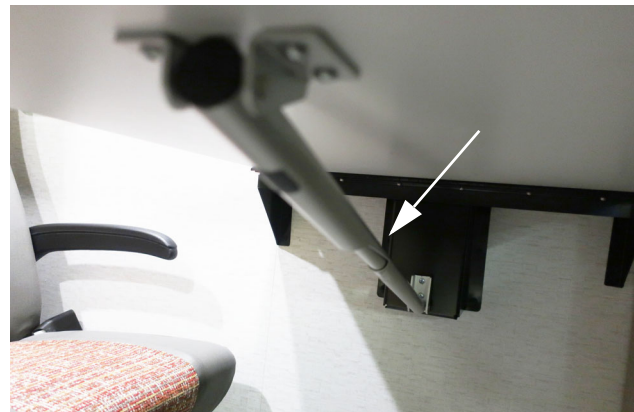

---

---

### DINETTE TABLE

(Typical View – Your motorhome may differ in appearance)

#### How to set up the dining table

1. Lift the table up from the bottom.

## SLEEPING FACILITIES

### **WARNING**

Sleeping facilities are not intended for use while vehicle is in motion. For safety, passengers must use safety belted seating positions while vehicle is in motion.

## BED – DELUXE SLEEP SYSTEM

–If Equipped  
(Typical View – Your motorhome may differ in appearance)

### Bed Conversion

- Locate the support cushion.



- Place the cushion in the space wood side down.

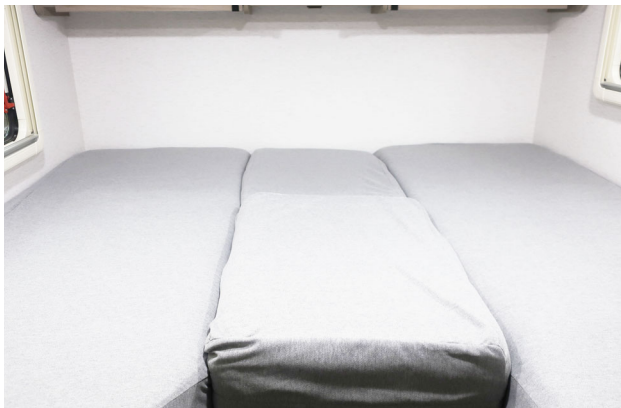

## POP-TOP SLEEP SYSTEM

–If Equipped

(Typical Views – Your motorhome may differ in appearance)

The Pop-Top sleep system allows for comfortable sleeping in an innovative, convenient way while maximizing available usage space in your motorhome. The bed can be accessed using the included ladder. The Pop-Top sleep system is weather resistant and can be used in mild to moderate conditions.

*Note: After using the Pop-Top sleep system in wet and rainy situations, ensure that the sleep system is opened up and dried out as soon as possible to prevent build up of mildew in the system.*

### **WARNING**

- **DO NOT** operate unless you have read and understood the operating guide.
- Before operating the vehicle always secure the sleeping roof unit by locking all four (4) mechanisms.
- Never operate the vehicle while the sleeping unit is unlocked.
- Keep hands and fingers clear while operating the sleeping roof.
- Use caution there is low headroom.
- **DO NOT** top load the roof while it is in the extended position.

### **CAUTION**

Secure four (4) latches on pop-top before driving. Failure to secure latches could result in damage to the pop-top.



## SECTION 9 – FURNITURE AND SOFTGOODS

---

### To set up the Pop-Top



Locate the retention clamps on the driver's and passenger's side of the Pop-Top, and push the black button to release.  
-Typical View

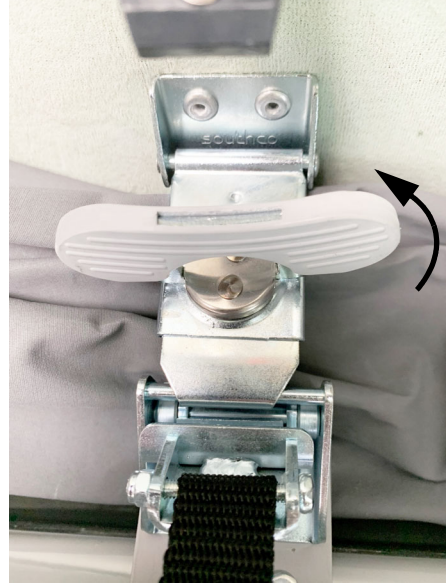

Pull out the turn knob and rotate to the left until the latch is extended.  
-Typical View

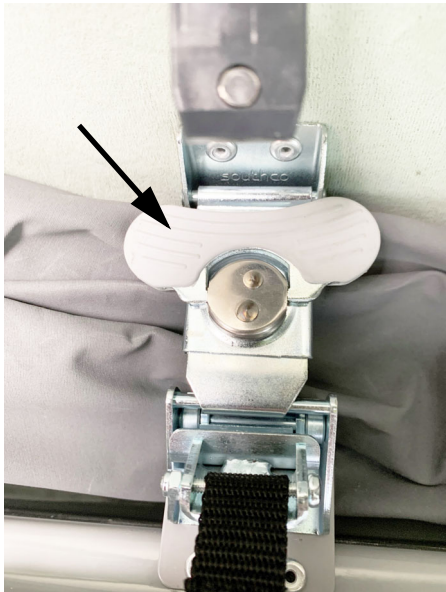

This will expose the turn knob in it's folded up stored position.  
-Typical View

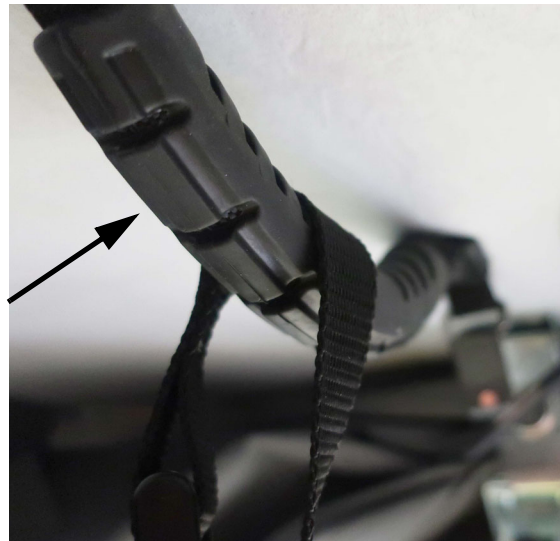

Pull down on one of the Pop-Top handles to create slack to release the latch. Follow these steps to release the driver's and the passenger's side.  
-Typical View

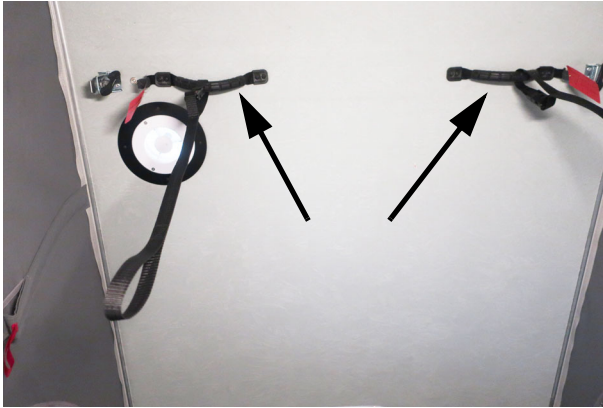

Press up firmly on the handles and lift the Pop-Top until the shocks take over and extend the Pop-Top to the extended position.  
-Typical View



The ladder is assembled using the latch system. Connect the 2 ends together making sure that the latches are in the open position.  
-Typical View



Shown with the Pop-Top fully extended.  
-Typical View



Hook the bottom piece of the ladder to the top and push down to clamp secure.  
-Typical View



## SECTION 9 – FURNITURE AND SOFTGOODS

---



Attach the ladder to the attachment points located on the passenger side. The ladder hooks in from the top.

-Typical View



Ensure that the turn knobs are folded back up and the retention clamps are secured before travel.

-Typical View



Reverse the steps to collapse the Pop-Top into the travel position. Use the straps that are attached to the handles to assist pulling the Pop-Top down. The red tab handles located on the sides are designed to pull the material inward, to ensure that the Pop-Top does not close down and pinch itself.

-Typical View

---

---

## WOOD FURNITURE AND CABINETRY

### -If Equipped

People are drawn to the natural beauty of wood. At Winnebago Industries®, our craftsmen work with the art found in each piece of wood to create cabinets of superior quality, backed by the Winnebago Industries warranty.

- Oak is a strong, open-grained hardwood that ranges in color from white to pink and reddish tones. Streaks of green, yellow, and even black may appear due to mineral deposits. Oak may also contain wormholes and wild, varying grain patterns. This distinct graining is considered a desirable quality and has made oak one of the most popular woods used for cabinetry.
- Maple is a close-grained hardwood that is predominately white to creamy-white in color, with occasional reddish-brown tones. While maple typically features uniform graining as compared to other wood species, characteristic markings may include fine brown lines, wavy or curly graining, bird's eye

dots and mineral streaks. These traits are natural and serve to enhance maple's natural beauty.

- Cherry is characterized by its red undertones, but may vary in color from white to a deep, rich brown. Cherry is a close-grained wood with fairly uniform texture, revealing pin knots and curly graining. All wood will age with time and the finish will darken. This is especially true for cherry. This is a sought-after quality in cherry cabinetry, and those who select it expect this evolution.

No matter which species you chose for your new Winnebago Industries motorhome cabinetry, please keep in mind that no two pieces of wood are exactly the same.

Stains are likely to exaggerate the difference between open and closed grains and other markings in wood. Grain variation and color change should be expected. As hardwood ages, it will darken when exposed to different types of light. Color differences or changes in wood can also be caused by exposure to harsh chemicals, extreme heat, or other contributing external conditions.

Any color change that occurs in both the finish and the wood is considered part of the natural aging process and is not to be considered defect or damage.

Additionally, wood species exhibit other defining characteristics, such as mineral deposits/streaks, knots, sap runs, pin holes, and wormholes. These markings make the wood unique and contribute to its enduring beauty.

Therefore, since wood is a product of nature and will have certain natural characteristics and variances, they are not covered under the warranty.



# SECTION 10 – MAINTENANCE AND STORAGE

---

---

---

## SEALANTS – INSPECTION AND GENERAL INFORMATION

Water is a recreational vehicle’s worst enemy when it is allowed to enter where it is not intended. Sealants perform a very important function and should be inspected closely and maintained regularly. Winnebago Industries® utilizes many different types of sealants. Refer to the “Sealants Call-Out Sheet” provided in your InfoCase for further information.

Sealants, in general, do not have “set” lifetimes. Varying environmental factors affect the pliability and adhesiveness of sealants. You or your dealer must:

- Inspect all sealants, a minimum of every six months.
- Inspect the moldings, windows, clearance lights, exterior compartment doors, and all their attachments.
- Also, inspect weather seals around entrance door, etc., and if necessary, have a dealer replace them immediately.
- Check for cracks, voids, gaps, breaks, adhesion, and any sign of physical deterioration.

*NOTE: Proper sealant inspection includes not just visual observation but running a finger along sealant seams to verify proper adhesion to the surface. Any loosened areas must be replaced.*

- Have the sealant replaced if you notice any of the above. Your local Winnebago Industries dealer has the correct and necessary parts and experience to help you maintain your sealants. See “Sealants Call-Out Sheet” provided in your InfoCase.
- Always use the same type sealant that was removed.
- Immediately have dealership check moldings, windows, and exterior attachments for leak source if you notice water inside of unit.

### NOTICE

Sealants must be inspected every 6 months and replaced if necessary.

---

---

## ROOF



### WARNING

STAY OFF ROOF. Surface may be slippery. Falling could result in death or serious injury.

The roof is made of Thermo-Panel materials like the walls and floor. It will support the weight of an average adult for periodic maintenance or repair of the roof or roof mounted components.

Walking or working on the roof should be left to qualified service personnel using proper safety equipment in a safe environment. You should only walk or work on the roof if you are qualified and have created a safe environment.

For your safety, it is not recommended that you store or carry items on the roof, unless it is secured in the luggage rack (see Miscellaneous section “Luggage Rack” for details).

Always have damage to the roof area repaired immediately. Damaged or detached sealant around the vents, air conditioner, body-to-roof seams, etc., should also receive immediate attention. Delaying these repairs may allow water leakage and result in damage to interior ceiling and body panels, upholstery, etc., which is not covered by the limited warranty (see “New Vehicle Limited Warranty” provided at the beginning of this manual).

## SECTION 10 – MAINTENANCE AND STORAGE

---

---

### UNDERCARRIAGE

Buildup of mud and dirt under the body of the vehicle can cause damaging rust or corrosion on steel or aluminum parts and can add needless weight to the vehicle. This, in effect, reduces the amount of cargo you can carry and remain within GVWR and GAWR limits.

Corrosive materials, such as those used for ice and snow removal and dust control, can also accumulate on the underside of a vehicle. These materials should be removed by flushing the undercarriage regularly with water, especially horizontal surfaces, cavities, and other areas where mud and other deposits may collect.

---

---

### EXTERIOR AUTOMOTIVE PAINT FINISH

The exterior finish of your motorhome is fully or partially finished with the highest quality automotive paint and clearcoat.

Follow these precautions to keep the finish looking its best and preserve maximum gloss and durability.

#### Parking

- **Avoid parking under trees** – When this happens you should rinse the bird droppings and tree sap off as soon as possible. Tree sap is a form of sugar and will dissolve after a couple of rinses. Bird droppings can eat into a painted surface if left unattended and need removed as soon as possible. Lukewarm soapy water can help speed up the cleaning process.
- **Avoid parking near salt spray** – When this happens you need to rinse off the salt mineral residue to minimize the corrosiveness of the salt.
- **Avoid parking near factories with heavy smoke or industrial fallout** – Industrial fallout can eat into your exterior finish when dew or rain mixes with it to create nitric or sulfuric acid that gets magnified by the intensity of the sun. As the water evaporates, the acid becomes more powerful and attacks

the painted surface.

Rinsing and washing the surface helps remove the fallout and neutralize the acid. After the initial 60-day cure stage, a coat of wax or polish can help protect the surface from these types of contaminants.

- **Do not scrape ice or snow from the painted surface.** Brush off gently with a soft-bristled snow brush – avoid being forceful with the brush.  
If brush scratches show after the motorhome thaws out, it may be possible to remove them by hand waxing with a silicone-free liquid wax.
- **Avoid covering painted surface.** When paint is covered (especially in outdoor conditions), water may appear between the cover and the motorhome due to rapid temperature fluctuations. The water may vaporize under certain conditions and migrate into the painted surface, possibly resulting in blisters and/or bubbles in the paint. These blisters/bubbles are not covered under warranty.  
Covering your motorhome is at owner's risk.

#### Driving

- Rinse off bugs and bird droppings with water daily.
- Antifreeze, fuel, or windshield/window solution spilled on the painted surface should be rinsed off immediately with water and allowed to air dry. Wiping dry with a towel may create fine scratches due to the solvent nature of these types of fluids.
- Fuel cannot be diluted and dissipated with water. It must be removed with a mineral spirit type cleaner (such as *SEAFOAM Bugs-B-Gone*, or equivalent) or a silicone-free spray wax and microfiber cloth to remove the stain left by fuels.
- Ensure that all motorhome fluids (such as gas, oil, grease, antifreeze, transmission fluid, brake fluid, etc.) are completely wiped off of painted surfaces. Failure to comply may cause the paint to blister and/or peel.



*NOTE: When driving in wintry conditions, the road surface may be covered with heavy salts or small rocks to improve traction. These types of road conditions may cause surface damage to your motorhome. If possible, it is best to avoid these types of exposures. However, if you do use your motorhome under these types of conditions, you may want to consider, among other things, washing both the undercarriage and the body of your motorhome after exposure to these types of conditions.*

## **Washing**

- Commercial vehicle wash facilities should be strictly avoided! They will scratch your motorhome!

*Truck-style wash centers have high-pressure wands that emit higher than necessary water pressures and the brushes are very aggressive. Most truck wash brushes are made from a heavy plastic for durability and are under heavy pressure. They are designed to clean heavy road films on semi trailers and are often dirty. They are not designed for custom painted motorhome's and they will scratch the clearcoat finish. Many times these scratches can penetrate the clearcoat finish, possibly causing delamination and/or other paint related issues that are not covered under warranty.*

- Wash your motorhome with cool or lukewarm water using a quality automotive detergent that does not contain bleach solution. Most auto stores offer car wash detailing soaps that are similar and do not have bleach in the formulation (such as Meguiars #62).
- Never use a bristled brush or broom to wash the painted surface. This will cause scratches in the finish. Using a microfiber cloth, mitt, or mop is strongly recommended.
- Be sure your cloth or applicator is clean. A dirty applicator can scratch your motorhome.

## **Washing Procedure**

- Rinse area to be washed with cold water to remove surface residue. Ensure you are not in direct sunlight.
- With area to be washed still wet from the rinse, use the recommended soapy mixture to clean the area. To avoid scratching painted surfaces, a microfiber cloth, mitt, or mop is strongly recommended to apply soapy water.
- Rinse washed area before soap evaporates.
- Dry the rinsed area before the water evaporates.

*NOTE: Avoid aiming water flow from a hose or spray from high-pressure washing equipment into any appliance intake, as damage or difficulty in operating appliances may occur.*

- After washing the motorhome, carefully inspect sealant around window frames, vents, and any other joints that may have loosened or separated. See “Sealants - Inspection and General Information” at the beginning of this section for details.

## **Bug Removal**

- Rinse any loose debris off with water and allow the remaining residues to soak and soften. Use soap and water to wash the residue, then rinse.

*NOTE: You may wish to repeat and leave soap on longer than normal to help with softening hardened residue.*

- For more stubborn areas, use an ammonia-based glass cleaner followed by washing with warm soapy water, then rinse.
- Remember to use microfiber towels during this process to help avoid scratches.
- If this does not work, as a last resort, use a bug removal product (like SEAFOAM Bugs-B-Gone, or equivalent) in a shady area and follow the directions on label. Ensure cleaner is completely wiped off of painted surfaces. Failure to comply may cause the paint to blister and/or peel.

## SECTION 10 – MAINTENANCE AND STORAGE

---

### Polishing and/or Waxing

*NOTE: When your motorhome is new or has been repainted for any reason, no polish or wax should be applied to the finish until after a 60-day cure cycle at temperatures higher than 60 degrees for 60 days. Failure to observe this precaution could void your paint warranty.*

- We recommend a silicone-free polish with an orbital machine and terry cloth applicator.
- Liquid waxes are easier to apply and bring to a gloss with fewer residues.
- Avoid paste waxes. They sometimes have fillers and additives that give a very short term result. Stay away from silicones in polishes and soaps.
- Buffing compounds remove some of the mil film of the clearcoat, so we recommend that only professionals or very experienced users apply this type of product.

### Inspection

A motorhome exterior is subjected to many physical forces and environmental conditions. While the motorhome is parked, it is exposed to climate and weather extremes and other environmental conditions. While in operation, it is subjected to various twisting and flexing forces caused by routine cornering and turning, and by uneven road surfaces, such as bumps, potholes, railroad tracks, and parking lot entrances.

Inspect the exterior fiberglass shell periodically for cracks which may represent a threat to the integrity of the fiberglass.

Minute cracks in the surface (commonly referred to as "spider cracks" or "hairline cracks") caused by normal flexing of the fiberglass exterior are normal and typically pose no threat to the integrity of the motorhome other than appearance.

However, if a crack has opened up and the weave of the cloth is visible, this does represent a threat to the integrity of the fiberglass and must

be repaired or covered as quickly as possible to avoid penetration by moisture, especially in freezing climates.

If the fiberglass has been damaged and contains cracks, tears, or holes, use plastic sheeting and duct tape, if necessary, to prevent moisture from damaging the sidewall material or the interior of the motorhome.

### Protective Film

#### –If Equipped

Your motorhome may be equipped with a protective film to defend against everyday road hazards. This film creates a barrier against bugs, road grime, bird droppings, and other harmful elements.

#### Further Information

See the manufacturer's information provided in your InfoCase for complete care and maintenance instructions.

---

## EXTERIOR GRAPHIC CARE

The pressure-sensitive graphics on your vehicle require very little maintenance. In order to allow the graphics to have the longest life possible, the following steps should be taken.

- Wash graphics with plain soap and water or any car wash detergent. Rinse thoroughly.
- High pressure water spray may loosen or damage graphics. Keep spray nozzle at least 1 1/2 feet from the edge of the graphics.
- Test any cleaning solution on a small section of graphic before using.
- Never use aromatic solvents such as acetone, M.E.K., toluene, paint thinner or lacquer thinner on graphics. Solvents may soften the vinyl and smear colors.
- Gasoline or other fuels spilled on graphics should be rinsed off immediately with water.
- Do not apply paint or clearcoat over the graphics.
- Do not apply wax over the graphics, especially wax containing petroleum distillates. Wax that has dried along the edge

of a graphic can be removed with cotton swabs after softening it with isopropyl alcohol. Rinse area thoroughly after cleaning.

---

---

## **PLASTIC PARTS – CLEANING**

Many parts in your vehicle, such as the dash, exterior light lenses, and certain exterior body panels are made of high-impact plastic materials that can be damaged by wiping with solvents or improper cleaning products.

Always try cleaning plastic parts with the mildest cleaners first and work your way up to stronger cleaning products. Use the following cautionary lists as a guide when selecting cleaning products to use on plastic parts.

<h3><b>NOTICE</b></h3>
Do not use citrus-based cleaners on polycarbonate finishes. Citric compounds will damage the high-gloss surface, causing it to appear dull or “flat”. Always test a cleaning product on a hidden area to be sure it will not cause damage to the appearance of the part.

Here is a list of mild cleaners that **may be used safely**:

- Car washing soap and water
- Glass cleaners *without ammonia*
- Mineral oil
- Multipurpose cleaners (such as Fantastik<sup>®</sup>, Formula 409<sup>®</sup>, etc.)

The following products, compounds, or solvents must be **wiped off immediately** to avoid damage:

- Ammonia
- Brake fluid
- Bathroom basin, tub, and tile cleaners
- Chlorine
- Ethyl alcohol
- Isopropyl (rubbing) alcohol
- Kerosene or gasoline

- Naphthalene
- Pine-type household cleaners

**Do not use** cleaners containing the following products, compounds, or solvents. These products **will damage** the finish.

- Acetic acid
- Acetone (nail polish remover)
- Aromatic solvents (lacquer thinners)
- Benzene
- Butyl alcohol

---

---

## **EXTERIOR LIGHTS**

Most Winnebago Industries<sup>®</sup> vehicles have polycarbonate lenses on exterior lamps, which are very sensitive to a variety of chemical solvents and cleaners.

Use only soap and water to clean exterior lamp lenses, especially headlights.

- Contact with certain chemicals can cause etching, “crazing” or cracking of the lens, which can significantly reduce the lens clarity and effectiveness of the lamp and may require replacement of the complete lamp housing.
- Some popular citric acid cleaners may cause polycarbonate lenses to become “hazy” or “foggy”.
- Do not use a pressure washer to clean headlights.
- Inspect and operate the lights regularly to confirm proper operation and mounting condition.

---

---

## **INTERIOR SOFT GOODS**

We recommend a weekly routine of vacuuming all fabrics and carpet throughout the motorhome to prevent an accumulation of dirt, which can detract from the appearance and shorten the life of carpet and fabrics.

### **Fabric Upholstery**

Some fabrics used in this motorhome may contain fire retardant and lightfastness additives, which can be damaged by use of improper cleaning products. Some water-based household

## SECTION 10 – MAINTENANCE AND STORAGE

---

cleaning products are not formulated for use on fabrics and may cause excessive shrinkage or fading. Always test any cleaning product on a hidden area of fabric before using on visible areas. For best results, fabric cleaning should be referred to a professional carpet and upholstery cleaner.

*NOTE: To minimize fading of upholstery, carpets and other interior fabrics caused by excessive sunlight, the drapes, blinds, or shades should be closed when the motorhome is parked for an extended period of time.*



### **WARNING**

When cleaning upholstery and fabric, do not use lacquer thinner, nail polish remover, laundry soaps, or bleach. Never use carbon tetrachloride, gasoline, or naphthalene for any cleaning purpose. These materials may cause damage to the material being cleaned and most are highly flammable, posing risk of injury due to fire.

### **Leatherette –If Equipped**

Leatherette materials are easy to care for and require no recommended maintenance other than regular cleaning. To clean, only use:

- Mild soap and water
- For stubborn spots, use alcohol-based solutions such as Fantastik® or Formula 409®
- To disinfect, use a 5:1 bleach/water solution
- Always rinse with clean water
- Allow to air dry

### **Vinyl Fabrics (including ceiling) –If Equipped**

Vinyl should be cleaned with a soft, damp cloth, and a mild detergent only. Do not use solvents. Solvents may damage the surface of the vinyl.

### **Draperies, Curtains, and Bedspreads**

These items may be woven from a variety of fabrics. We recommend that these be professionally dry cleaned only. A five percent shrinkage may occur when you have these items dry cleaned.

### **General Stains**

As with any stain or contamination, the quick response is the best, especially when done in conjunction with the proper cleaner for the type of stain.

---

---

## **CABINETRY – CLEANING**

Wooden items may be cleaned with a soft cloth and a good quality wood finish cleaning product.

Vinyl simulated wood panels may be cleaned with a mild, water-based cleaner and a soft cloth. Do not use solvents on vinyl wood panels.

*NOTE: Many cabinetry and furniture items throughout this motorhome are constructed either partially or completely of real hardwoods. Because of natural variations in woodgrain density, slight differences in stain hue may exist between one item and another. This is the distinctive character and beauty of real wood.*

---

---

## **DECORATIVE VINYL WALL PANELING – CLEANING**

Decorative Vinyl Wall Paneling may be cleaned with mild detergent and warm water. The soap product should contain no abrasives, and the use of a soft cloth or sponge with the cleaning liquid should help preserve the finish of the vinyl.

Do not use bleach, cleaning agents with solvents or harsh chemicals, oil based spray cleaners, or other multipurpose cleaners such as Fantastik® or Formula 409® as they could damage the vinyl surface.

## **TABLES AND COUNTERTOPS**

Work surfaces are covered with a plastic or thermo-formed laminate that resists solvents, stains, and abrasions. A coat of furniture wax applied to these surfaces on the counters and table will help preserve their beauty and make cleaning easier. Always clean the surface before applying wax.

---

---

## **SINK – STAINLESS STEEL**

### **Care and Cleaning Instructions**

The stainless steel sink can usually be cleaned with water and soap or detergent using a soft cloth or sponge.

- **Rinse thoroughly** with warm water and wipe dry quickly to avoid spots and streaks.
- **For stubborn stains**, use a mild abrasive cleanser like Soft Scrub<sup>®</sup>, Comet<sup>®</sup>, etc. Work in the direction of the “grain” of the brushed finish lines.
- **Never use steel wool.** Particles of steel from the wool pad can embed into the sink surface, then become rusty and unsightly.
- **Avoid contact with full-strength** bleaches, household chemicals, and acid-based cleaners. If this happens, rinse and wipe dry quickly.
- **Salt, mustard, and mayonnaise** can cause pitting if left on the steel sink surface. If spilled, clean and rinse immediately.
- **A high iron content** in the water (hard water) may result in a brown or rust-colored stained appearance. If noticed, dry towel sink after each use.
- **Do not use rubber mats** in the sink bowl. Material trapped under mats can complicate cleaning.

*NOTE: Improper use may damage this product and void the warranty.*

## **RANGE AND REFRIGERATOR**

For care and appearance maintenance of the range and refrigerator, refer to the appliance manufacturer’s operation and maintenance manuals included in your InfoCase.

---

---

## **VINYL FLOORING**

### **Care and Maintenance**

You can easily maintain the beauty of your vinyl flooring with little effort, by following these recommendations:

- Sweep or vacuum floor daily (use a vacuum without a beater bar head.) Remove loose dirt with a soft brush or Swiffer<sup>®</sup> type product.
- For more intense cleaning, use a non-abrasive cleanser, such as Mr. Clean<sup>®</sup>. Rinse with clean water.

*NOTE: Floor cleaners containing waxes, brighteners, or gloss agents are not recommended.*

- Regular cleaning with solvent-based chemicals may adversely affect the topcoat performance.
- Do not use undiluted bleach or leave a dilution of bleach on the floor for longer than one hour.
- Vinyl flooring is extremely durable and long lasting. It is normal for the floor to show some denting and dimpling where furniture sets due to the soft nature of the material. The dents are not permanent and will come out over time.

### **Spill Removal for Water Based Spills**

- Remove the solid material from the spill before cleaning.
- Mix 1/4 to 1/2 teaspoon of clear hand dish-washing detergent with 1 cup of water. Use this to dampen a sponge or towel and wipe until the spill is gone.
- Use clean water to wet a towel and rinse the soap from the spill area until all of the soap and spill is gone.



## SECTION 10 – MAINTENANCE AND STORAGE

---

- Inspect to ensure that there is no remnants of the spill left behind in the weave, including the cracks, as this can create further issues.

### Spill Removal for Oil Based or Greasy Spills

- Select a grease removing household detergent that is non-bleaching that contains no grit in it to clean the spill area.
- Follow the detergent container's directions located on the bottle to clean the spill area.
- After the entire spill is removed return to the steps listed before on "Spill Removal for Water Based Spills" and follow the directions completely.

### Maintenance Tips

- Install protection (such as pads or casters) on furniture with legs or sharp edges. This protection should not contain bitumen, which may cause brown stains.

*NOTE: Faulty pads and casters should be removed and replaced.*

- Burning cigarettes and matches can cause damage to the flooring.
- Use doormats (that do not contain bitumen) to keep out most of the dirt and dust.
- Remove spills immediately with a damp cloth, followed by rinsing with clean water.
- The use of stiletto heels is not recommended, as they may cause permanent damage to the flooring.
- Protect flooring from prolonged direct sunlight exposure.

### Treatment of Stains

**Acids, alkali, alcoholic beverages, coffee, soft drinks, ketchup, fruit, fruit juices, food, vegetables, mustard, ink, and iodine:**

- Remove the stain with lukewarm water and a cloth or sponge. If necessary, clean with a soft nylon pad and non-abrasive mild detergent or resilient floor cleaner.

#### Heel marks:

- Clean as soon as possible with a soft nylon pad and non-abrasive mild detergent or resilient floor cleaner.

#### Asphalt, candle grease, chewing gum, fat, oil, tar, and shoe polish:

- Gently remove with a blunt instrument and treat with a soft nylon pad and non-abrasive floor cleaner.

#### Lacquer and nail polish:

- Remove as soon as possible. Do not allow to dry. If necessary, apply nail polish thinner (sparingly) to remove any residue.

#### Corrosion, paint, and grass stains:

- Treat as soon as possible with a soft nylon pad and non-abrasive mild detergent or resilient floor cleaner.

#### Varnish, oil paint, and solvents:

- Blot up as soon as possible. Do not rub, as this will only spread material further across the surface. Carefully treat with a mild cleanser. When dry, carefully peel the stain off. MEK may be used sparingly, if necessary. Rinse immediately with clean water.

#### Pet stains:

- Treat with lukewarm water. If stain remains visible, clean with a soft nylon pad and non-abrasive resilient floor cleaner.

### Further Information

Refer to the quick reference guide located in your InfoCase for further information.

---

---

## BATHROOM

### Toilet

For instructions on the care of your toilet, refer to the information in your InfoCase.

### Tub and Shower Walls

The tub and shower walls in the bathroom should be cleaned with mild soap and warm water. Do not use an abrasive cleaner on the

shower walls and tub, as scratching and discoloration may occur. Stubborn stains may be removed with an automotive-type cleanser.

## **Lavatory Sink**

### **Glossy Ocritch sink- if equipped**

Clean using a damp cloth or sponge with a liquid soap, which does not contain abrasive particles. Rinse with water. Use a microfiber cloth to wipe. **ABSOLUTELY DO NOT USE** abrasive detergents, alcohol, acetone or other types of solvents, because they will damage the material. In case of accidental contact with such solvents quickly rinse with water. To keep the surface glossy, apply periodically some common polish.

### **Opaque Ocritch sink- if equipped**

Clean using a sponge such as Scotch-Brite with a powder abrasive detergent. Rinse with water. Use a microfiber cloth to wipe. **ABSOLUTELY DO NOT USE** alcohol, acetone or other types of solvents, because they will damage the material. In case of accidental contact with such solvents quickly rinse with water.

### **Marks or Discoloration**

A color-matched automotive scratch remover compound may be used to remove stubborn marks or discoloration. Always follow label directions.

*NOTE: Do not use steel wool or metal scouring pads.*

---

---

## **DOORS AND WINDOWS**

Windows may be periodically cleaned with a good quality glass cleaner or mild soap solution using a soft cloth.

Use care when removing ice or frost from the windows. Always use a plastic ice scraper, never one made of metal. Use care when removing ice from the mirrors to protect the reflective surfaces.

Door locks and hinges should be lubricated periodically with powdered graphite to ensure trouble-free operation and to protect against freeze-up.

---

---

## **VEHICLE USAGE IN COLD WEATHER**

Your motorhome has been designed to accommodate cold weather usage and should provide many opportunities to enjoy the outdoors in every season. Vital operating systems and plumbing pipes have been designed within the coach and when used properly, can support water systems in temperatures that drop below freezing. Using the motorhome in severe conditions, when temperatures drop below 10°F, may require additional precautions to prevent damage. These include draining water lines and adding RV antifreeze to prevent freeze damage to water lines, tanks, and plumbing hardware. See “Winterizing Procedure” in *Section 7 - Plumbing*.

Whenever you are driving in freezing weather please be advised that your speed has the same effect as wind chill, rapidly cooling exposed surfaces to lower temperatures. If the coach is not winterized, you must use the coach heating system in conjunction with the cab heater and the electric tank heater to maintain temperatures and prevent freezing of water systems.

In all weather conditions, you are responsible for your safety. Make sure you have back up sources for warmth and whenever you are exploring remote locations use careful trip planning - just like you would on a remote backpacking trip.

---

---

## **VEHICLE STORAGE – PREPARATION**

Properly preparing your vehicle for storage will lessen the possibility of damage to your vehicle. Prepare the motorhome for vacancy just as you would if you were leaving your house for an extended period.

### **Clean and Prep Motorhome for Storage**

1. Turn off the propane gas tank.
2. Turn the Electronic Thermostat switch OFF.

## SECTION 10 – MAINTENANCE AND STORAGE

---

3. **Remove all foods and items that may cause odors from cabinets and refrigerator.**
4. Clean and defrost the refrigerator. Prop the door open slightly to allow any odors to dissipate. Place an open box of baking soda inside the refrigerator to help absorb odors.
5. **Fully charge the batteries. Batteries must have at least 80% charge to survive freezing temperatures and long period of non-use.** We recommend that you connect a battery charger or plug in the shoreline once a month during long-term storage periods to maintain battery charge and to avoid sulfating. If connecting a charger directly to batteries, turn the House/Coach Battery Disconnect switch off to avoid electrical arcing when attaching and detaching charge clamps.

*NOTE: We do not recommend leaving the shoreline plugged in continuously during storage.*

6. After charging batteries, turn the House/Coach Battery Disconnect switch off to disconnect the batteries and avoid parasitic\* drain.  
  
*\*Parasitic battery drain is the gradual drain by items connected directly to battery power such as clocks, radio memory, and the engine computer.*
7. Have the vehicle chassis completely serviced and lubricated. Be sure radiator antifreeze protection level is sufficient for the lowest anticipated temperatures.
8. Wash and wax the motorhome.
9. Inspect all seams and seals around doors, windows, vents, and any other joints. Replace or repair any that are damaged. Sealing materials and compounds can be purchased from your dealer. Badly damaged weather seals may need to be replaced by your dealer.
10. Close all windows and roof vents. Protect all appliance vent openings from contamination by animals or insects (e.g. bird nest, wasp nests, etc.)
11. Lubricate all door hinges and locks.

12. Clean the interior of the motorhome. Dirt and stains are more easily removed when fresh.

If you are storing your vehicle through the winter, or in cold climates, extra preparations must be made to protect equipment and systems that can be damaged by freezing temperatures. See “Winterizing Procedures” in *Section 7 - Plumbing*.

---

## VEHICLE STORAGE – REMOVAL

1. Completely air out the motorhome.
2. Have the entire LP gas system checked for leaks.
3. Check window operation.
4. Check cabinet and door hinges. Lubricate with penetrating oil, if necessary.
5. Close all faucets and drain valves that are open.
6. Add a few gallons of water to the fresh water tank and turn on the water pump to check for leaks, especially at fittings.
7. Open all faucets in turn to release trapped air and check to be sure faucet washers have not hardened during storage.
8. Sanitize the water system as outlined under *Disinfecting the Fresh Water System* in the Plumbing section, then flush the waterlines thoroughly with fresh water.
9. Check the toilet for proper operation.
10. Add water to the holding tank using the toilet flush pedal and galley sink faucet. Check to be sure dump valves seal tightly.
11. Check around all appliances for obstructions and ensure that all vent openings are clear.
12. Start refrigerator and check for proper cooling.
13. Clean wall and counter surfaces.
14. Replace batteries, if necessary, and check out electrical system to make sure all lights and electrical components operate.

15. Check tires for proper cold inflation pressure. See “Vehicle Certification Label” in *Section 1 - Introduction*.
16. After washing accumulated winter grime from the vehicle, it is important to carefully inspect the seams and sealants for separation or cracks that may have appeared around the window frames, vents, and any other joints. See *Sealants – Inspection and General Information* at the beginning of this section. Resealing is quite simple and the material is quickly and easily applied. Appropriate compounds are available from your dealer. See the *Sealants – Recommended Application* page in the Supplement Manual provided in your InfoCase. Also inspect weather seals around doors, etc., and if necessary, have a dealer replace immediately.

---

---

## **CHASSIS SERVICE AND MAINTENANCE**

Consult the appropriate sections in the chassis manual for specific information regarding operating safety, service recommendations, and maintenance schedules for the chassis section of your vehicle.

# SECTION 10 – MAINTENANCE AND STORAGE

## MOTORHOME MAINTENANCE CHART

These recommendations apply for normal recreational use. Heavy duty or full-time use may require more frequent maintenance intervals.

Always use specified sections or manufacturer's guide for further information and instructions.	Before Each Use	Weekly	Monthly	Every 3 Months	Every 6 Months	Every Year	As Necessary
<b>Propane Gas System</b>							
Have propane gas system checked for leaks						◆	◆
Pressure Regulator - inspect and adjust if needed						◆	
Check propane tank condition, mounting, and fittings						◆	
<b>Electrical System</b>							
Check Battery Condition Meter	◆						
Check battery fluid level and connections			◆				
Check 12V fuses and 120V breakers							◆
Check GFCI receptacles			◆				
<b>Generator</b>							
Visually inspect generator and compartment	◆						
See generator manufacturer's maintenance guide							◆
<b>Plumbing System</b>							
Sanitize plumbing system							◆
Winterize plumbing system							◆
Clean water pump strainer filter						◆	◆
Visually confirm bilge pump is discharging shower waste water							◆
<b>Exterior</b>							
Clean roof				◆			◆
Clean sidewalls			◆				◆
Clean windows							◆
Flush underside of vehicle				◆			◆



**SECTION 10 –  
MAINTENANCE AND STORAGE**

**MOTORHOME MAINTENANCE CHART**

These recommendations apply for normal recreational use. Heavy duty or full-time use may require more frequent maintenance intervals.

Always use specified sections or manufacturer's guide for further information and instructions.	Before Each Use	Weekly	Monthly	Every 3 Months	Every 6 Months	Every Year	As Necessary
<b>Safety Equipment</b>							
Check operation of the following items:							
Headlights, Taillights, and Marker Lights	◆		◆				
Turn Signals	◆		◆				
Horn	◆		◆				
Hazard Warning Flashers	◆		◆				
Windshield Wipers and Washers	◆		◆				
Headlight Alignment							◆
Fire Extinguisher - check charge indicator	◆		◆				
Smoke Alarm - test operation *	◆		◆				
Carbon Monoxide Alarm - test operation *	◆		◆				
Propane Gas Leak Detector - test operation	◆		◆				
(*replace battery if needed)							
<b>Appliances</b>							
<b>Water Heater</b>							
See water heater manufacturer's maintenance guide							◆
Inspect and clean exterior vent	◆						◆
<b>Refrigerator</b>							
See refrigerator manufacturer's maintenance guide							◆
<b>Furnace</b>							
See furnace manufacturer's maintenance guide							◆
Inspect and clean exterior vent	◆						◆
<b>Air Conditioner</b>							
See A/C manufacturer's maintenance guide							◆
Inspect for exterior damage				◆			◆
Check/replace filter			◆				
<b>Range Top</b>							
See range manufacturer's maintenance guide							◆

# SECTION 10 – MAINTENANCE AND STORAGE

## MOTORHOME MAINTENANCE CHART

These recommendations apply for normal recreational use. Heavy duty or full-time use may require more frequent maintenance intervals.

Always use specified sections or manufacturer's guide for further information and instructions.	Before Each Use	Weekly	Monthly	Every 3 Months	Every 6 Months	Every Year	As Necessary
<b>Sealants</b>							
Inspect (see "Sealants - Inspection and General Information" at the beginning of this section for proper inspection technique)					◆		◆
Replace (see "Sealant Call-out Sheet" in the supplement manual provided in your InfoCase)							◆
<b>Frame &amp; Chassis</b>							
Follow chassis manufacturer's maintenance guide (refer to chassis manual)							◆
Inspect hitch receiver (if towing)	◆						
<b>Tires</b>							
Check and adjust air pressure	◆						◆
Check tread wear	◆						◆
Check front end alignment and adjust if needed							◆
<b>Miscellaneous</b>							
Lubricate locks, hinges, and latches						◆	◆

## SECTION 11 – MISCELLANEOUS

---

---

---

### LOADING THE VEHICLE

*NOTE: Your motorhome's load capacity is designated by weight, not by volume, so you cannot necessarily use all available space when loading your motorhome.*

- Store or secure all loose items inside the motorhome before traveling. Possible overlooked items such as canned goods or small appliances on the countertop, cooking pans on the range, or free-standing furniture items can become dangerous projectiles during a sudden stop or evasive maneuver.
- Be aware of GVWR, GAWR, and individual load limit on each tire or set of duals.

When loading the vehicle, distribute the cargo load equally so that you do not exceed either the Front or Rear Gross Axle Weight Rating (GAWR) or the Gross Vehicle Weight Rating (GVWR). The Gross Axle Weight Rating (GAWR) means the weight value specified by the chassis manufacturer as the load carrying capacity of a single axle system as measured at the tire-to-ground interfaces. This is the total weight a given axle is capable of carrying. Each axle has its own rating.

Have your vehicle weighed to determine the proper load distribution for your vehicle. Also distribute cargo side-to-side so the weight on each tire or dual set does not exceed one half of the GAWR for either axle.

For example, if the Front GAWR is 6,000 lbs., there should be no more than 3,000 lbs. on each tire. (If the left side weighs 3,100 lbs. and the right side weighs 2,700 lbs., at least 100 lbs. of the load must be shifted from the left side to the right side.) The GVWR is listed on the Vehicle Certification Label. (See sample in *Section 1 - Introduction*).

The GCWR (Gross Combination Weight Rating) means the maximum allowable loaded weight of this motorhome and any towed trailer or towed vehicle.

*NOTE: We recommend that you dump all holding tanks before traveling to avoid carrying unnecessary weight.*



### WARNING

The weight of the loaded vehicle (including options, attachments, passengers, water, fuel, luggage, and all other cargo) must not exceed the GVWR or GAWR of either axle.

---

---

### WEIGHING YOUR LOADED VEHICLE

To check the weight of your fully loaded motorhome, locate a commercial weighing scale that is capable of weighing large trucks.

*NOTE: Sales literature may give approximate or standard weights. Your actual motorhome weight may differ based on added factory and/or dealer options.*

#### Loading

Load your vehicle completely as if you were going on a long trip with everything you would carry, including food, clothing, bedding, lawn chairs, etc., a full fuel tank, full propane tank, and a partial tank of fresh water, but empty holding tanks. Remember, tongue weight must be included in the GVWR.

#### Finding a Scale

In urban areas, the most common places to find a public access scale are commercial truck stops. In rural areas, most grain storage elevators have scales available. Most scales charge a nominal fee for weighing a vehicle.

#### Weighing

There is typically a scale operator to direct you, but the basic routine is to take three separate weights - front axle, whole vehicle, and rear axle.

## SECTION 11 – MISCELLANEOUS

You will first drive only your front wheels onto the scale pad, then drive ahead so that the whole vehicle is on the scale, then finally pull off until just the rear wheels are on the pad.

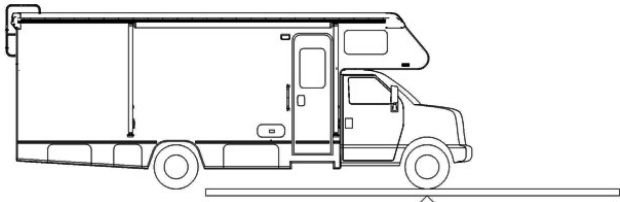

Front GAWR (Front Axle Only)

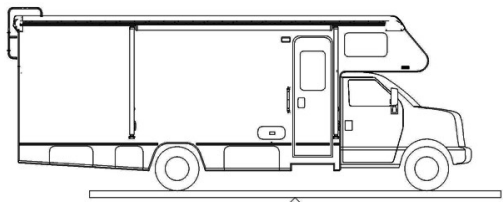

GVWR - Whole Vehicle (All Axles)

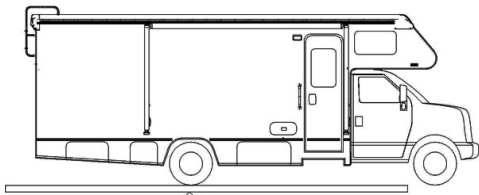

Rear GAWR (Rear Axle Only)

You will receive a weight “ticket” that states your current Front Gross Axle Weight, Rear Gross Axle Weight, and Gross Vehicle Weight. You can compare these weights to the weight ratings listed on your Vehicle Certification Label to use as a guideline for future loading limits and weight distribution.

The gross weight of the vehicle must not exceed the Gross Vehicle Weight Rating (GVWR) specified on the Vehicle Certification Label. The front and rear axle weight also should not exceed the corresponding Axle Weight Rating specified on the Vehicle Certification Label.

### Corner Weighing (Side-to-Side)

The most accurate method of weighing a motorhome is to weigh each “corner” of the motorhome separately (single L/R front wheels or L/R rear dual sets.) This method will help you determine how to distribute your cargo to avoid overloading, especially on tires.

To determine the weight distribution on each tire or dual set, you will need to find a scale capable weighing side-to-side, or all four “corners” of the vehicle separately.

A truck scale may be used if the ground is level with the scale surface and the scale has clearance to drive one side of the motorhome onto the scale as shown.

Drive the motorhome on the level area next to the scale and straddle the scale so that only one side of the motorhome will be on the scale pad.

*NOTE: Wind and precipitation can also cause weight inaccuracies.*

Pull only the right front wheel onto the scale pad as shown.

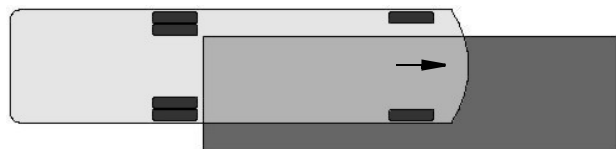

Weighing Right Front Corner

When the front wheel has been weighed, pull the motorhome straight ahead until only the right rear wheel/dual set is on the scale pad as shown.



Weighing Right Rear Corner

Now, turn the motorhome around and repeat the process for the other side.

The load on each wheel or dual-wheel set should not exceed one-half of the corresponding GAWR. For example, if the GAWR for the rear

axle is 12,000 lbs., then the load on each rear dual set (left rear duals or right rear duals) should not exceed 6,000 lbs.

Tires must be filled to the recommended air pressure for the highest loaded tire set on that axle. For example, on the rear axle, if the left side weighs more than the right, fill the left tires to the pressure required for that weight, then fill the right tires to the same pressure as the left ones.

If your actual weight is considerably less than GAWR, you may be able to lower your tire pressure. See a tire dealer for a load/pressure chart.

*NOTE: The Hitch Load from a Towed Vehicle or carrier box must also be counted on the Rear GAWR and subtracted from the rear axle cargo capacity.*

Be aware that hitch load can affect handling characteristics. The more weight on the hitch, the lighter the front end will feel at the steering wheel.

---



---

## **CAR OR TRAILER TOWING**

**–If Equipped**

**Hitch Capacity\***

**5,000 lbs. max.**

**Tongue Weight\***

**500 lbs. max.**

The factory installed towing hitch on this motorhome is capable of pulling 5,000 lbs. load (max.), however, the vertical (tongue) weight may vary according to chassis and model combinations

(\*see label on hitch). Towing capacity may be less than hitch rating.

When towing a trailer or vehicle, do not exceed either the GVWR, the rear axle GAWR, or the chassis GCWR (the combined loaded weight of the motorhome and the towed vehicle). See preceding items “Loading the Vehicle” and “Weighing Your Loaded Vehicle” for explanation of weight ratings.

Because of individual vehicle use and loading habits, we recommend weighing the vehicle while fully loaded to avoid exceeding any of the listed Gross Weight Ratings. See “Vehicle Certification Label” in the Introduction section for information on gross weight ratings.

Towing will affect vehicle handling, durability, and fuel economy. Exceeding any of the listed Gross Weight Ratings will result in unacceptable overall vehicle performance. Maximum safety and satisfaction when towing depends on proper use of correct equipment.

When towing a vehicle behind your motorhome, the tow bar should be level or pointing slightly upward towards the tow vehicle.

When coupling the vehicle tow bar to the Factory Receiver Hitch using a “drop receiver” or a conventional “ball mount” (commonly referred to as a “stinger” or a “draw bar”), do not exceed a 4” drop, nor one that the centerline of the hitch pin to the centerline of the ball exceeds 8”. See the following Hitch Assembly illustration.

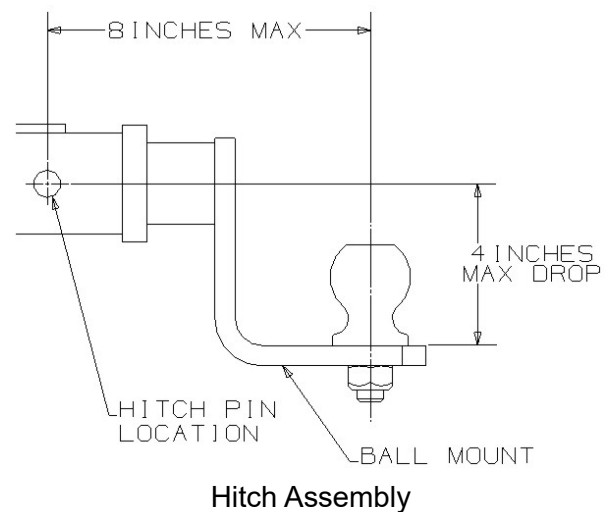

If a towing “brake system” is required, we recommend that a “modulated” towed vehicle braking device be installed. This means that when the motorhome brakes are applied, whether hard or soft, a mirror effect occurs in the braking of the towed vehicle. In other words, the more



## SECTION 11 – MISCELLANEOUS

force applied to the motorhome brakes, the more force will be applied to the rear vehicle's braking system.

We do not recommend the usage of a “surge-style” braking device. The usage of a surge brake (especially when coupled with a hitch ball located outside our recommended limits) places excessive stress on the hitch. This abuse of the ball mount and the hitch may cause premature hitch assembly failure.

Finally, do not forget to consider the actual tongue weight. This should not exceed the stated hitch vertical load for your vehicle. This weight is typically defined as the tongue weight of a towed vehicle hitch, boat trailer tongue weight, or a receiver-mounted carrier rack.

Check state regulations on trailer weight and trailer brake requirements to be sure you select the right equipment before towing.

Before descending a steep or long grade when towing a trailer, reduce speed and shift into a lower gear to control vehicle speed. Avoid prolonged or frequent application of brakes, which could cause overheating and brake failure.



### WARNING

For safe towing and vehicle handling, maintain proper trailer weight distribution. The total weight of the motorhome and the vehicle towed must not exceed the Gross Combined Vehicle Weight rating. See the Body and Chassis Specification chart in the Introduction section.

### NOTICE

Exceeding any of the recommended gross vehicle weight ratings may result in vehicle damage. Do not install a frame equalizing-type hitch on your vehicle.

## TRAILER WIRING CONNECTOR

Your motorhome is pre-wired for trailer or car towing lights with a 7-pin socket.

The following diagram shows proper connection of trailer or tow vehicle wiring to the motorhome light system. The “pigtail” assembly with the (car/trailer end) connector plug should be wired by a qualified technician.

The trailer brake controller connector is located to the left of the steering column.

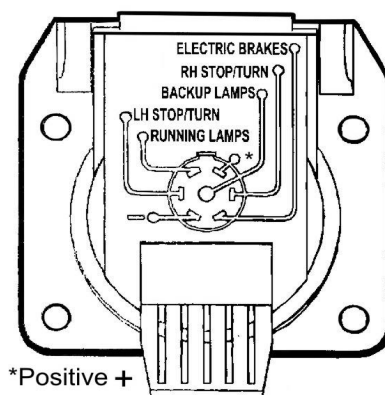

## TOWING GUIDELINES

### Gross Vehicle Weight Rating (GVWR)

This is the maximum allowable weight of the fully loaded vehicle. Included are fuel, water, LP, passengers, cargo, tools, and optional equipment installed by the motorhome manufacturer, dealer, or owner. This value is found on the VIN label, typically placed near the driver position.

### Gross Axle Weight Rating (GAWR)

This is the total weight a given axle is capable of carrying, measured at the ground. Each axle has its own rating. These values are also found on the Vehicle Certification Label: front and rear.

### Gross Combination Weight Rating (GCWR)

This is the maximum allowable weight of the motorhome and loaded trailer, including the items noted in GVWR above. For purposes of

this definition, the “trailer” can be a trailer, a vehicle towed on a dolly, or a vehicle towed by means of a tow bar. GCWR is typically specified based on durability and performance of the tow vehicle drive train: engine and cooling systems, transmission, drive line, drive axle, and others. The tow vehicle brakes may be rated for operation at GVWR, not GCWR.

*NOTE: State or provincial laws/regulations may require the “trailer” to be equipped with brakes that are activated when the motorhome brakes are applied. **The user is responsible to know and understand the laws of the state or province being traveled.** The Department of Transportation in a given state or province should be able to provide specific information.*

## Hitch Ratings

SAE Standard J684 defines:

- Class 1 trailers as “GVWR not to exceed 2,000 lbs”.
- Class 2 trailers as “GVWR over 2,000 lbs. and not to exceed 3,500 lbs. GVWR”.
- Class 3 trailers as “GVWR over 3,500 lbs. and not to exceed 5,000 lbs. GVWR”.
- Class 4 trailers as “GVWR over 5,000 lbs. and not to exceed 10,000 lbs. GVWR”.

Hitches are to be permanently marked with “Maximum trailer GVWR to be drawn” and “Maximum vertical tongue weight to be imposed.” The SAE standard does not specify a vertical load rating.

Traditionally, hitches are labeled 3,500/350 as Class 2, 5,000/500 as Class 3, and 10,000/1,000 as Class 4. The vertical tongue load value of 10 percent of drawn rating comes from the collective experience that 10 percent is the minimum value that provides stable towing of a trailer.

Ford’s towing guide suggests 10 to 15 percent for trailers over 2,000 lbs. Within GCWR, a Class 3 hitch allows “dingy” towing a large car or

mid-size SUV; a Class 4 hitch allows “dingy” towing a large SUV or pickup. (Hitch ratings are independent of towing vehicle ratings.)

*NOTE: Some Winnebago Industries® models equipped with a Class 3 hitch may have a label limiting vertical tongue load to 350 lbs. Some Winnebago Industries models equipped with a Class IV hitch have a label limiting vertical tongue load to 500 lbs. On a 228" wheelbase, a 500-lb. load on a hitch 11' from the rear axle will apply about 800 lbs. at the axle.*

The user must verify that the hitch equipment being used is adequate for the application.

---

---

## GEAR GARAGE

The Gear Garage offers near limitless possibilities in regard to customization and storage. Consisting of Retention Hooks, MOLLE panels, and the wall and ceiling of the compartment has supporting brackets installed to allow for attachment of various shelving, cabinets, etc. The floor in the Gear Garage was tested for loads of up to 1,000 pounds (evenly distributed). Please follow all loading and weighing of the loaded vehicle as outlined earlier in this section. See below for additional details.

### Gear Garage Retention Rings

The Gear Garage contains 4 tracks with retention rings that can be moved to a desired location to tie down various objects in the Gear Garage. The rings are moved by pulling out on the ring while pushing down on the base of the ring to unlock and move to another location on the track.

## SECTION 11 – MISCELLANEOUS

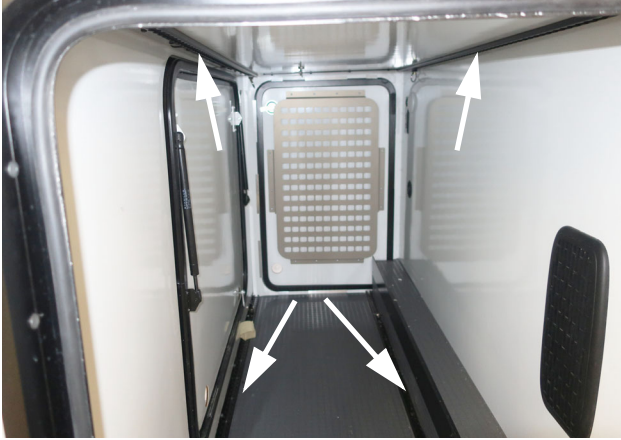

The 4 Retention Track locations. Picture shown from the passenger side access door.  
-Typical View



MOLLE Panel on the Driver side Gear Garage access door.  
-Typical View



View of one of the retention hooks. Pull out on the ring while holding down the base to unlock and move to another location on the track.  
-Typical View



MOLLE Panel on the Passenger side Gear Garage access door.  
-Typical View

### MOLLE Panels

The MOLLE panels offer the ability to attach various objects or MOLLE equipped travel gear for extra storage and convenience. These panels have been tested to support up to 25 pounds (evenly distributed). There are 2 large panels located in the Gear Garage on the driver and passenger side access doors.

### Internal Wall and Ceiling Support brackets

In production of this motorhome, steel support brackets were installed inside the walls that can be used to screw in various objects such as shelving, cabinetry, etc. **Do Not** use screws longer than 3/4 inch to avoid puncturing something on the other side. The brackets are hidden inside the wall, exact location can be pinpointed using a magnet. Shown below is a drawing of the approximate locations of the brackets, as well as a picture of the wall and ceiling.

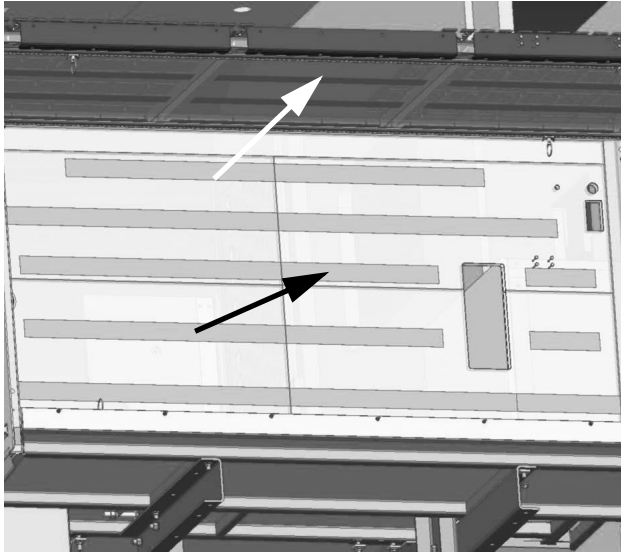

A cut away drawing with the back wall removed. The brackets run horizontal on the inside wall and on the ceiling. Shown in darker shades. These are not visible. Locate these brackets using a magnet.

-Typical View

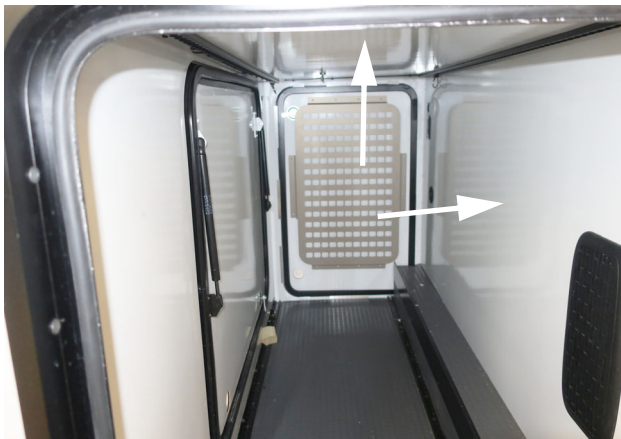

The hidden support brackets are located on the wall and the ceiling in the Gear Garage. (Use a magnet to locate.)

-Typical View

---

## **MANUAL AWNING**

**-If Equipped**

(Typical View – Your motorhome may differ in appearance)

The Manual awning is a bat wing design that wraps around the drivers side and the back of the coach.

### **Further Information**

See the awning instructions in your InfoCase for additional information.



- The manual awning is located on the drivers side rear of the motorhome. Start by unzipping the awning. The awning case remain permanently attached to the side of the motorhome.

-Typical View



- After unzipping and exposing awning, release the velcro retention straps.

-Typical View



## SECTION 11 – MISCELLANEOUS

---



- The awning body will release downward.  
-Typical View



- The end strap slides into the retention bracket and can be tightened using the strap.  
-Typical View



- On the end closest to the drivers side, pull the awning outward and it will reach around to the backside of the motorhome.  
-Typical View



- Extend the support leg downward. The leg can be adjusted for height. Reverse the steps to place the awning back into travel configuration.  
-Typical View



- In the rear of the motorhome, there is an awning retention bracket.  
-Typical View

---

## POWER AWNING

### -If Equipped

The Power Awning and Awning Light switches are located near the entrance door.

*Note: Adjustments made to the factory settings may affect performance.*

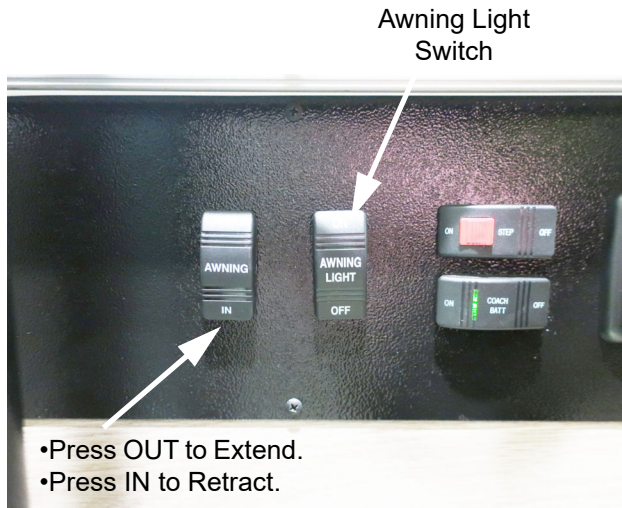

Power Awning and Awning Light Switches  
(Located near entrance door.)  
-Typical View

**⚠ CAUTION**

Pinch Hazard. Ensure there are no people who could be harmed or objects that can be damaged. Failure to heed this warning could result in severe injury and/or property damage.

### Operating the Awning

- Press and Hold the Power Awning switch IN or OUT to extend or retract the awning as desired.
- The Awning Light Switch will illuminate the area around the awning.

### Ignition Lockout System

The Ignition Lockout System will disable the extend function while the vehicle ignition key is in the On position. With this feature, the Awning will only extend when the vehicle ignition key is in the Off position. The Awning can retract anytime regardless of the ignition key position.

### Awning Motion Sensor

The awning has a wind motion sensor that is powered by batteries. When the batteries die, there will be a beeping sound inside the coach indicating the need to replace them. The batteries are located in the lead rail on the motor side of the awning.

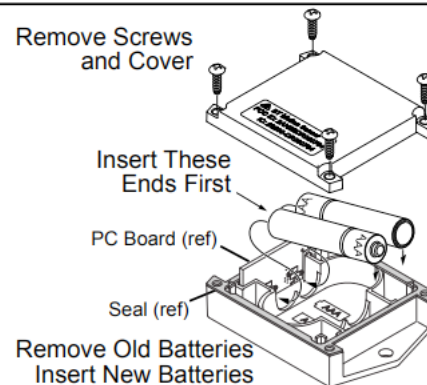
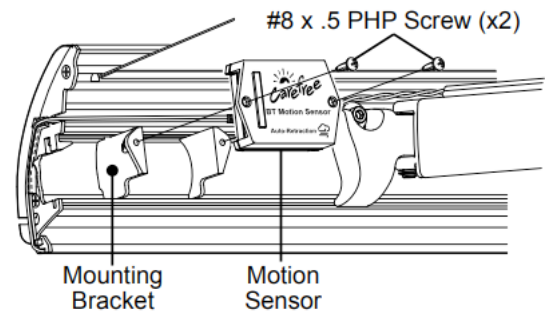

Awning motion sensor battery replacement  
(see below for details).  
-Typical View

To replace the batteries:

1. Remove the screws and the rear cover from the module.
  2. Remove the two batteries.
  3. Make sure that the contact tabs are clean and bent out for best contact.
  4. Insert new batteries. Match the new battery orientation with the old batteries.
- Tip: Place the battery end next to the PC board first then swivel the other end into the case. This will set the batteries firmly into the case.
5. Check that the seal is in place and flat, and then attach the rear cover with the screws removed previously.



## SECTION 11 – MISCELLANEOUS

---

6. To Test: Hold the sensor vertically with the Carefree logo upright, repeatedly move the sensor vertically up and down to simulate a brisk wind. The awning should retract. If the awning does not retract, it may be necessary to pair the sensor to the BT12 Module. Follow the steps below.

7. After the module works correctly, install the module on the bracket.

*NOTE: Bracket will be unattached in the lead rail. When the module is screwed onto the bracket it will tighten and bind in the lead rail.*

Pairing the motion sensor may be necessary for replacements and upgrades, the steps are as follows:

1. Extend the awning using the switches.
2. Place the awning in pairing mode.
3. Insert the batteries into the module.
4. Hold the motion sensor next to the control module. The device should pair within 90 seconds.

5. To Test: Hold the sensor vertically with the Carefree logo upright, repeatedly move the sensor vertically up and down to simulate a brisk wind. The awning should retract.

6. Mount the module.

### Further Information

For complete operating instructions, features, safety precautions, and maintenance care, refer to the Awning manufacturer's user guide provided in your InfoCase.

---

## STORAGE COMPARTMENT DOORS

The high-density gaskets used on the exterior storage compartments are designed to provide a more positive seal against dust and weather.

To ensure that exterior storage compartment doors have latched properly, press firmly on the bottom edges of the doors with the palms of your hands while twisting latches.

---

## ROOF LADDER

–If Equipped

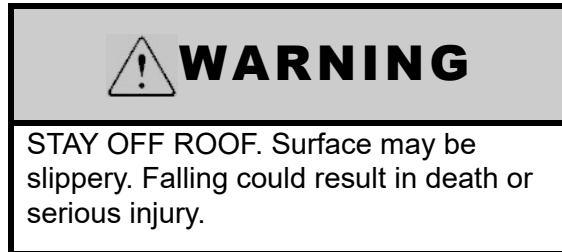

The ladder on your vehicle is provided for limited access to the roof.

Walking or working on the roof should be left to qualified service personnel using proper safety equipment in a safe environment. You should only walk or work on the roof if you are qualified and have created a safe environment.

For your safety, it is not recommended that you store or carry items on the roof.

### Before Using the Ladder

- **Inspect the ladder** to make sure it is not damaged. Never use a damaged ladder.
- **Keep the rungs of the ladder clean and dry** while in use. Never use the ladder when it is raining, snowing, or icy. The rungs can become slippery. Do not step onto the rungs if the rungs are wet, or if your shoes are wet or carry mud or debris that could result in a loss of footing.
- **Never ignore warning labels** or weight limits defined on your ladder. The following warning label is located on or near the ladder:

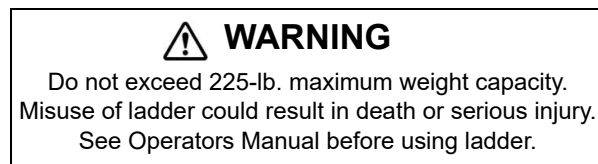

- **Maximum Capacity: 225 lbs.**
- **Do not overload.** Ladder is intended for one person.

- **Make sure you are physically capable** to safely use the ladder. Strength, flexibility, and stability are required.
- **Be aware that the vehicle may sway** as you climb the ladder. Do not use the ladder in high winds.
- **As you climb the ladder**, grasp the side rails firmly and always use both hands. Keep your body centered between the side rails. Do not over-reach.
- **Never allow children** on the ladder.
- **Do not transport items** anchored to the ladder. You could damage the ladder.

---

---

## **POWER ROOF VENTILATOR**

The Power Roof Ventilator features a rain cover, electric lift, and thermostat operation with exhaust airflow.

*NOTE: In event of power failure, the ventilator dome may be opened or closed manually using the Dome Crank knob.*

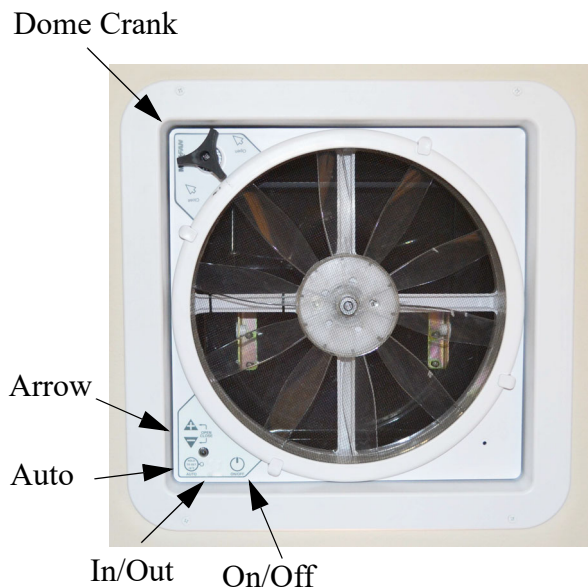

Power Roof Ventilator

- **ON/OFF** – Press to turn the fan on or off. The vent lid will open automatically when the fan is turned on and close when the fan is turned off.

- **IN/OUT** – Press to reverse the direction of the fan. The fan will slow down and pause for two (2) seconds before resuming operation in the opposite direction.
- **AUTO** – Press to enter Auto Mode. You will hear three (3) quick beeps to confirm the fan is in Auto Mode. To exit Auto Mode, press the On/Off button.
- **ARROW** – In Auto Mode press the +/- arrow buttons to adjust thermostat temperature up or down. Press the +/- arrow buttons at the same time to open or close the vent lid.

*NOTE: For best results, close all other roof vents, windows, and doors, then open one (1) window the farthest distance from the roof ventilator. The fan speed selector allows you to control the amount of circulation you need at any time.*

## **Further Information**

See the power ventilator manufacturer's operating instructions supplied in your InfoCase for further instructions, care, and cleaning information.

---

---

## **LUGGAGE RACK**

### **–If Equipped**

Your motorhome may be supplied with a Luggage Rack mounted on the roof of the vehicle.

- **Maximum Capacity of Luggage Rack:**  
200 lbs. evenly distributed over all roof rails.  
Each roof rail will support 40 lbs. of weight.



## **WARNING**

**STAY OFF ROOF.** Surface may be slippery. Falling could result in death or serious injury.

## SECTION 11 – MISCELLANEOUS

---

---

### WINDOWS

#### Push-Out Windows

The bedroom and lounge windows are secured by four safety latches at the sides and bottoms of each window.

To open window, release all four window latches and push open.

1. Side Latches (2) - Push center tab and pull down toward bottom of window frame.
2. Bottom Latches (2) - Push center tab and pull toward the left-hand side of the window frame.
3. Push window open.

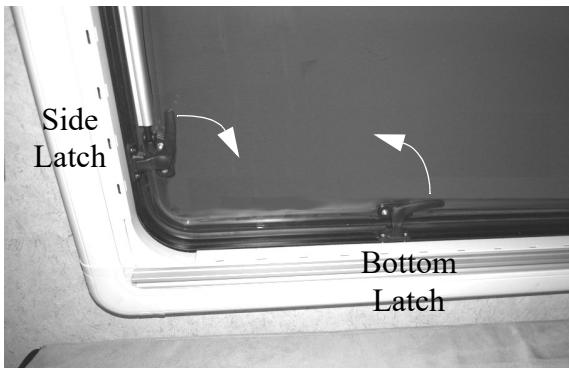

View of interior left-hand side of window  
-Typical View

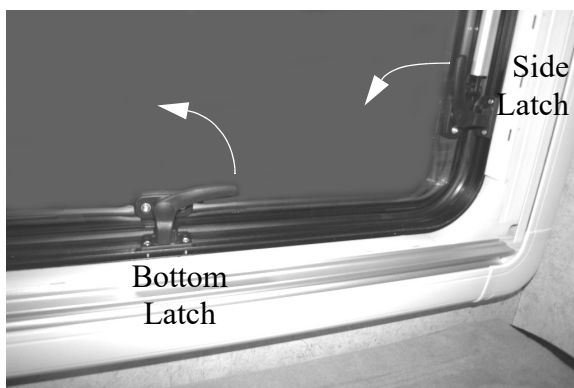

View of interior right-hand side of window  
-Typical View

#### Propping the Windows Open

The bedroom and lounge windows are featured with prop rods on each side of the window. These rods have three notches to prop your windows open at. Push window open slowly and stop at the preferred notch setting.

#### Closing the Windows

To close window, extend all the way out (past the third notch setting) and the window will retract. Grab one of the window latches and pull window toward you and secure all four latches into locked position.

---

---

### EFFECTS OF PROLONGED OCCUPANCY

Your motorhome was designed primarily for recreational use and short-term occupancy. If you expect to occupy your motorhome for an extended period, be prepared to deal with condensation and humid conditions that may be encountered.

#### Humidity and Condensation

Moisture condensing on the inside of windows is a visible indication that there is too much humidity inside the motorhome. Excessive moisture can cause water stains or mildew, which can damage interior items such as upholstery and cabinets.

When you recognize the signs of excessive moisture and condensation in your motorhome, you should take immediate action to minimize their effects.

You can help reduce excessive moisture inside the motorhome by taking the following steps:

#### Ventilate with outside air

Partially open one or more windows and a roof vent to circulate outside air through the motorhome. In cold weather, this ventilation may increase use of the furnace, but it will greatly reduce the condensation inside the motorhome.

**Minimize moisture released inside the motorhome**

Run the range hood fan while cooking and open a bath vent while bathing or showering to carry water vapor out of the motorhome. Avoid making steam from boiling water excessively or letting hot water run. Avoid bringing extra moisture into the motorhome by way of soaked clothing or snow on shoes. Do not hang-dry wet overcoats or clothing inside the motorhome.



# INDEX

---

About this Manual .....	1-1
Access Port (Roof) .....	8-3
Air Conditioner/Heater – Automotive (Dash) .....	3-5
Audio/Video System Basic Operation .....	8-1
Bathroom .....	10-8
Battery Access .....	6-8
Battery Boost Switch .....	3-5
Bed – Deluxe Sleep System .....	9-3
Before Driving .....	1-2
Blind Spot detection system .....	3-3
BLUE-RAY DISK™ Player With dvd .....	8-1
Cab Seat Lounge Cushion .....	9-1
Cabinetry – Cleaning .....	10-6
Car or Trailer Towing .....	11-3
Carbon Monoxide Alarm .....	2-5
Carbon Monoxide Warning .....	2-5
Chassis Service and Maintenance .....	10-11
Child Restraints .....	3-2
Circuit Breakers – House 120-Volt AC .....	6-4
Circuit Breakers and Fuses – House 12-Volt DC .....	6-9
Cold Water Filter .....	7-4
Decorative Vinyl Wall Paneling – Cleaning .....	10-6
Dinette Table .....	9-2
Dinette Table (Portable) .....	9-1
Disinfecting Your Fresh Water System .....	7-5
Doors and Windows .....	10-9
Driving Safety .....	2-2
Ducted Roof Air Conditioning System .....	4-10
Effects of Prolonged Occupancy .....	11-12
Electrical .....	2-6
Electrical Cautions .....	6-1
Electrical Generator .....	6-5
Electrical Outlets – House 120-Volt AC .....	6-4
Electrical System – House 120-Volt AC .....	6-1
Emergency Exits .....	2-7
Engine Cooling System .....	3-6
Engine Overheat .....	2-10
Exterior Automotive Paint Finish .....	10-2
Exterior Graphic Care .....	10-4
Exterior Lights .....	10-5
Exterior Shower/Wash Stations .....	7-7
Fire Extinguisher .....	2-6

---



# Index

---

Formaldehyde Information .....	2-7
Fresh Water System .....	7-1
Front Axle Tire Alignment .....	1-2
Fuel and Propane Gas .....	2-2
Gear Garage .....	11-5
General Warnings .....	2-1
Ground Fault Circuit Interrupter .....	6-4
Hazard Warning Flashers .....	3-4
Headlight Alignment .....	1-2
Heating System – Furnace .....	4-8
House/Coach Battery Disconnect Switch .....	6-8
Interior Soft Goods .....	10-5
Inverter/Charger Unit – 2000W (Pure Sine Wave) .....	6-2
Jump Starting .....	2-10
Keys .....	3-3
Lights .....	3-6
lithium Battery .....	6-6
Loading .....	2-7
Loading the Vehicle .....	11-1
Luggage Rack .....	11-11
Maintenance .....	2-7
Manual Awning .....	11-7
Microwave Oven .....	4-3
Mirrors – Power Exterior .....	3-4
Mold, Moisture, and Your Motorhome .....	2-8
Motorhome Maintenance Chart .....	10-12
Occupant and Cargo Carrying Capacity Label .....	1-3
Owner and Vehicle Information .....	1-6
Plastic Parts – Cleaning .....	10-5
Pop-top Sleep System .....	9-3
Power Awning .....	11-8
Power Cord – External (Detachable) .....	6-1
Power Roof Ventilator .....	11-11
Pre-Delivery Inspection .....	1-2
Propane Gas Leak Detector .....	2-4
Propane Gas Leaks .....	2-4
Propane Gas Pressure Regulator – Removable LP Tank .....	5-5
Propane Gas Supply .....	5-1
Propane Gas Warnings and Precautions .....	5-4
Propane Vaporization in Cold Weather .....	5-5
Radio – In-Dash .....	3-5
Range and Refrigerator .....	10-7
Range Top .....	4-2
Rearview Mirror with Monitor System .....	3-5
Refrigerator .....	4-1

---

---

Reporting Safety Defects .....	1-2
Roadside Emergency .....	2-9
Roof .....	10-1
Roof and Ladders .....	2-9
Roof Ladder .....	11-10
Safe Use of the Propane Gas System .....	5-3
Safety Messages Used in this Manual .....	1-1
Satellite Dish and Cable TV Connections (Input) .....	8-2
Sealants – Inspection and General Information .....	10-1
Seat Belts .....	3-1
Seats – Driver/Co-Pilot .....	3-1
Service and Assistance .....	1-2
Service Light .....	7-1
Shower Hose Vacuum Breaker .....	7-7
Sink – Stainless Steel .....	10-7
Sleeping Facilities .....	9-3
Smoke Alarm .....	2-6
Solar Charge Panel .....	4-7
Specifications and Capacities .....	1-5
Storage Compartment Doors .....	11-10
Suspension Alignment and Tire Balance .....	3-6
Systems Monitor Panel .....	4-6
Tables and Countertops .....	10-7
Tailgate package (Model 622a) .....	4-3
Tires .....	3-6
Toilet .....	7-8
Towing Guidelines .....	11-4
Trailer Wiring Connector .....	11-4
TV Antenna – Digital .....	8-1
TV Digital Satellite System Wiring .....	8-2
TV Signal Amplifier .....	8-1
Undercarriage .....	10-2
Vehicle Certification Label .....	1-4
Vehicle Storage – Preparation .....	10-9
Vehicle Storage – Removal .....	10-10
Vehicle Usage In Cold Weather .....	10-9
Vinyl Flooring .....	10-7
Waste Water System (MODEL 622A) .....	7-9
Water Heater – Gas Tankless with Decalcification .....	4-9
Water Pump .....	7-2
Water System Drain Valve Locations .....	7-22
Waterline & Tank Drain Valves .....	7-10
Weighing Your Loaded Vehicle .....	11-1
Windows .....	11-12
Winterizing Procedure .....	7-10

---

**Index**

---

Wood Furniture and Cabinetry ..... 9-6

---